



Booklet available in English on  
Heft in deutscher Sprache erhältlich auf  
Livret disponible en français sur  
Libretto disponibile in italiano su  
Folleto en español disponible en  
如需中文版手册, 请访问



FR

**DONNEZ  
OU  
RECYCLEZ**



ASSOCIATION  
OU



MAGASIN  
OU



DÉCHÈTERIE

Adresses sur [quefairemesdechets.fr](http://quefairemesdechets.fr)



[LEGO.com/sustainable-packaging](http://LEGO.com/sustainable-packaging)

# LEGO® VIP

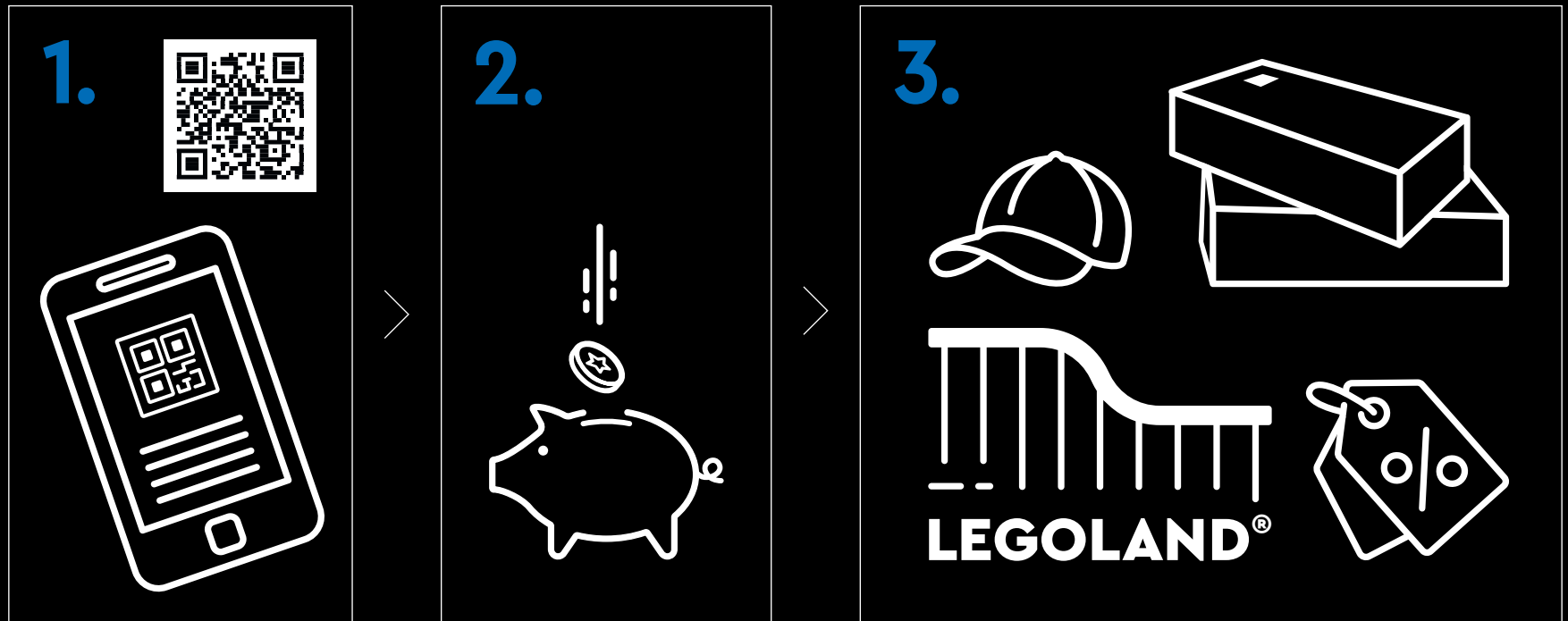

**1.** Sign up **2.** Earn points for purchases **3.** Redeem points for rewards, experiences, discounts & more | **1.** Melde dich an **2.** Sammle Punkte bei jedem Kauf **3.** Löse die Punkte für Belohnungen, Erlebnisse, Rabatte und Ähnliches ein | **1.** Inscrivez-vous **2.** Gagnez des points lors de vos achats **3.** Échangez vos points contre des récompenses, des expériences, des remises et bien plus encore | **1.** Iscriviti **2.** Guadagna punti con i tuoi acquisti **3.** Riscatta punti per premi, esperienze, sconti e altro ancora | **1.** Regístrate **2.** Gana puntos por tus compras **3.** Canjea puntos por recompensas, experiencias, descuentos y mucho más | **1.** Registe-se **2.** Ganhe pontos em compras **3.** Troque os pontos para prémios, experiências, descontos e muito mais | **1.** 注册 **2.** 购物赚积分 **3.** 用积分兑换奖励、体验、折扣等 | **1.** Zarejestruj się **2.** Zdobywaj punkty za zakupy **3.** Wymieniaj punkty na rabaty, przygody i inne nagrody | **1.** Zaregistrujte se **2.** Sbírejte body za nákupy **3.** Vyměňujte body za odměny, zážitky, slevy a spoustu dalšího | **1.** Zaregistrujte se **2.** Získavajte body za nákupy **3.** Uplatnite si body a získajte odmeny, rôzne zážitky, zľavy a ešte viac | **1.** Regisztrálj **2.** Szerezz pontokat minden vásárlással **3.** Váltsd be pontjaidat jutalmakra, élményekre, kedvezményekre és egyebekre | **1.** Înscric-te **2.** Câștigă puncte pentru achiziții **3.** Valorifică puncte pentru recompense, experiențe, reduceri și multe altele | **1.** Регистрируйте се **2.** Получайте точки за покупки **3.** Используйте точки за награды, услуги, отстъпки и т.н. | **1.** Reģistrējies **2.** Pelni punktus par pirkumiem **3.** Izmanto punktus, lai saņemtu balvas, izklaides iespējas, atlaides un daudz ko citu | **1.** Registreeru **2.** Teeni ostude eest punkte **3.** Lunasta punktide eest preemiad, elamused, allahindlused ja muu | **1.** Užsiregistruokite **2.** Pelnykite taškų už pirkinius **3.** Panaudokite taškus atlygiui, funkcijoms, nuolaidoms ir ne tik





## WELCOME TO RIVENDELL

20 years after the release of *The Return of the King™*, the spectacular *The Lord of the Rings™* trilogy remains one of the most significant works of film art of our time. How can you possibly choose a favourite scene or moment? In the darkest of times, Rivendell, the majestic home of the Elves, is a tranquil, flourishing haven of healing, hope, calm resolve and unification. In a pivotal meeting here, representatives of the peoples of Middle-earth forge *The Fellowship of the Ring™* to destroy the One Ring to Rule Them All.



*The fellowship of  
LEGO® Designers*

## A FELLOWSHIP OF LEGO® DESIGNERS

As part of a fellowship of model, element and graphic designers from around the world, we embarked on a journey to capture the magic of this place. Using soundstage blueprints from the films as a reference, we took some artistic liberties to combine our favourite features. This 6,000 LEGO® brick recreation of the iconic Imladris, The Last Homely House East of the Sea, is a detailed slice of Rivendell in LEGO minifigure scale, full of memorable story moments and beloved characters.



## CLASSIC SCENES FROM LEGO® THE LORD OF THE RINGS™

From the arrival of Gandalf the Grey™ in the Shire to the final battle against the King of the Dead on the shores of Minas Tirith, travel through some of the classic scenes from previous LEGO® *The Lord of the Rings*™ sets released in 2012-2013.



### 9469 GANDALF™ ARRIVES

*Gandalf the Grey travels to the Shire for the 111<sup>th</sup> birthday of his friend Bilbo Baggins. Here he meets young Frodo Baggins, and the adventure begins.*



### 79006 THE COUNCIL OF ELROND

*The people of Middle-earth have been summoned to Rivendell for The Council of Elrond. Here they will determine the fate of the One Ring.*



### 9473 THE MINES OF MORIA™

*The heroic Fellowship of the Ring faces evil Moria orcs and a giant cave troll in Balin's Tomb in the bone-chilling, abandoned Mines of Moria.*



**9474**  
**THE BATTLE OF HELM'S DEEP™**  
*The walled fortress at Helm's Deep and the people of Rohan are under attack by Saruman's barbaric Uruk-hai army.*



**10237**  
**THE TOWER OF ORTHANC**  
*The biggest LEGO® The Lord of the Rings™ set at the time of its release (with 2,357 parts) features six floors with iconic minifigure characters and scenes.*



**79008**  
**PIRATE SHIP AMBUSH**  
*Sauron's Mordor orcs prepare to greet their allies aboard the pirate ship, only to face Aragorn, Gimli, Legolas and the Army of the Dead instead.*



## THE TOWER

During his stay at Rivendell, Bilbo completes his book *There and Back Again* at his desk in the Tower. A secret hiding place at the Tower's base is just big enough to conceal a fugitive or keep the One Ring away from prying eyes.



*Frodo features dual-moulded legs to show his bare feet, a signature trait of Hobbits of the Shire. He also bears the One Ring, brought to Rivendell for the council to decide its fate.*

### FRODO BAGGINS



*Bilbo features a new 2-sided head decoration, including the frightening face he briefly reveals as he tries to take the Ring from Frodo.*

### BILBO BAGGINS





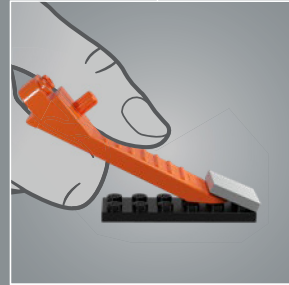
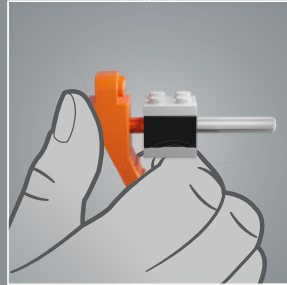
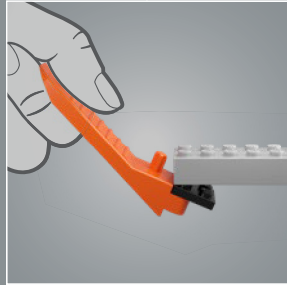
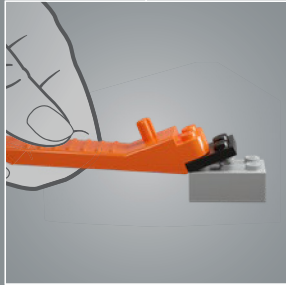
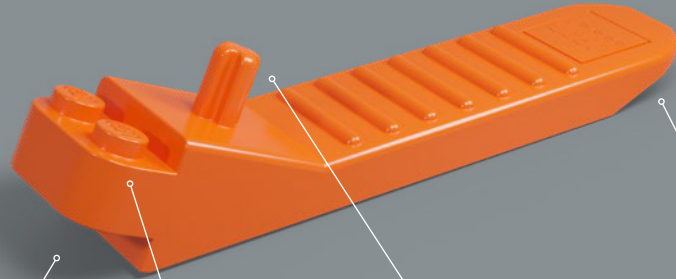

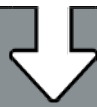

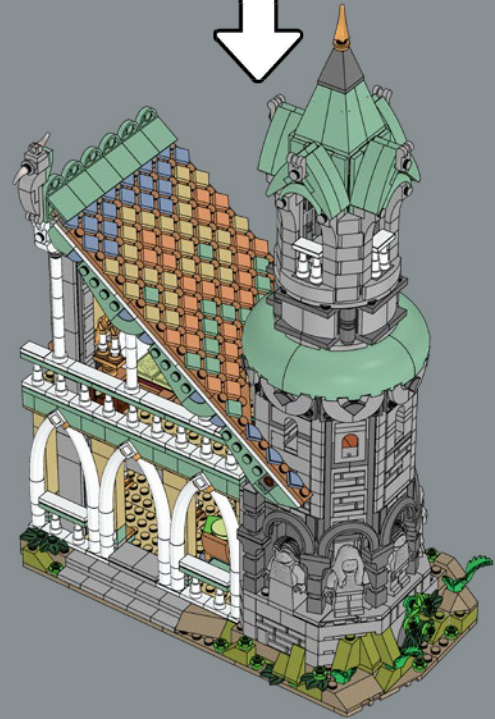



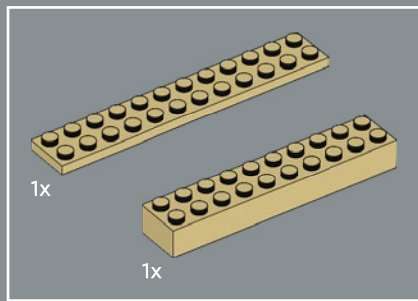

1

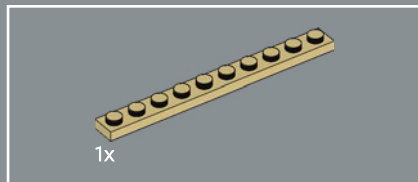
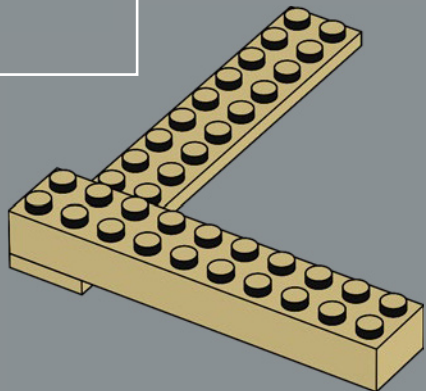

2

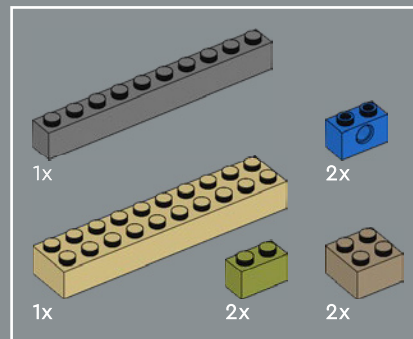
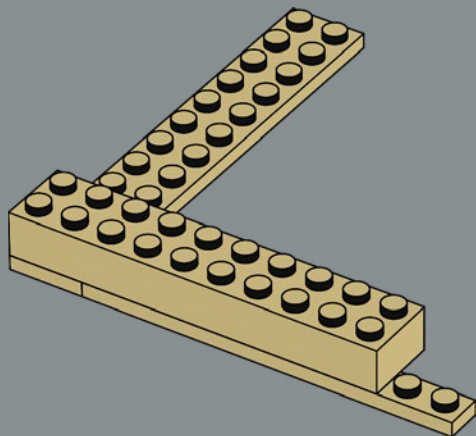

3

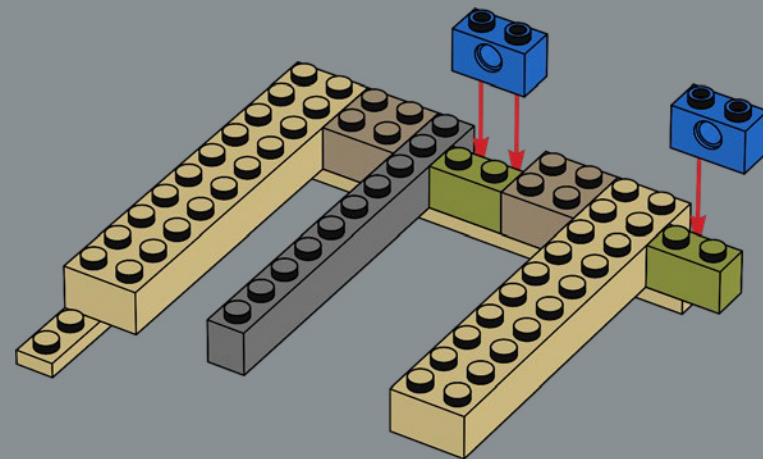

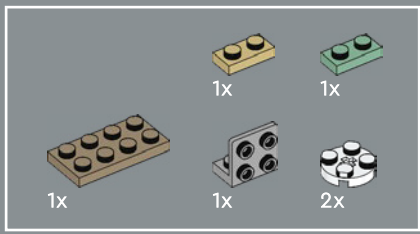

4

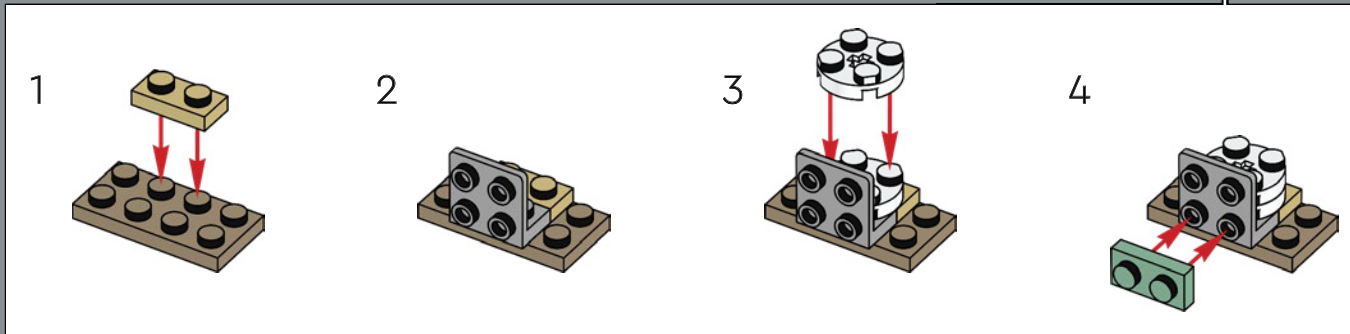
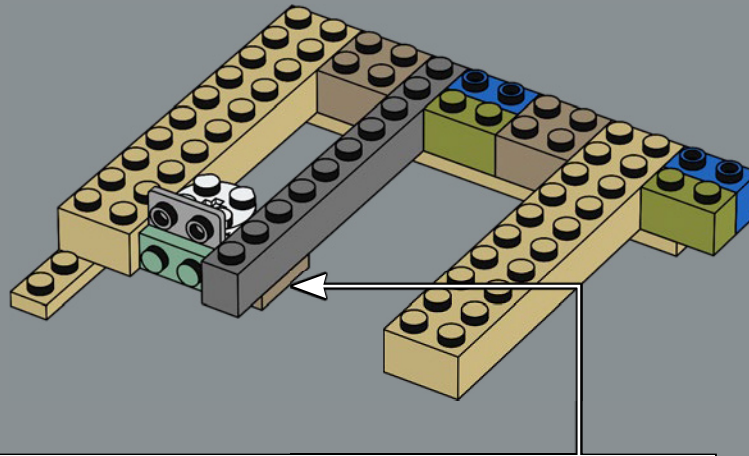

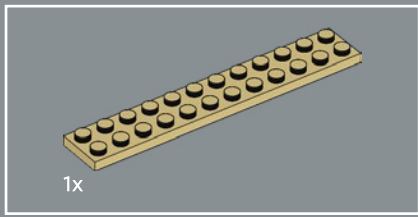

5

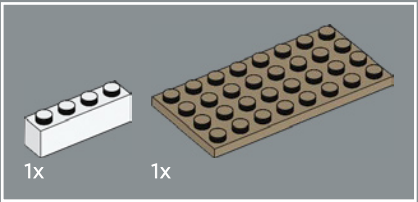
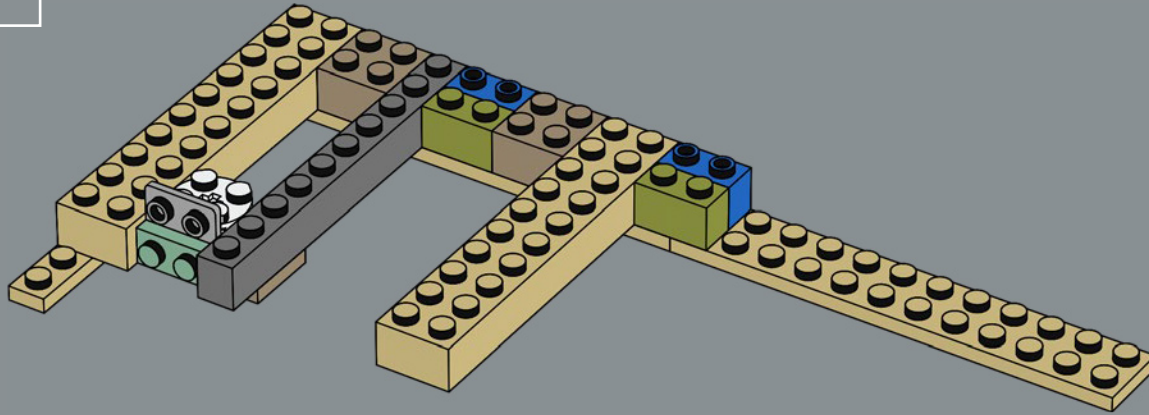

6

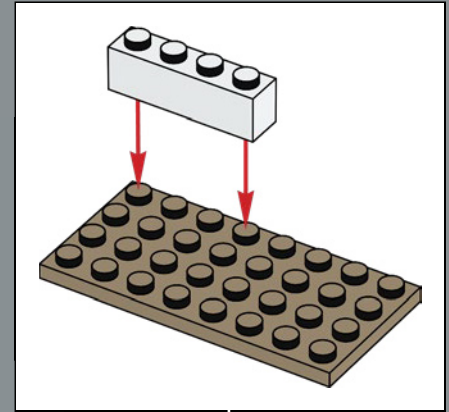
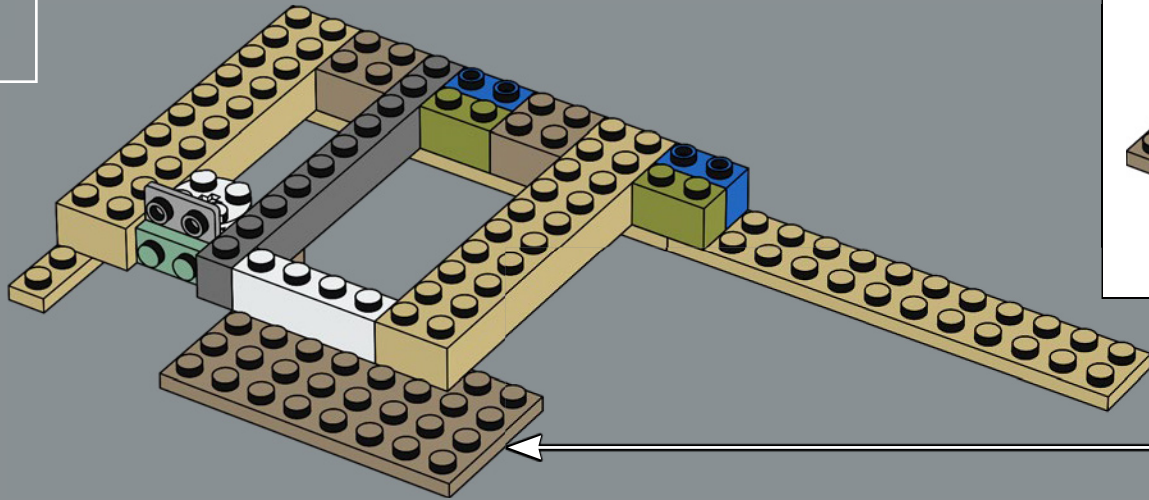

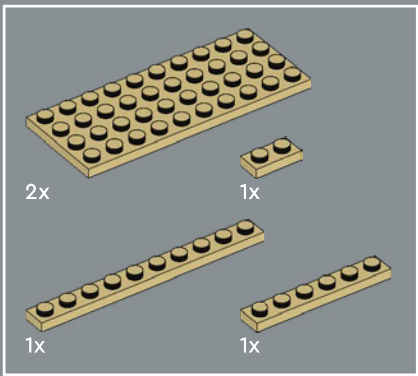

7

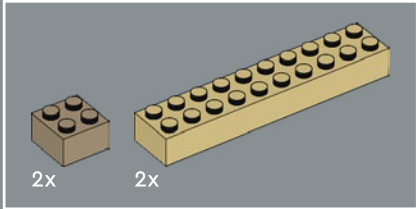
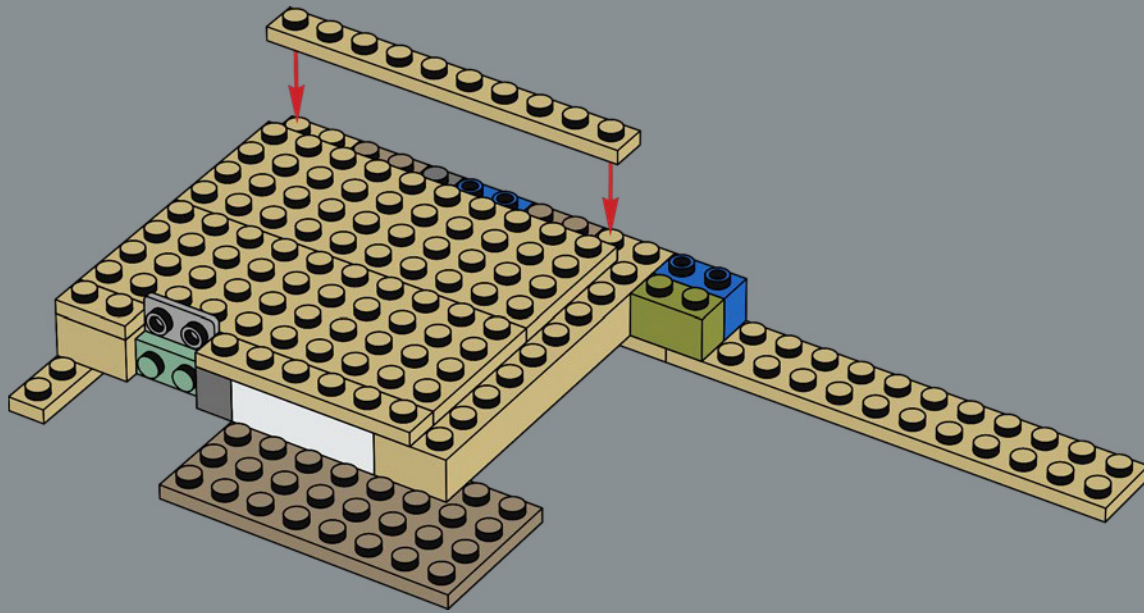

8

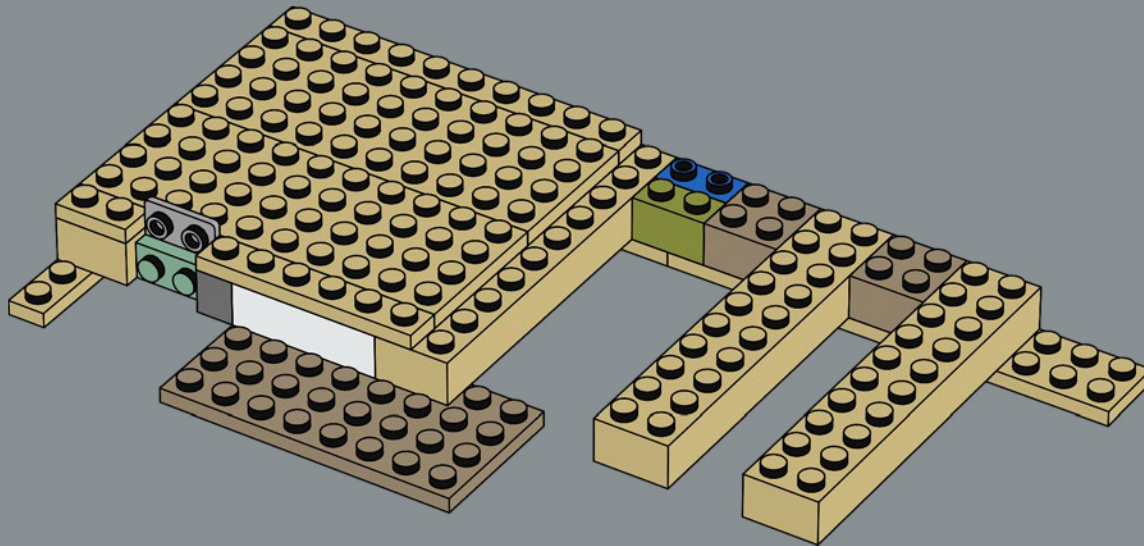



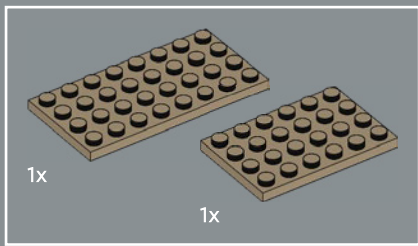

9

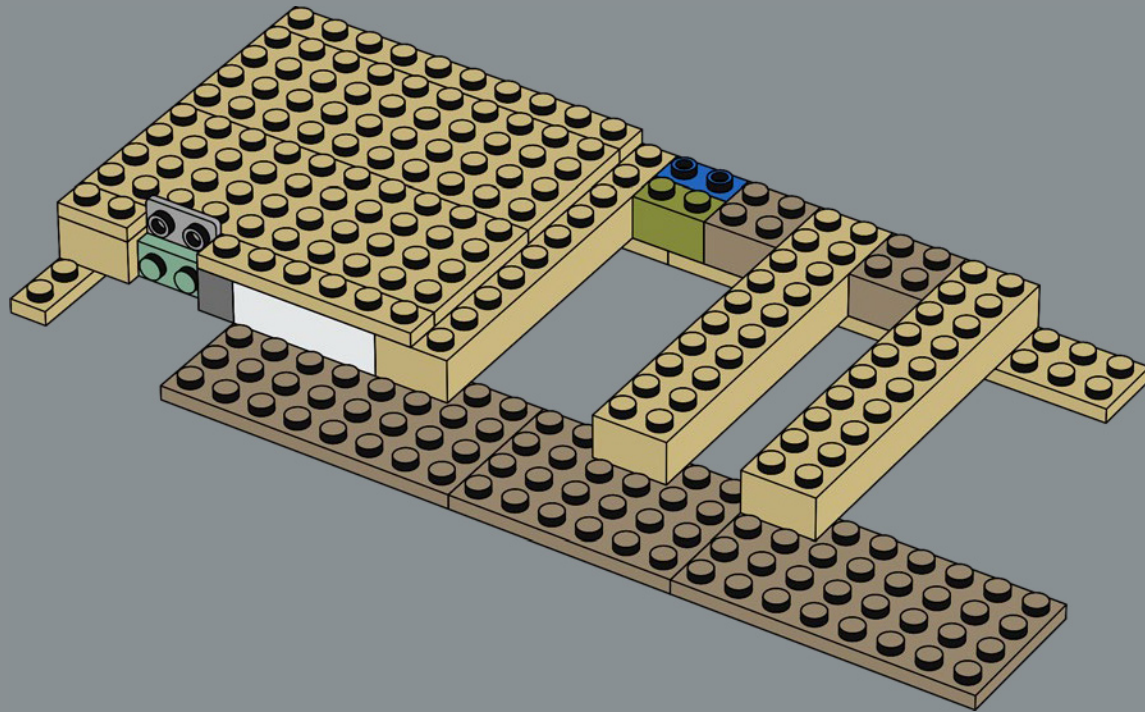

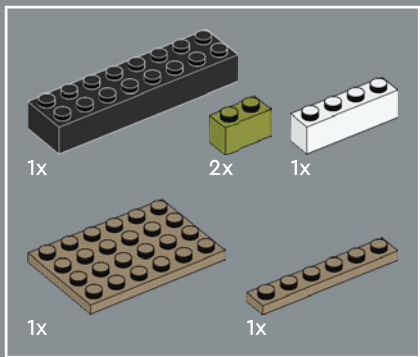

10

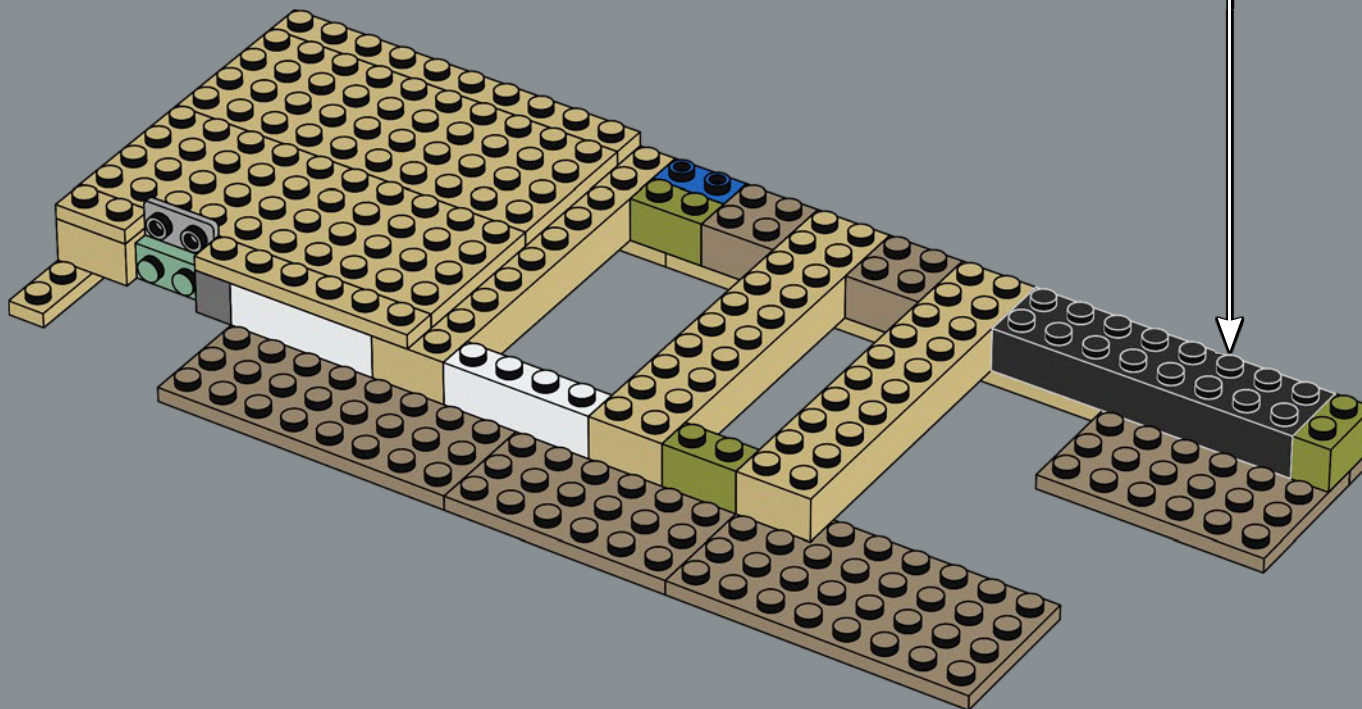
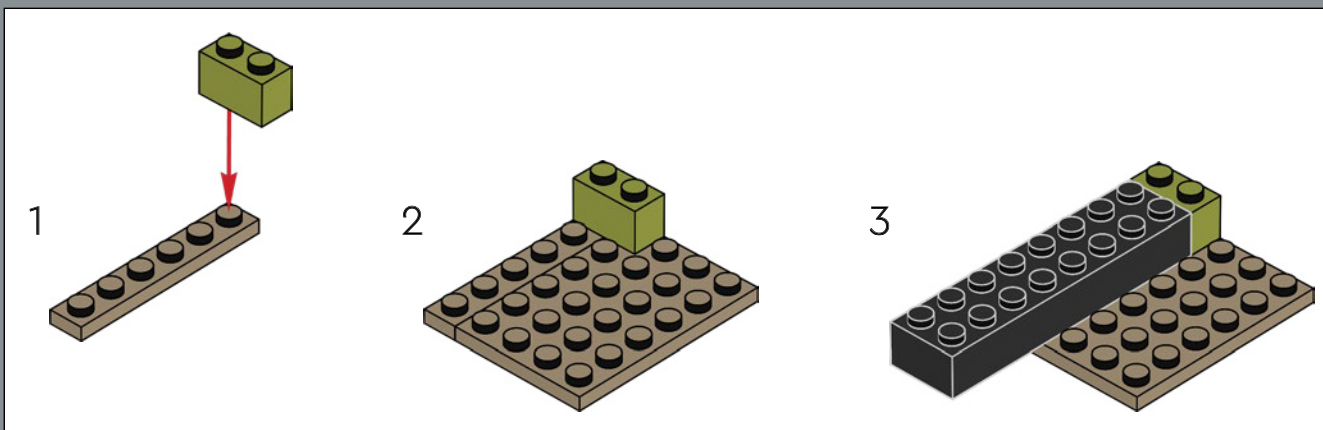

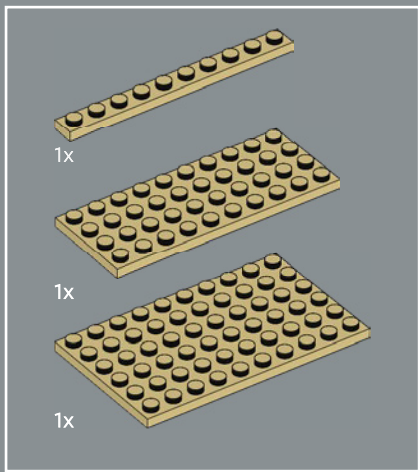

11

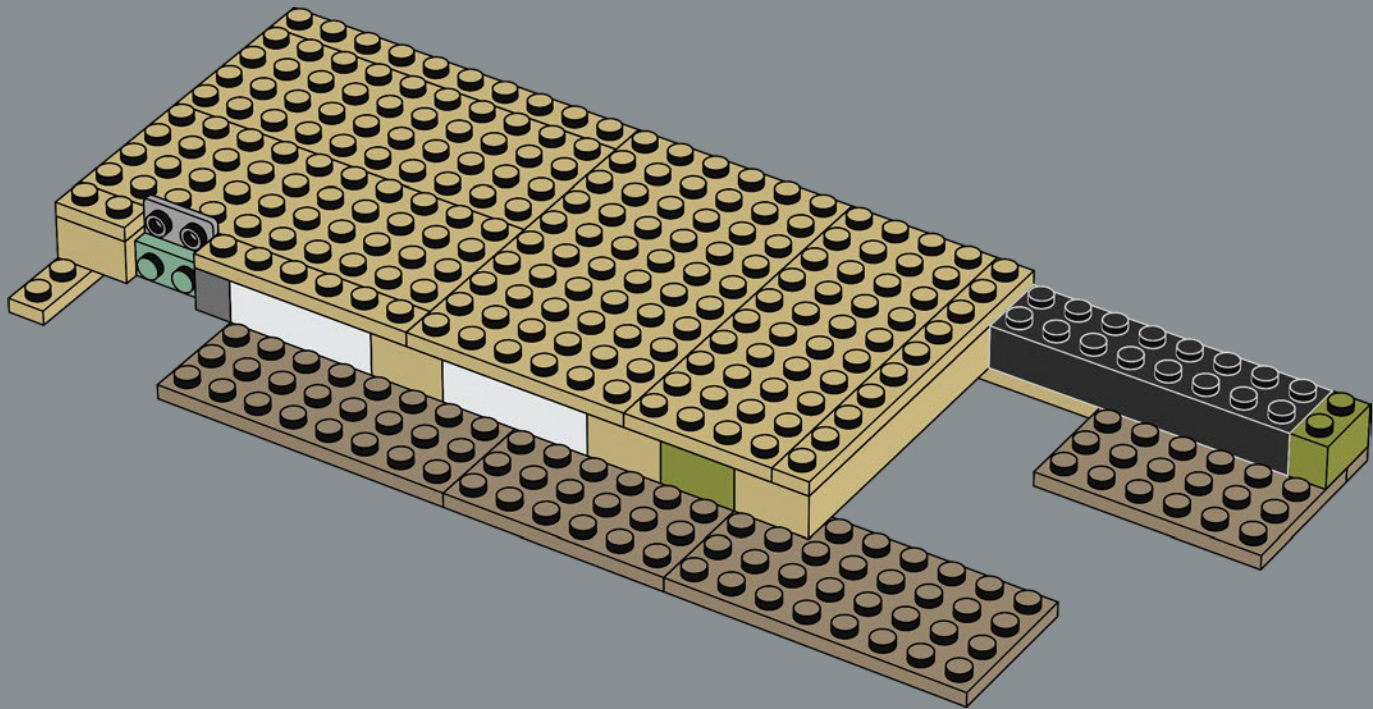

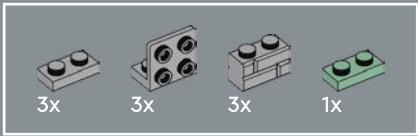

12

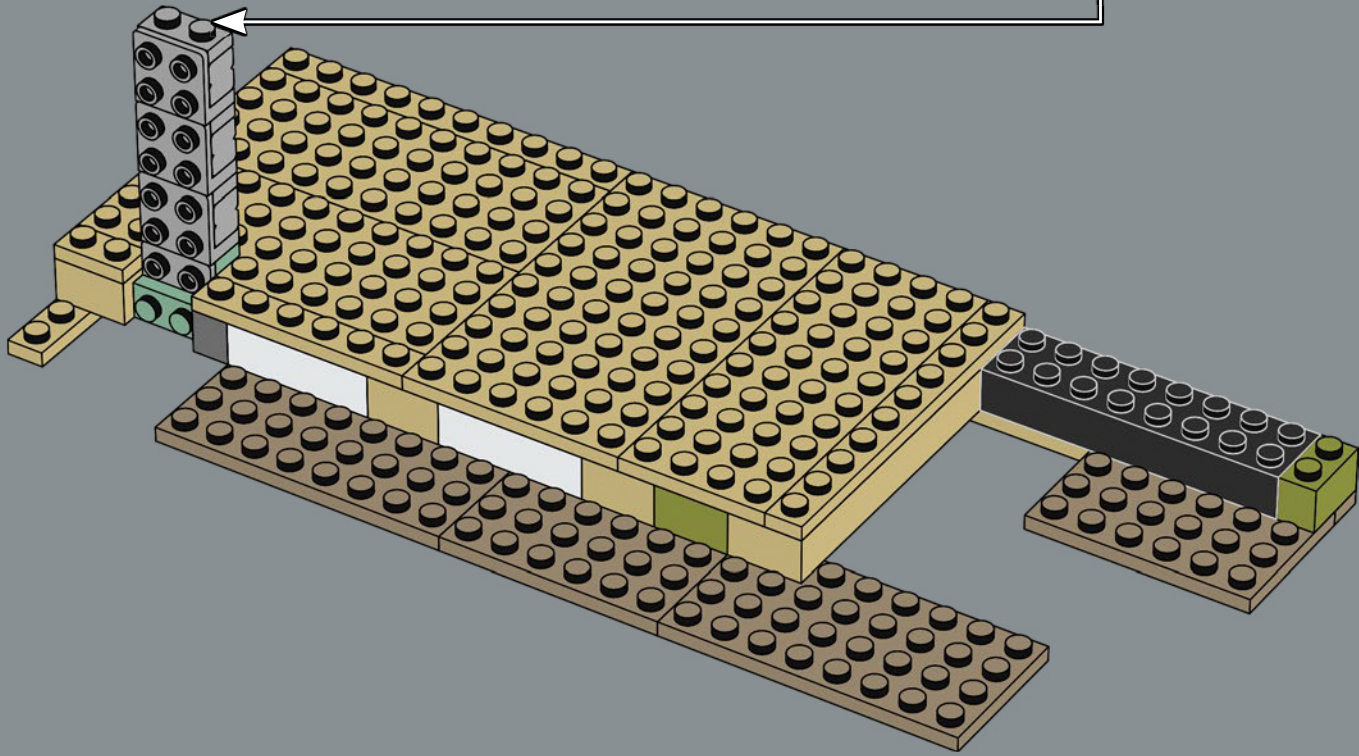
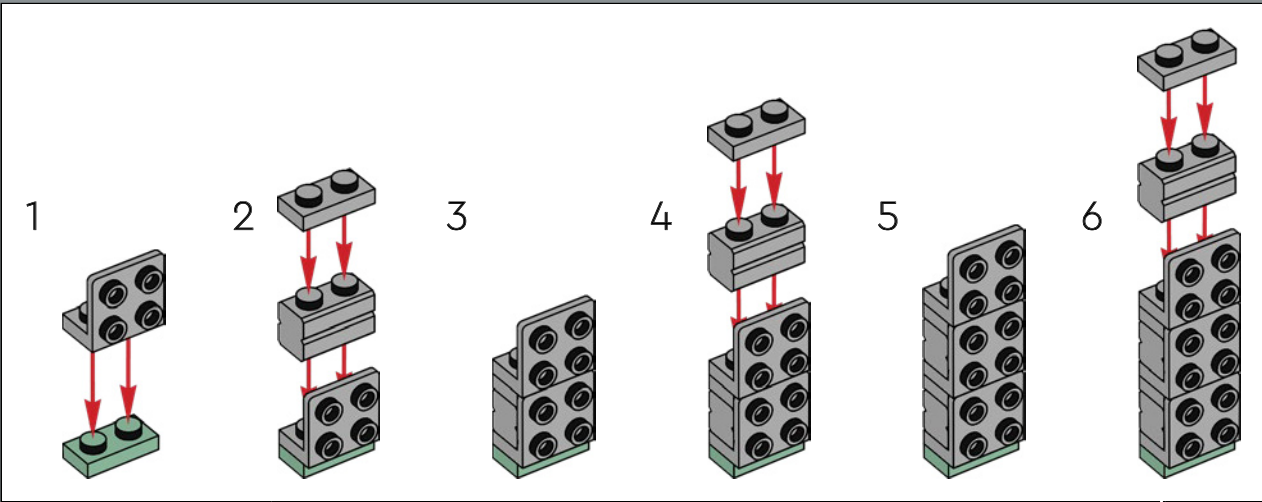

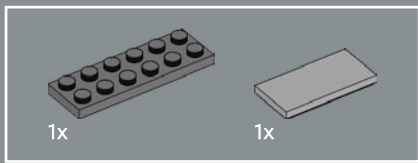

13

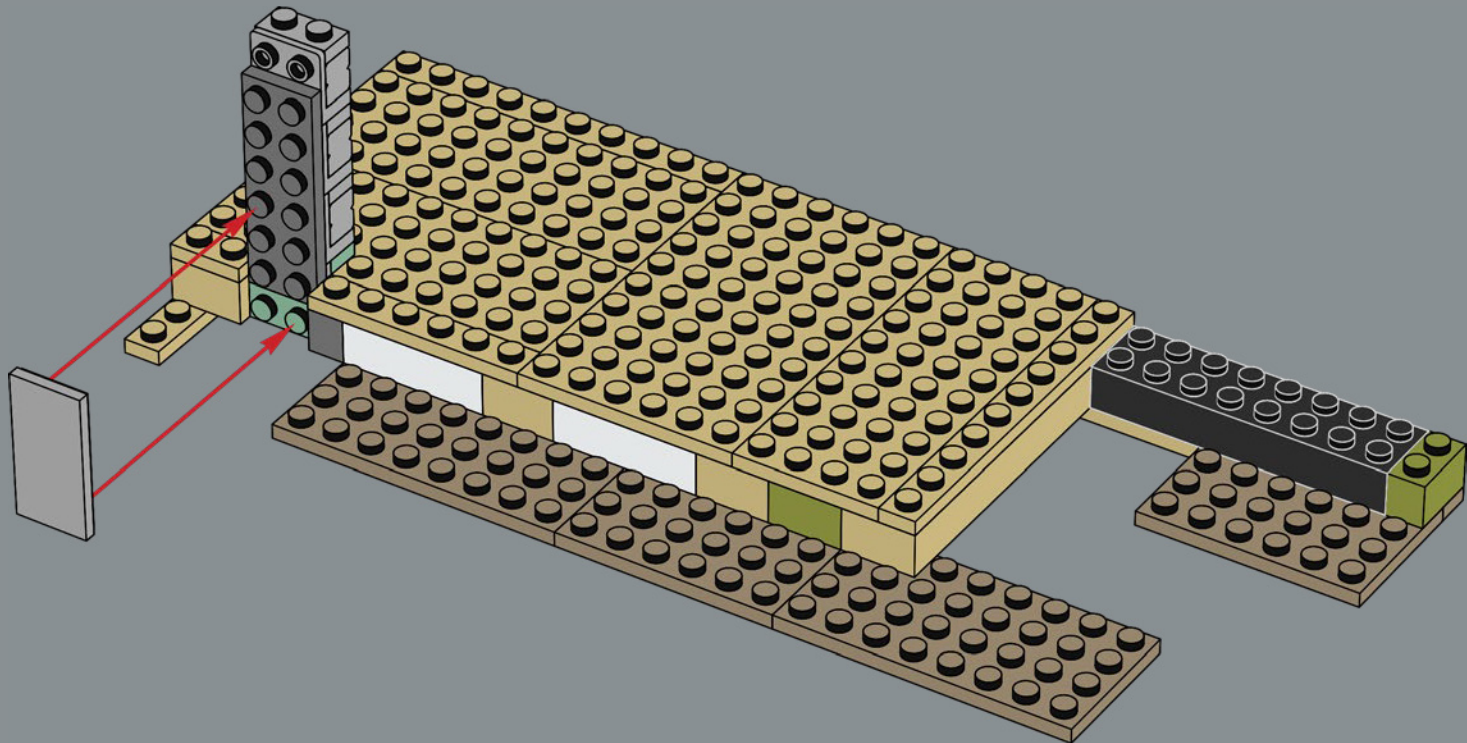

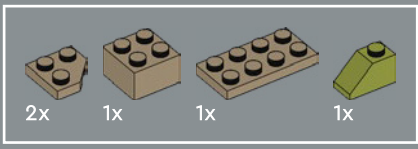

14

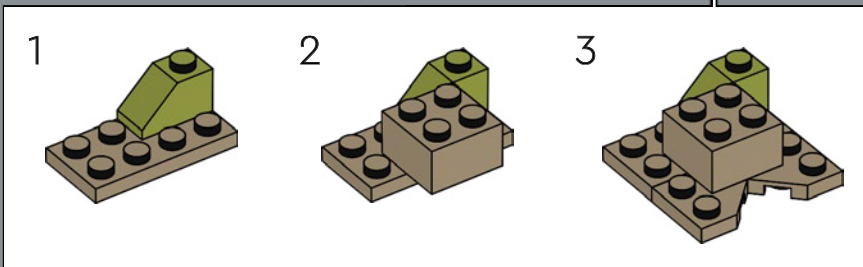
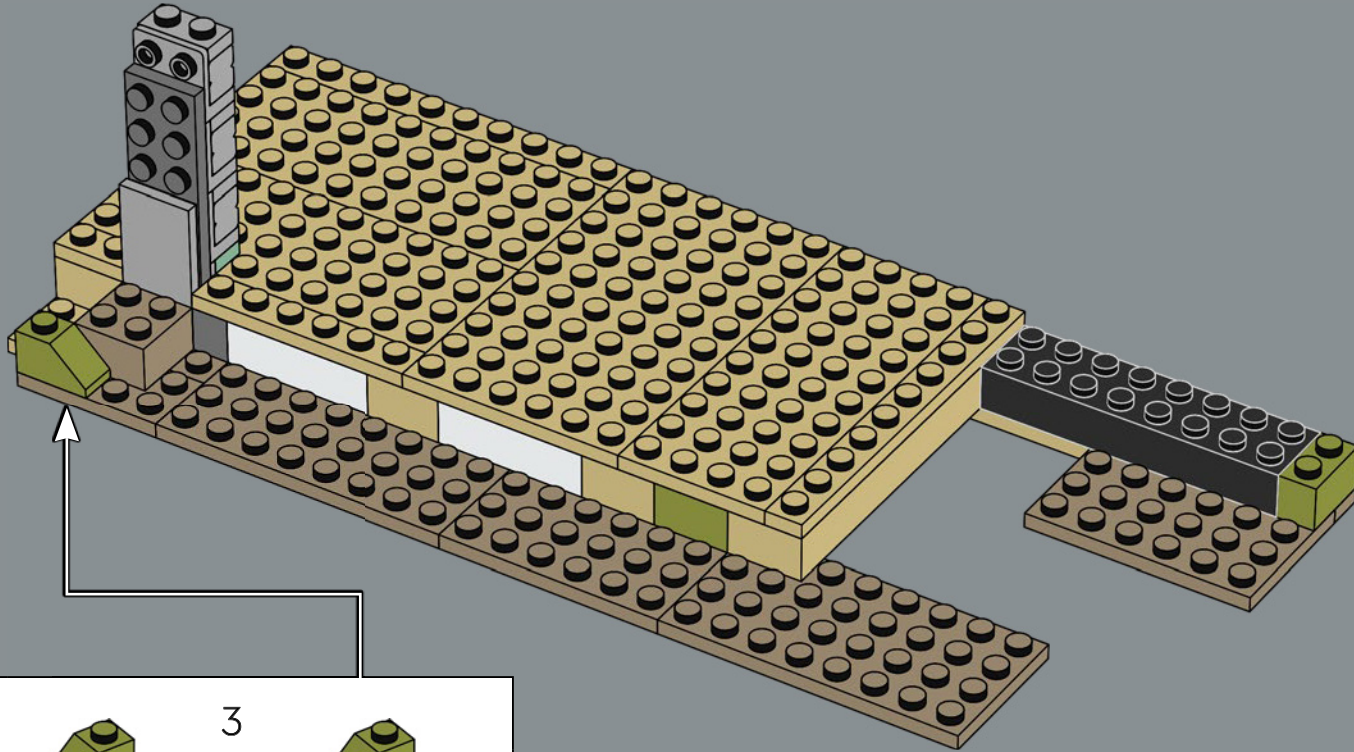

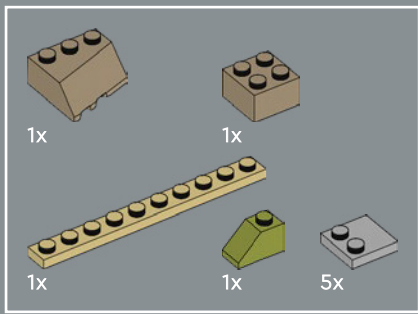

15

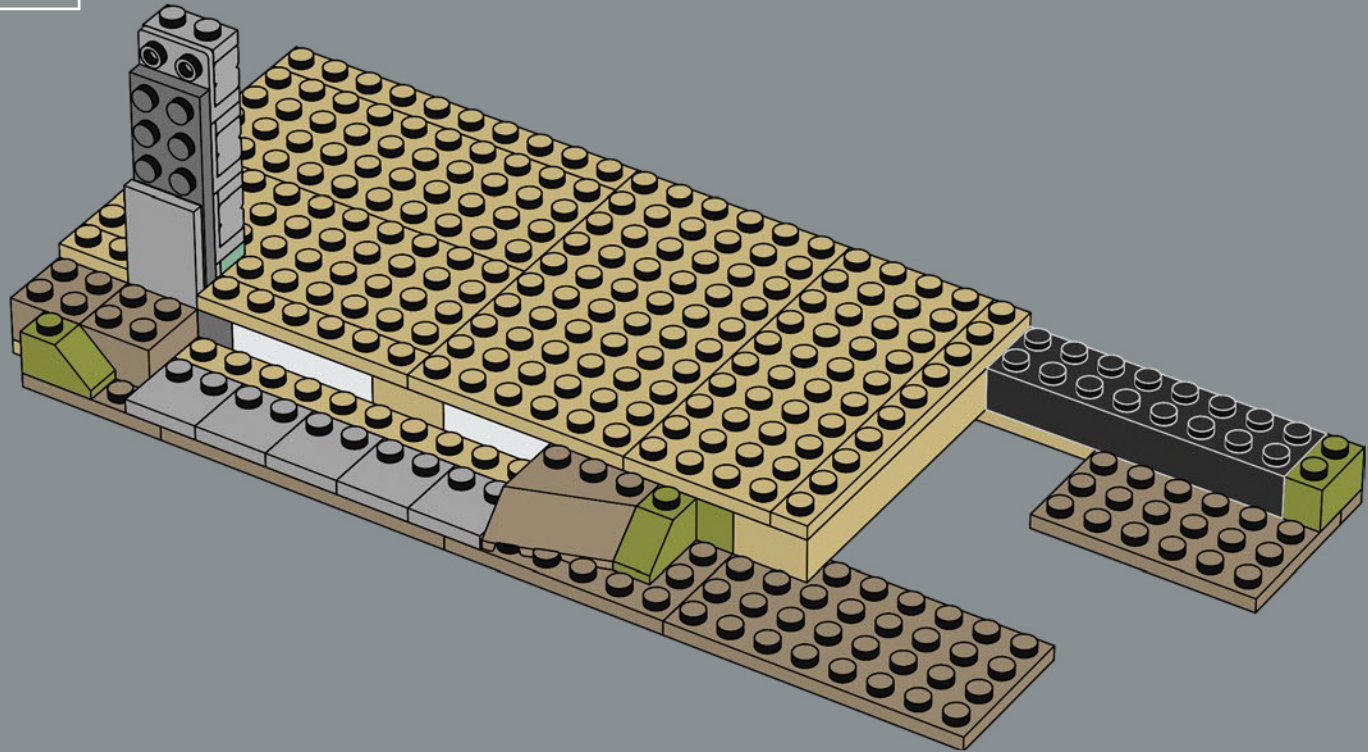

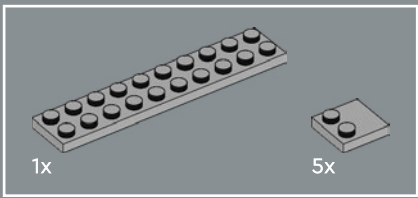

16

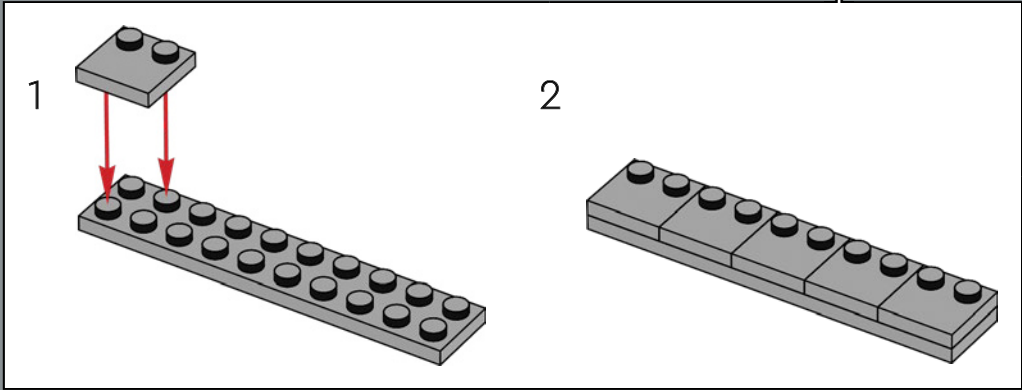
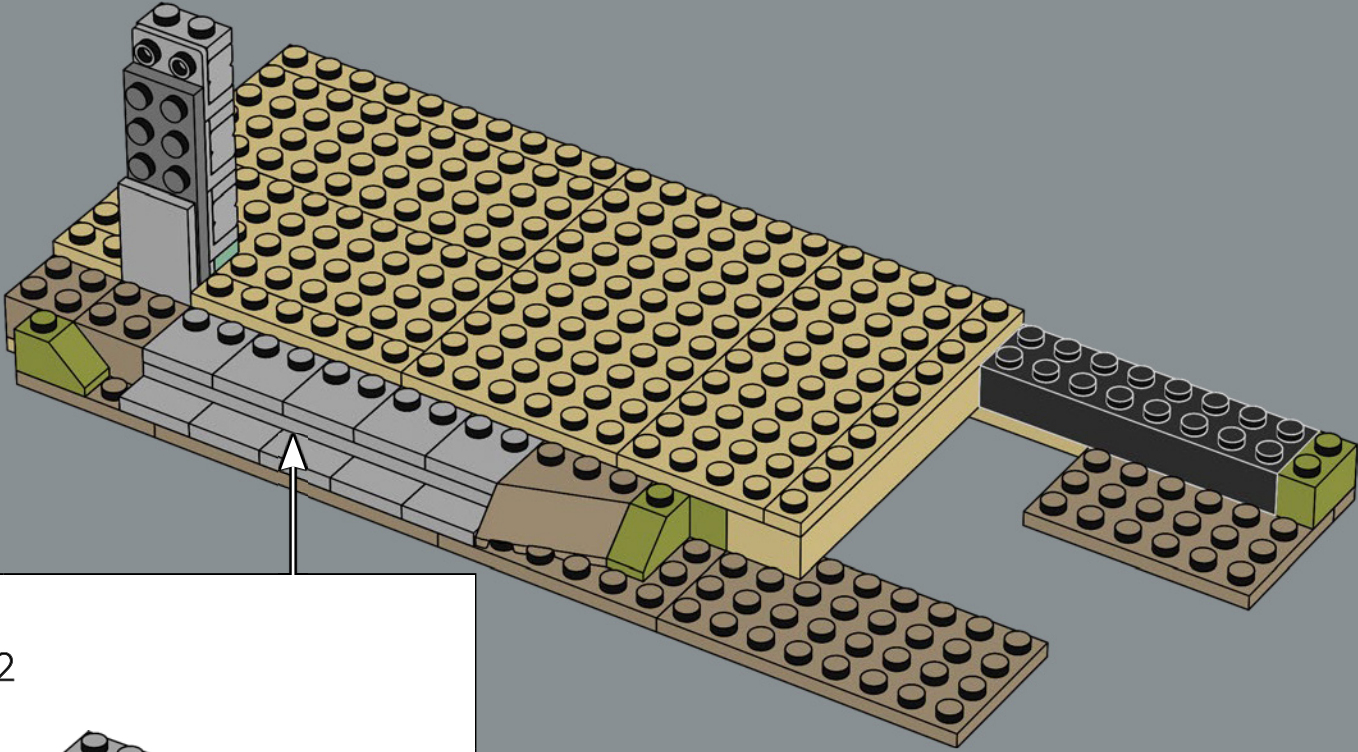



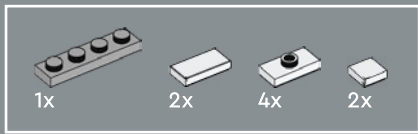

17

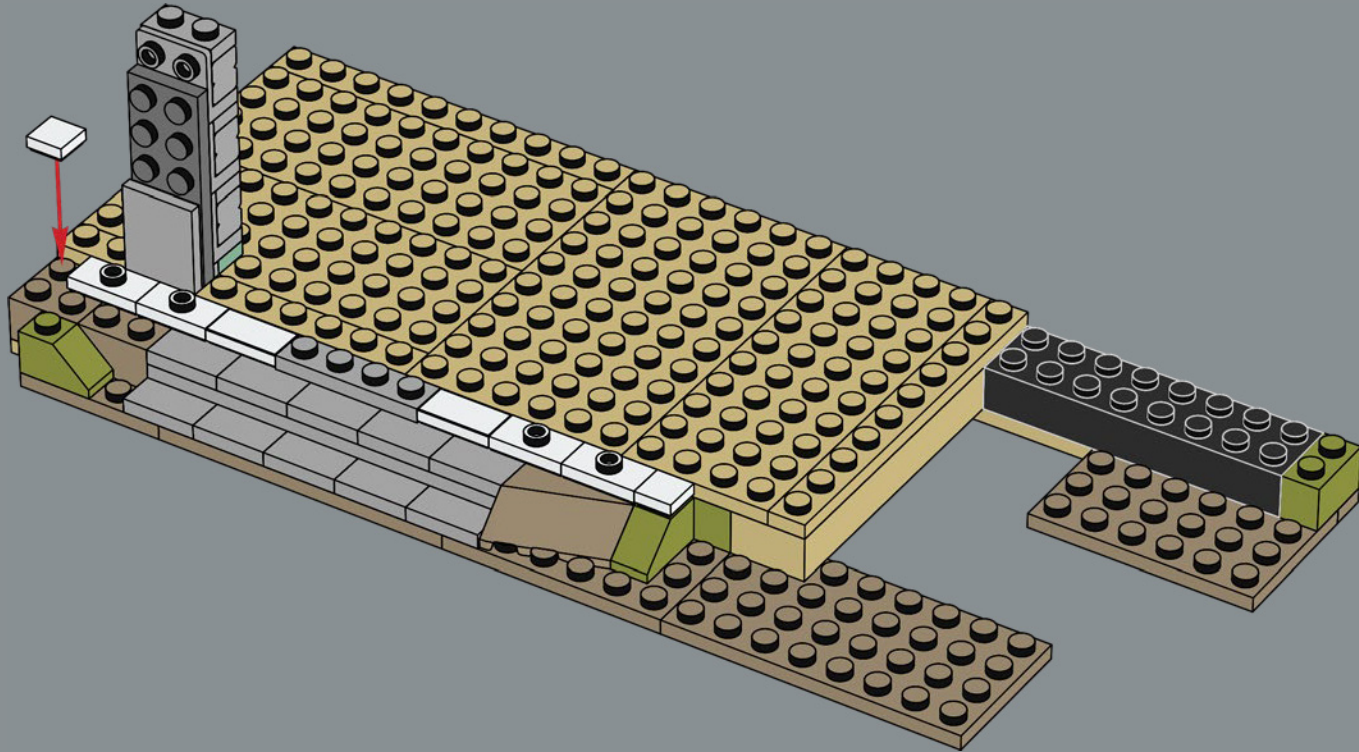

 1x	 2x
--	--

18

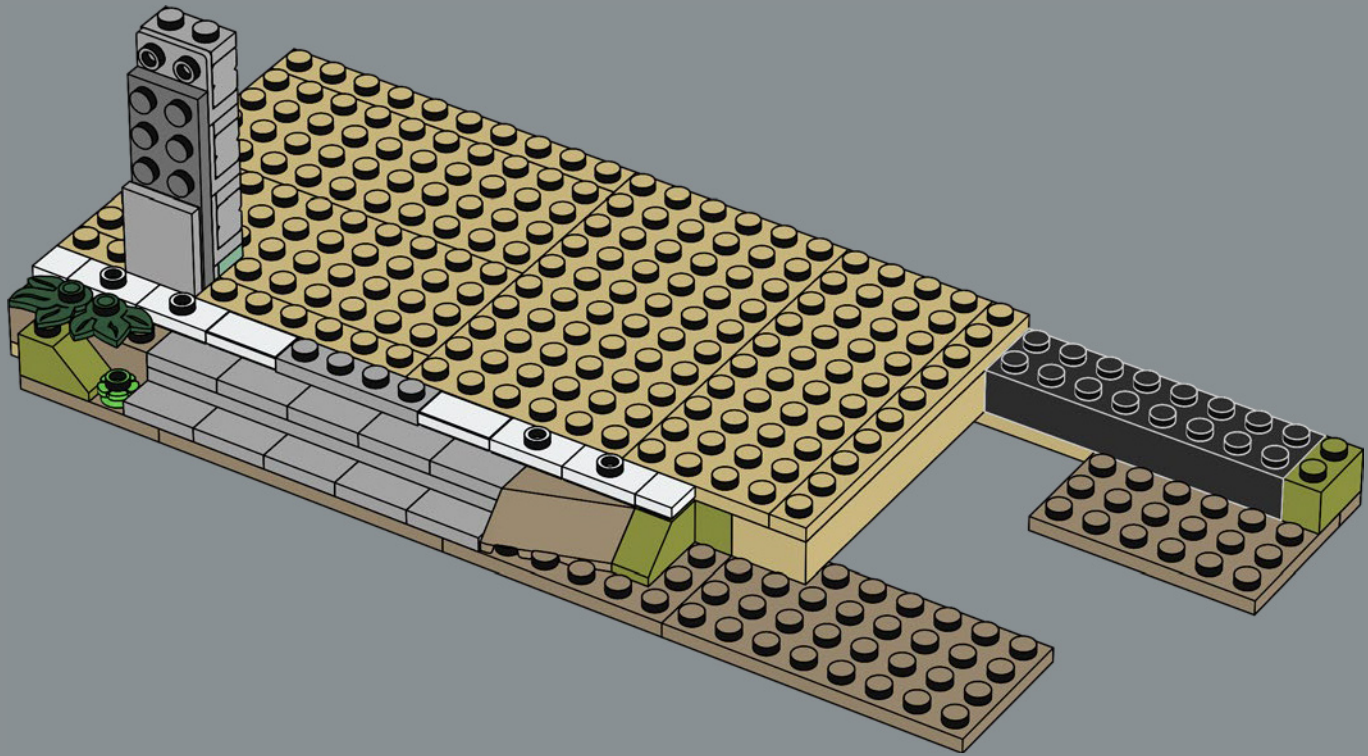

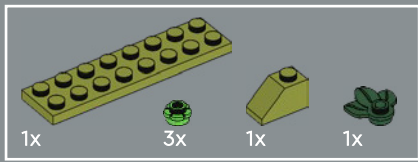

19

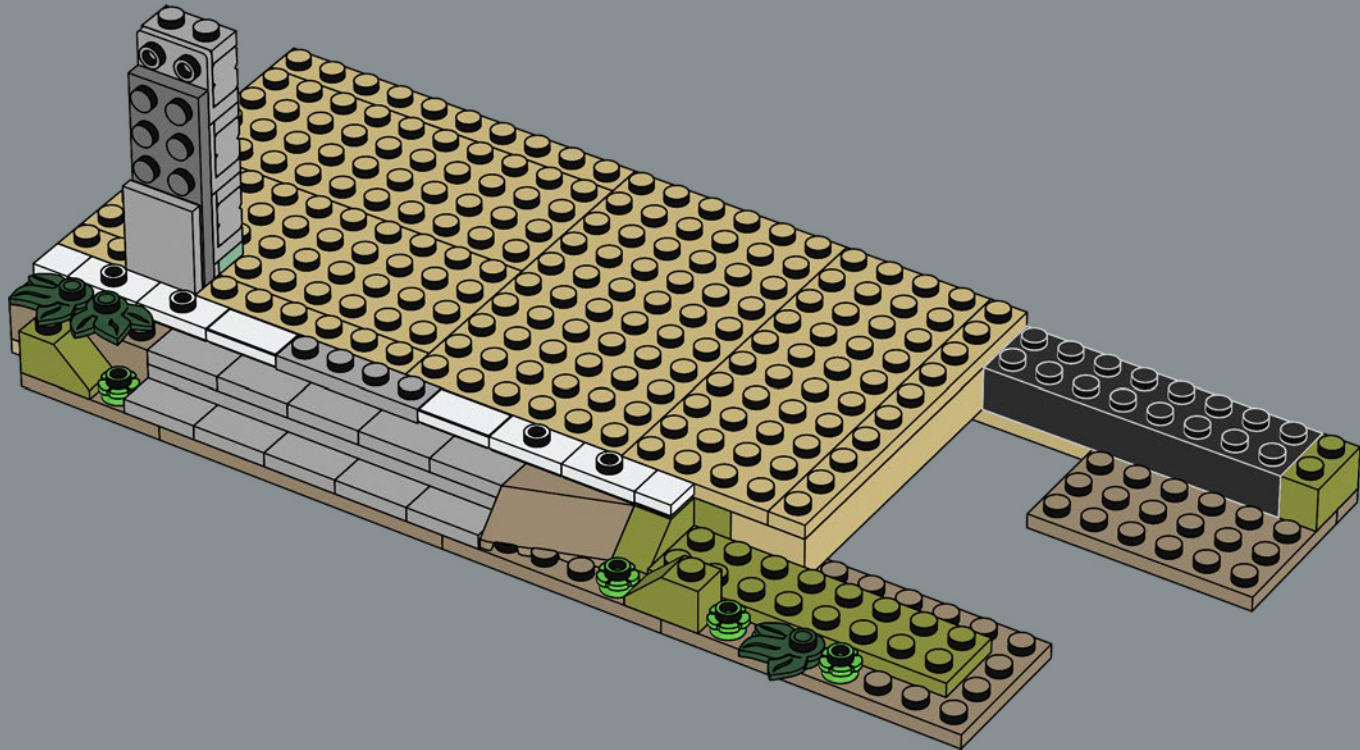

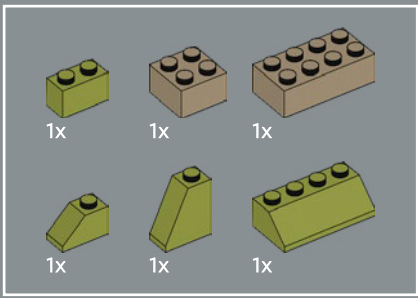

20

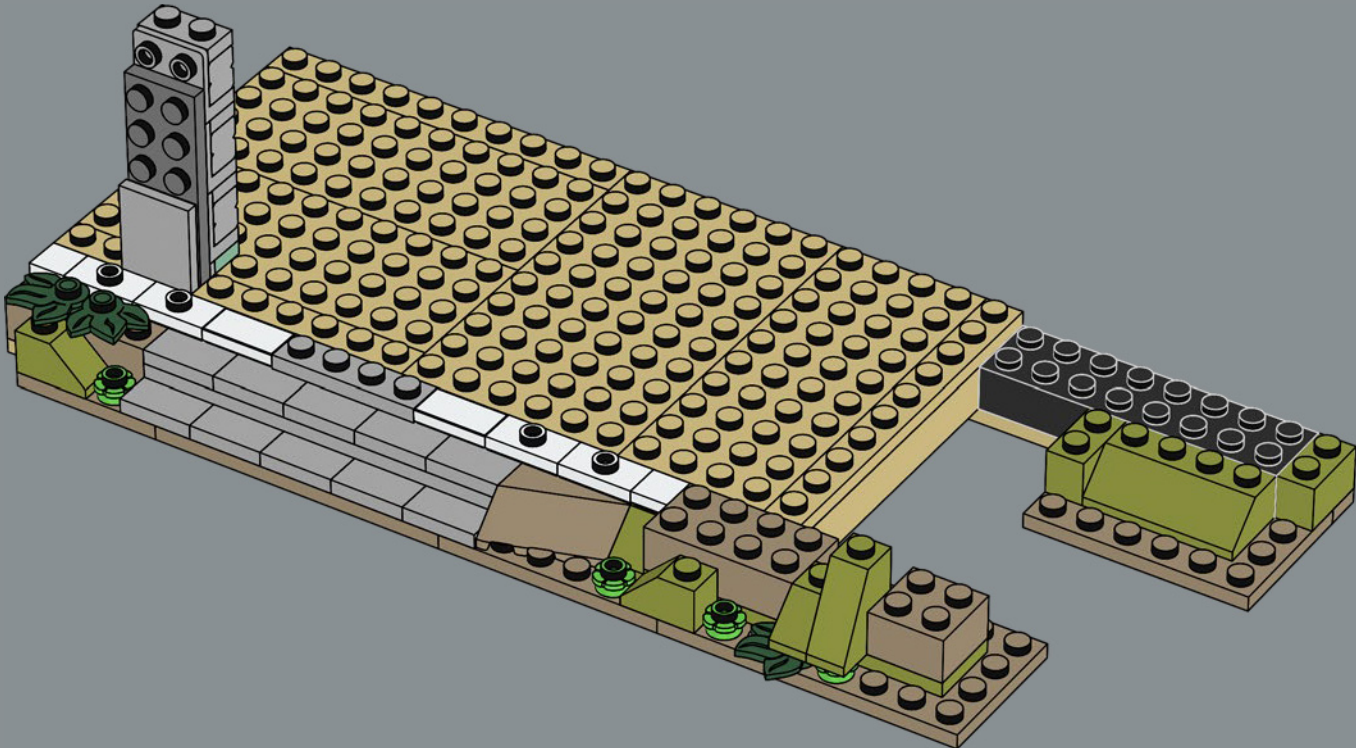

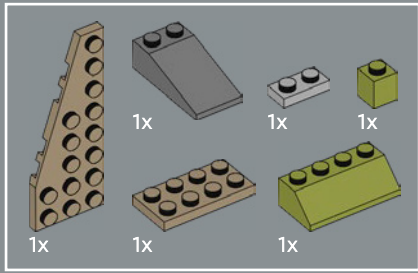

21

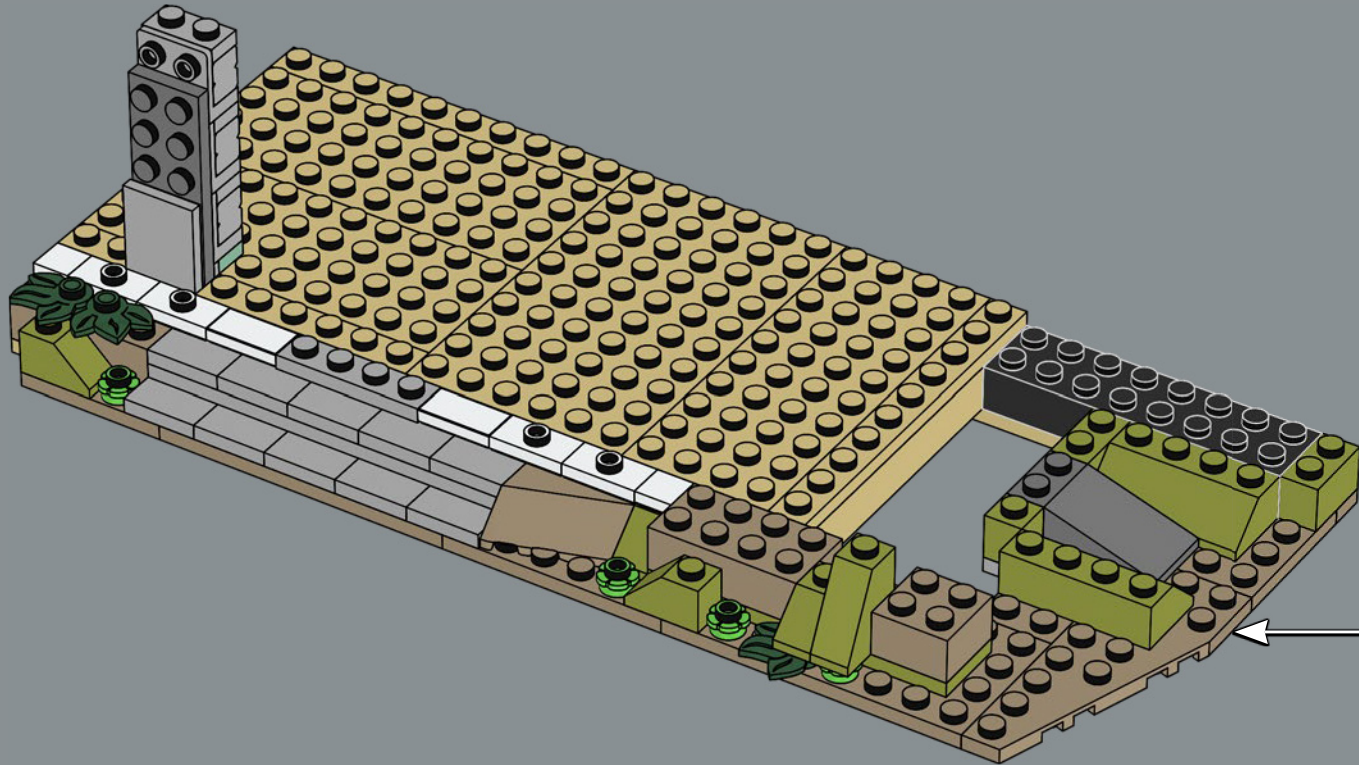
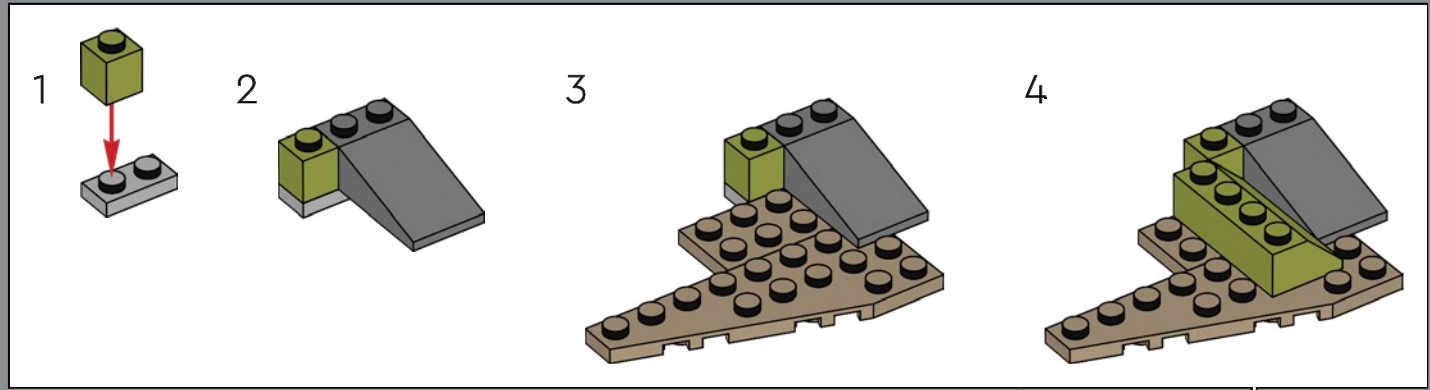

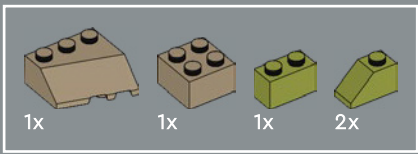

22

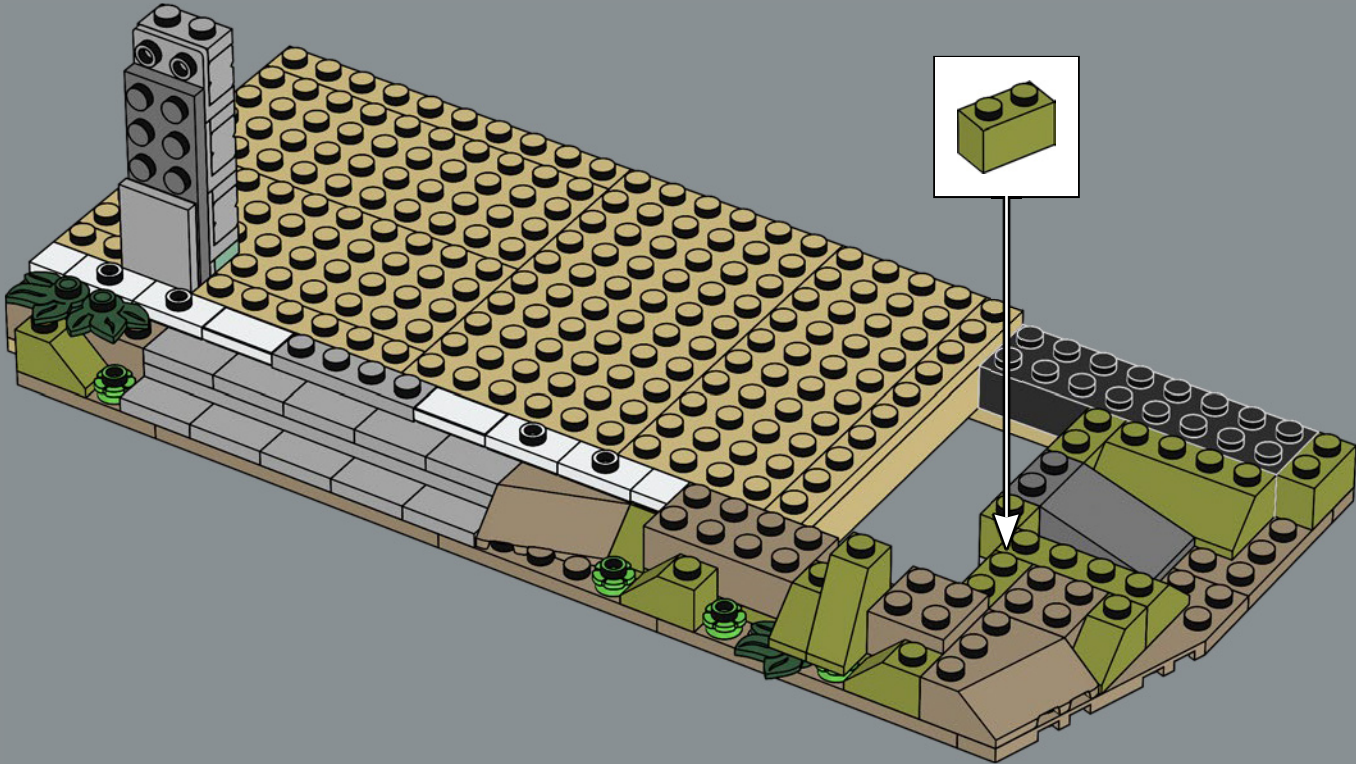

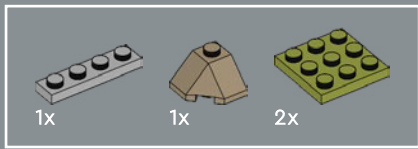

23

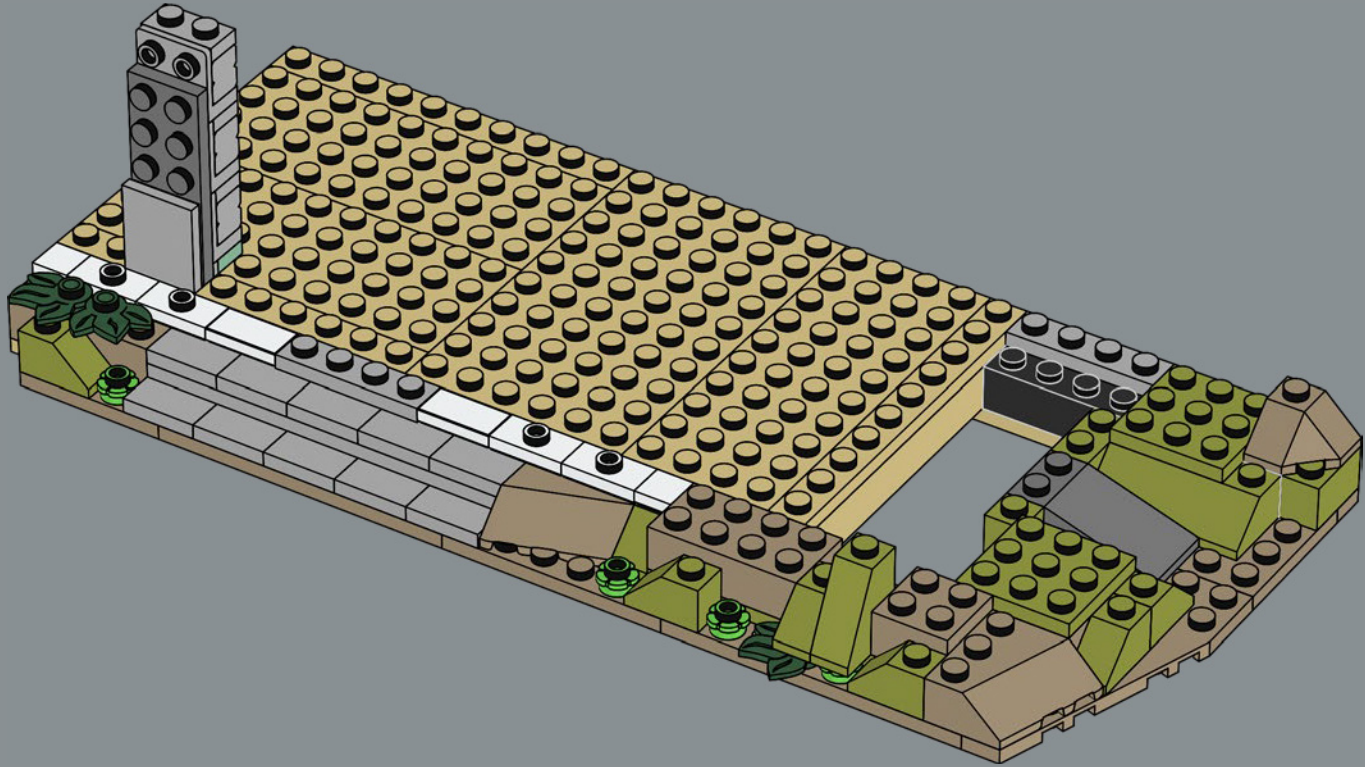

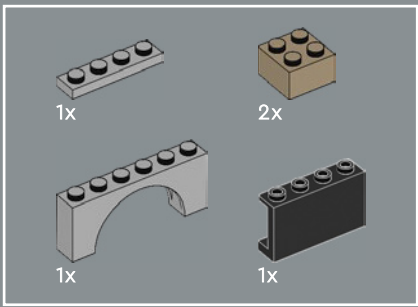

24

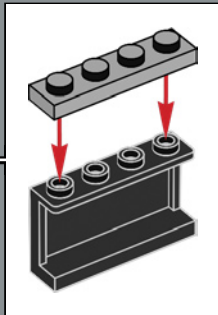
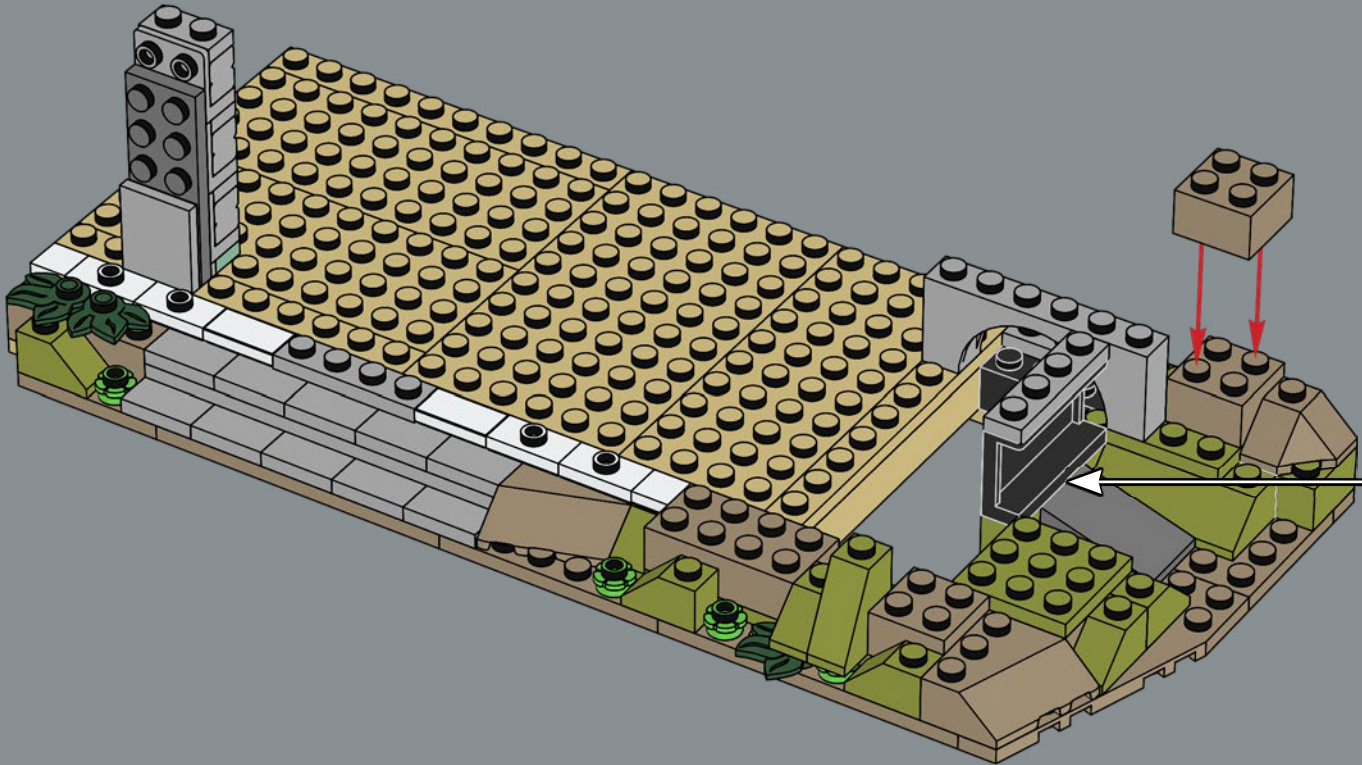



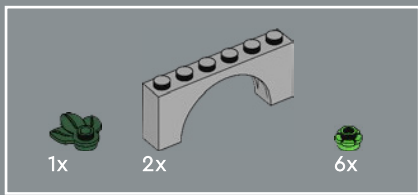

25

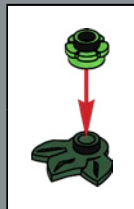
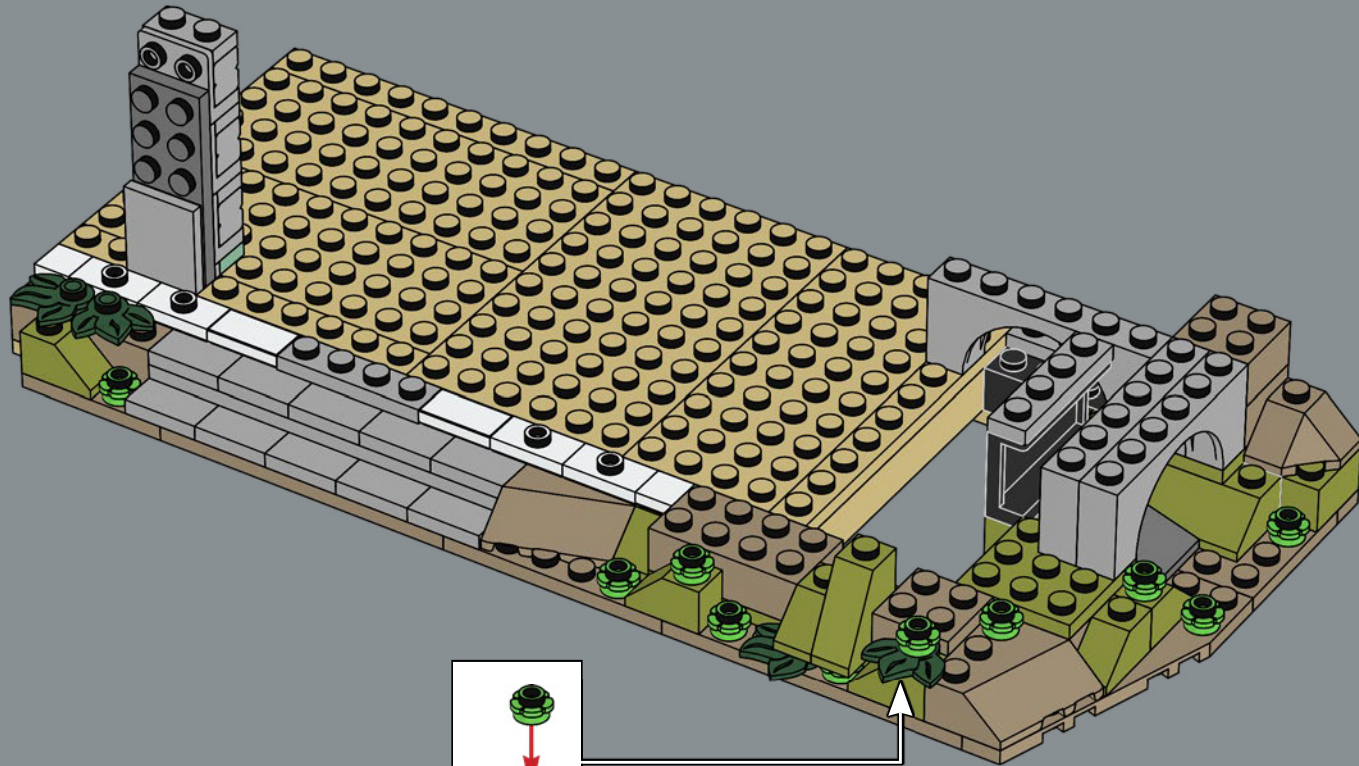

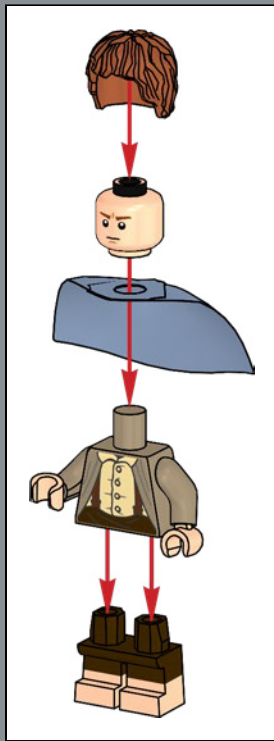
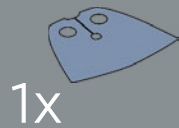

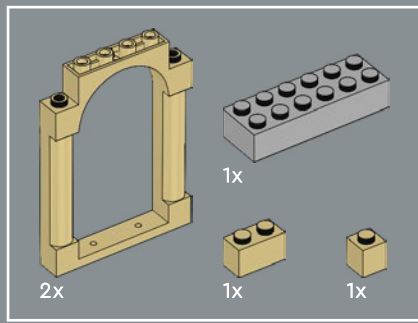

26

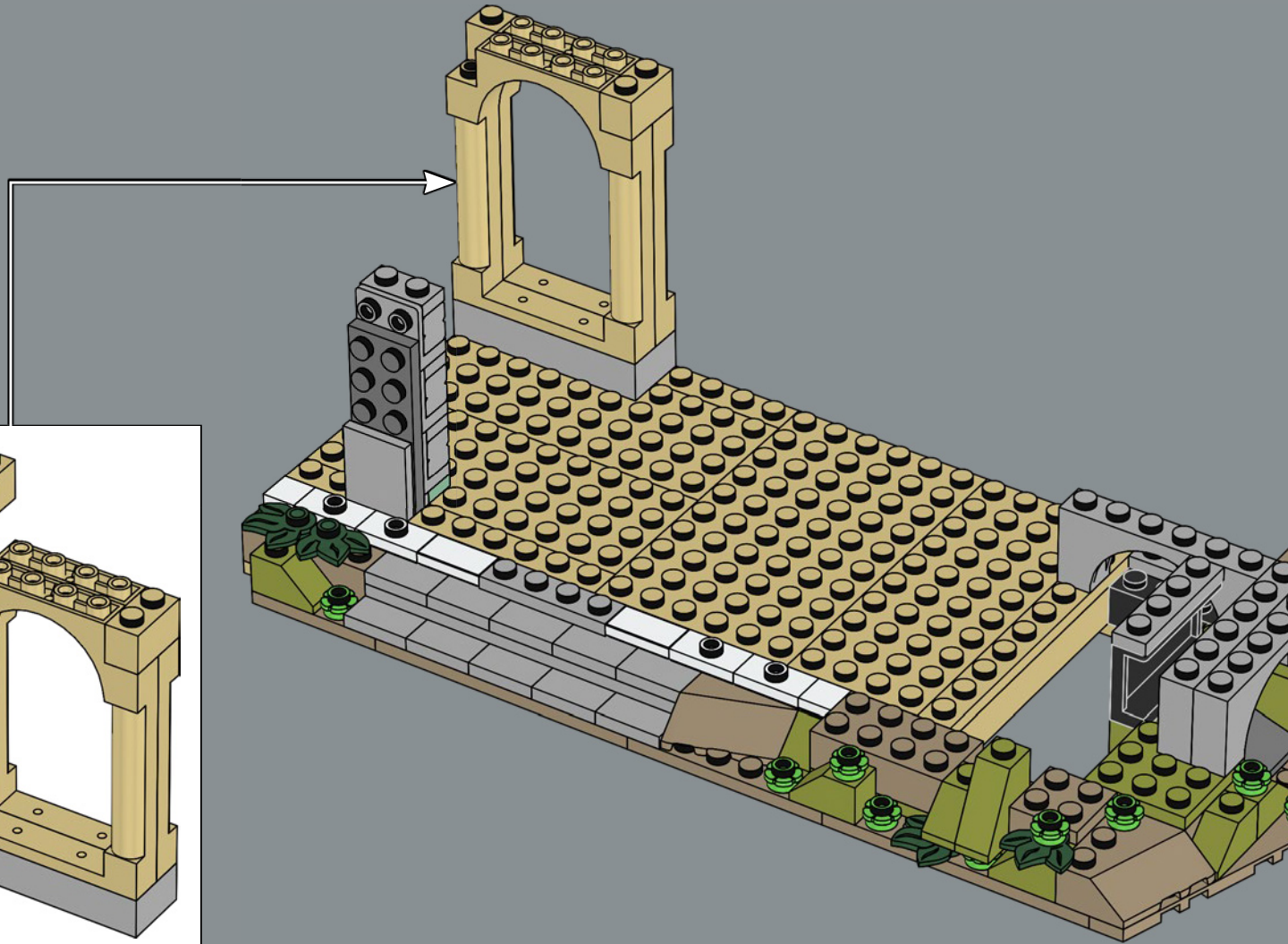
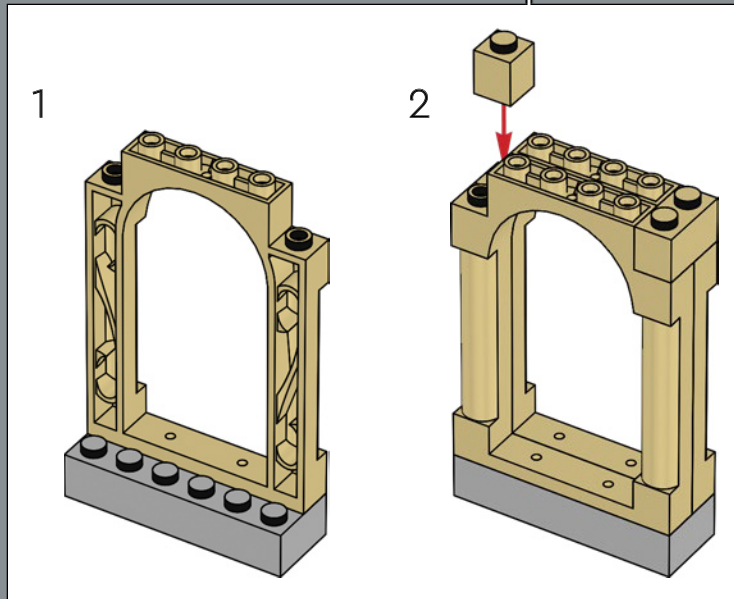

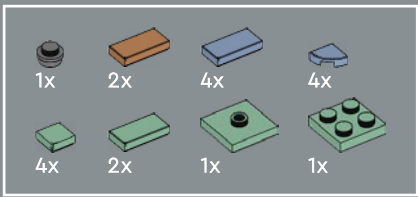

27

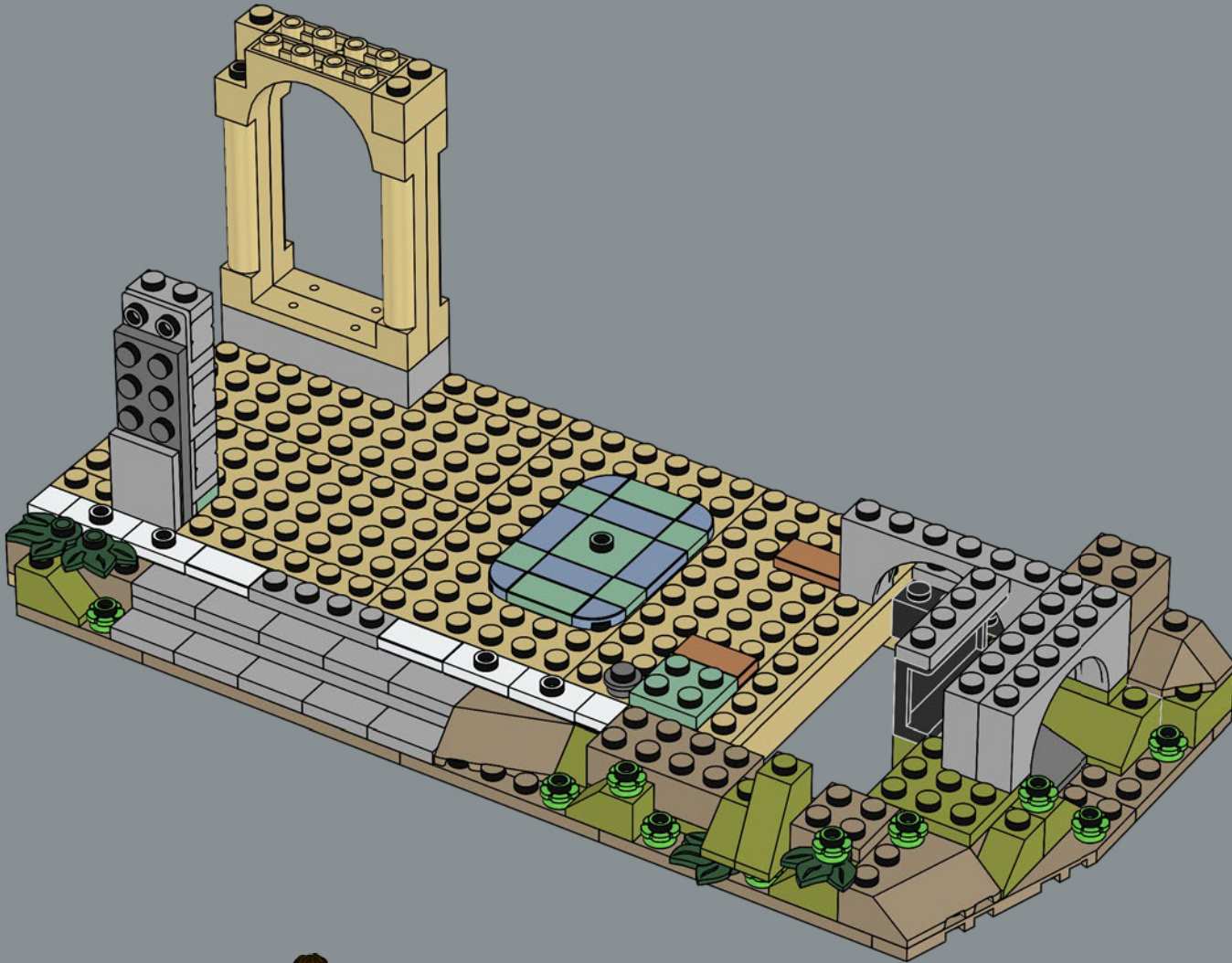

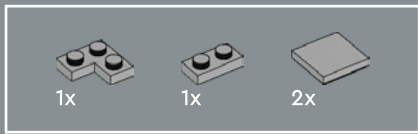

28

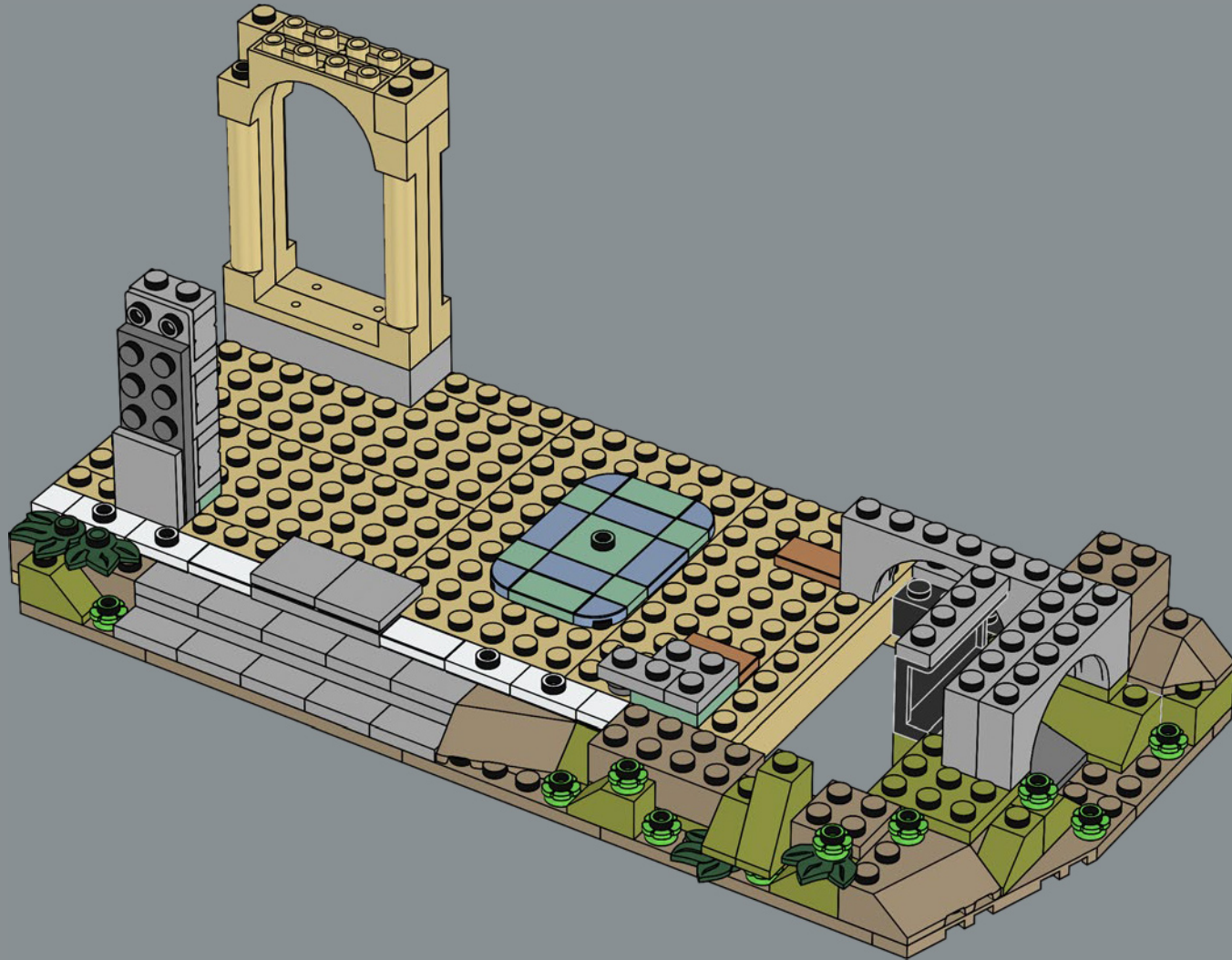



2x

29

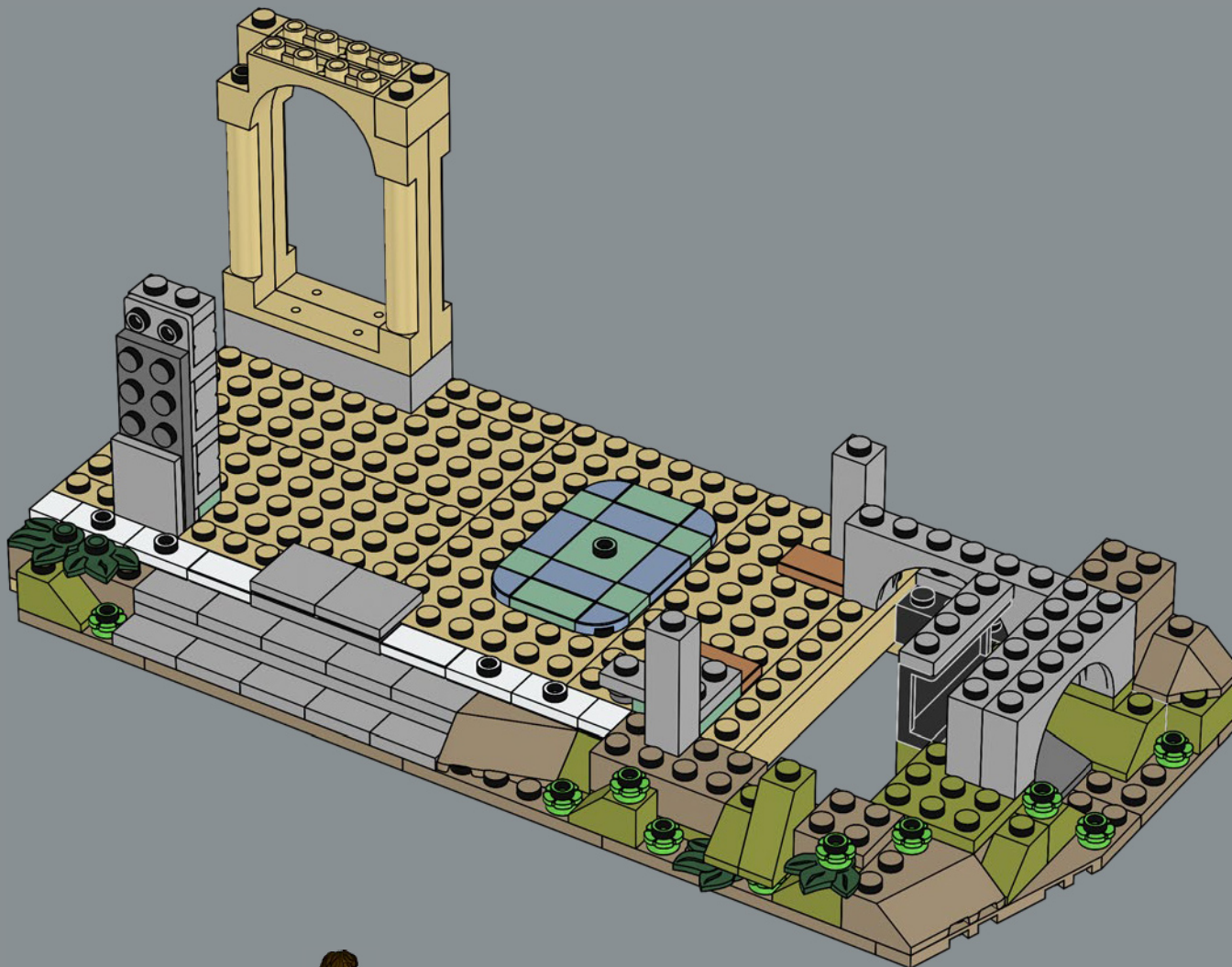



The fern element is a new design introduced in 2023. It's seen here for the first time, and there are 34 in this model!

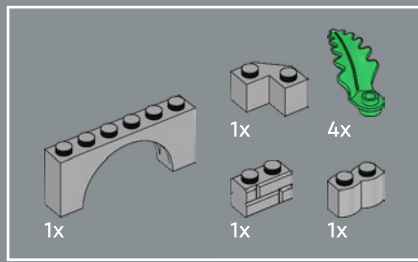

30

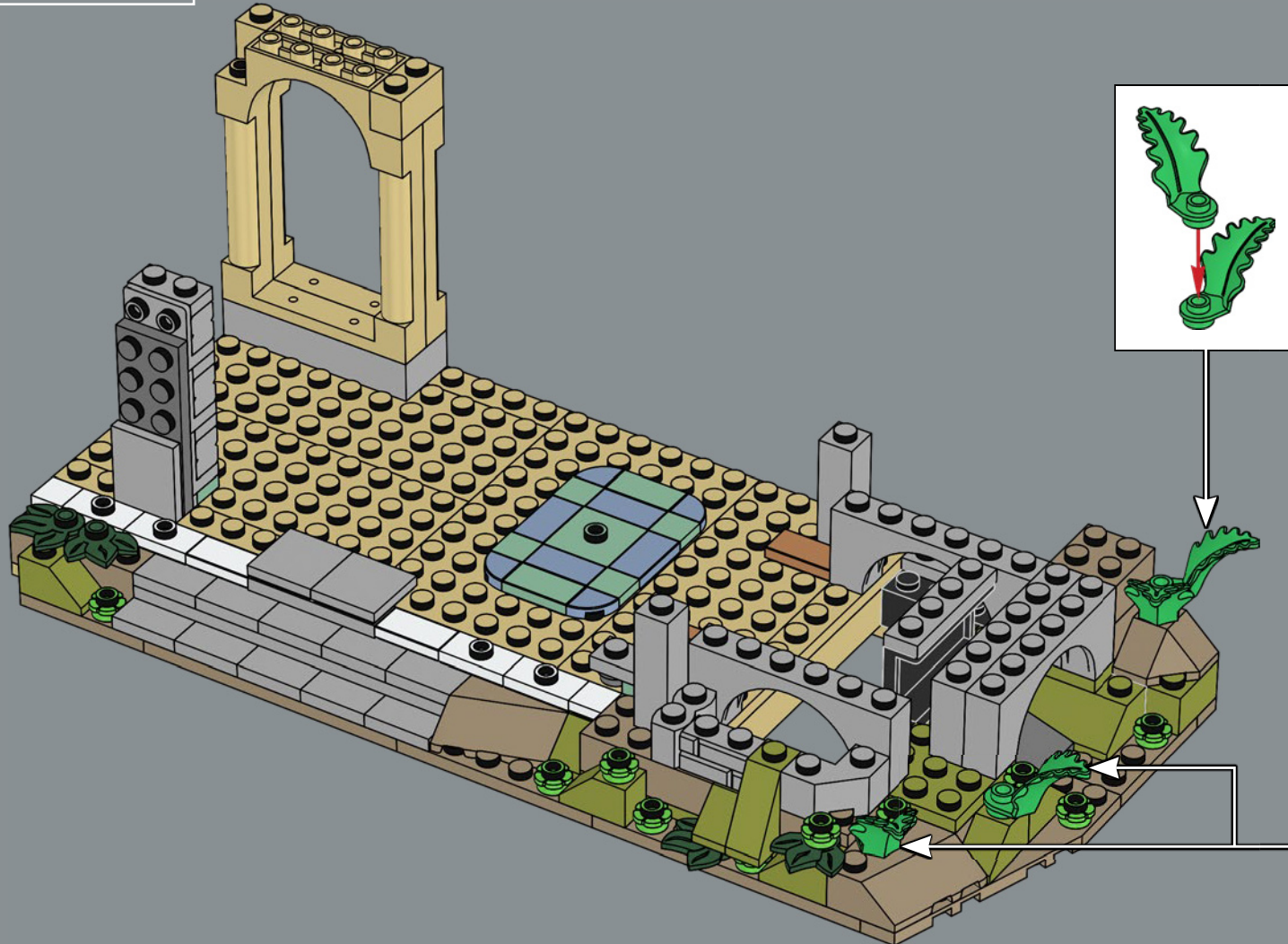

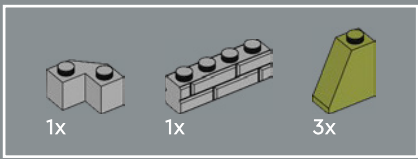

31

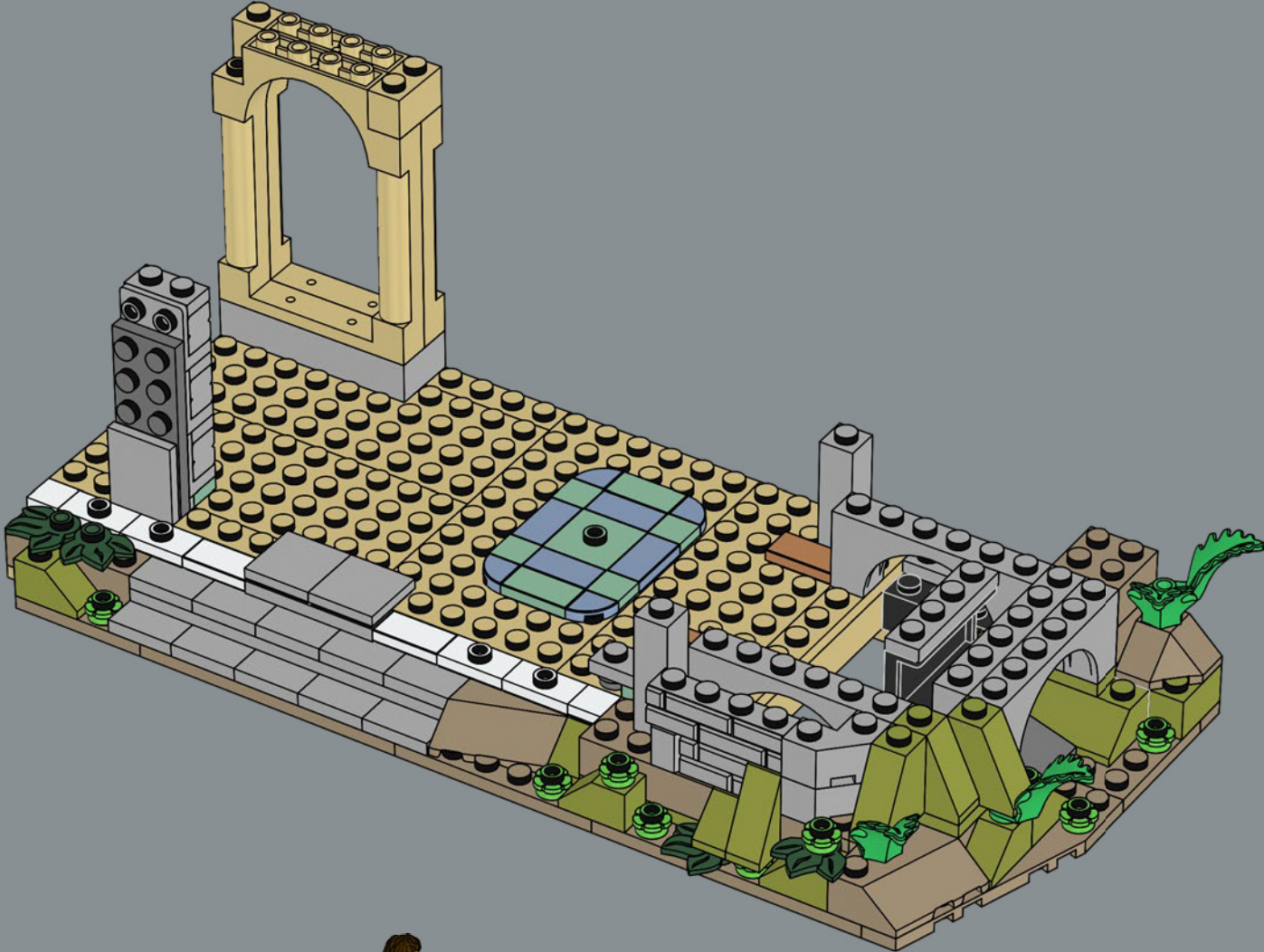



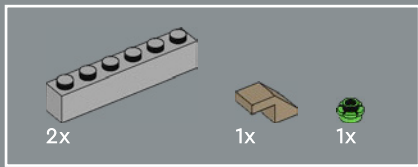

32

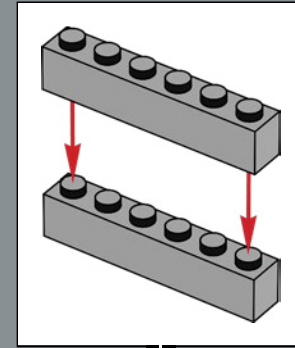
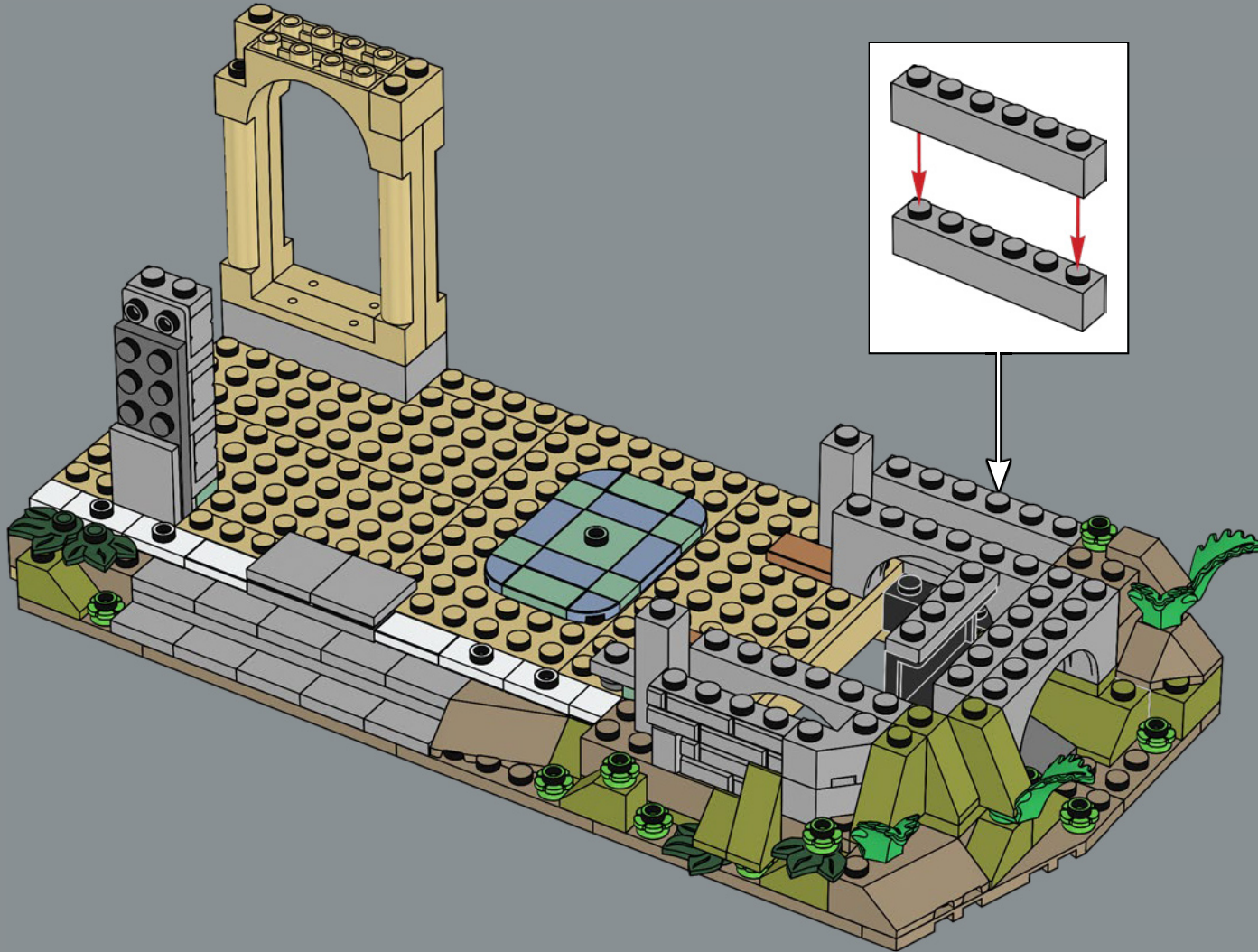

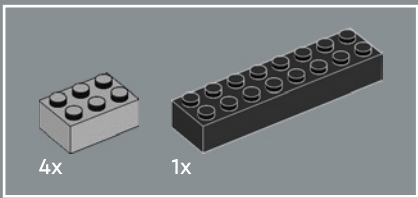

33

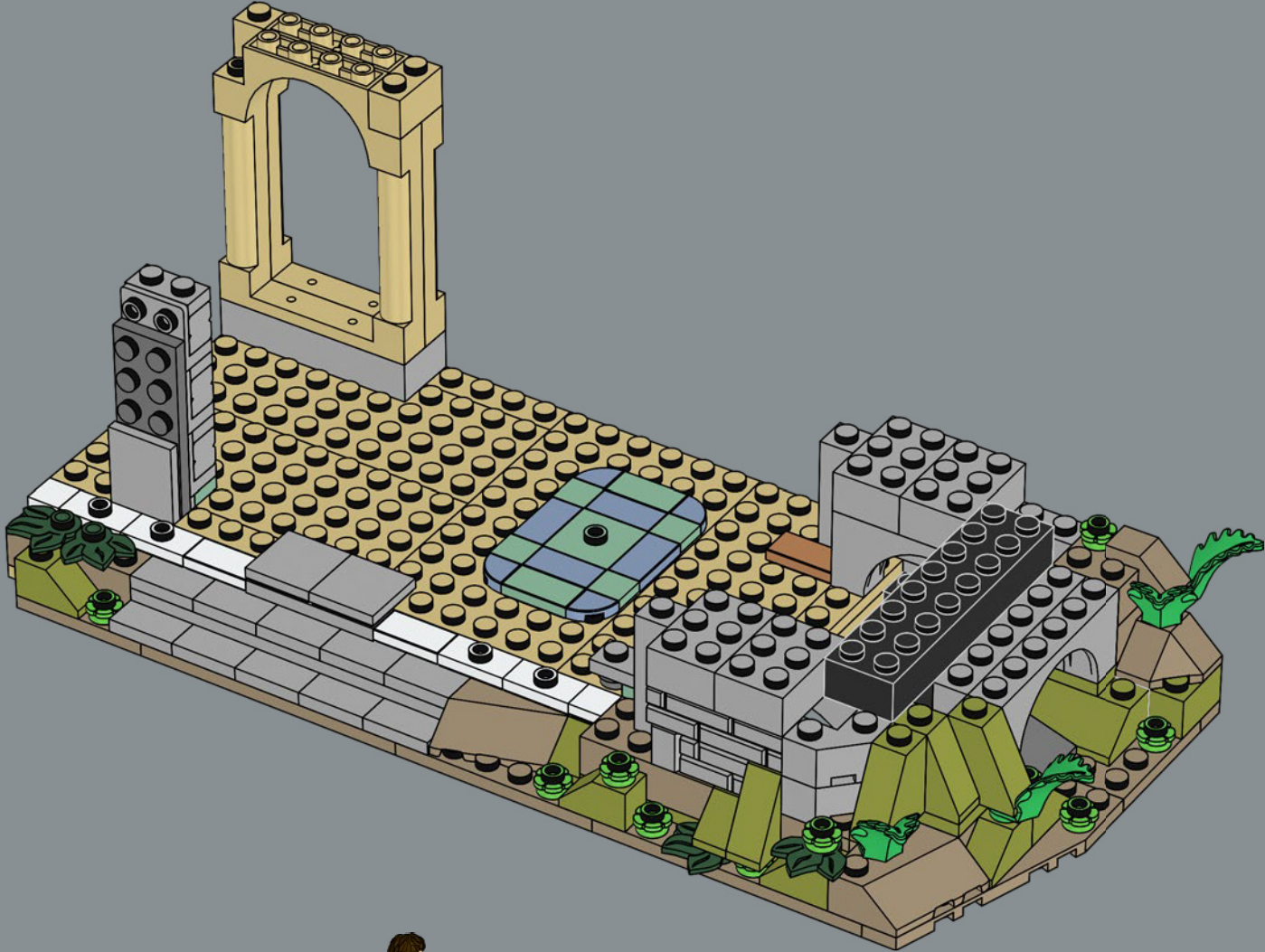

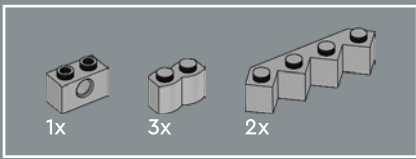

34

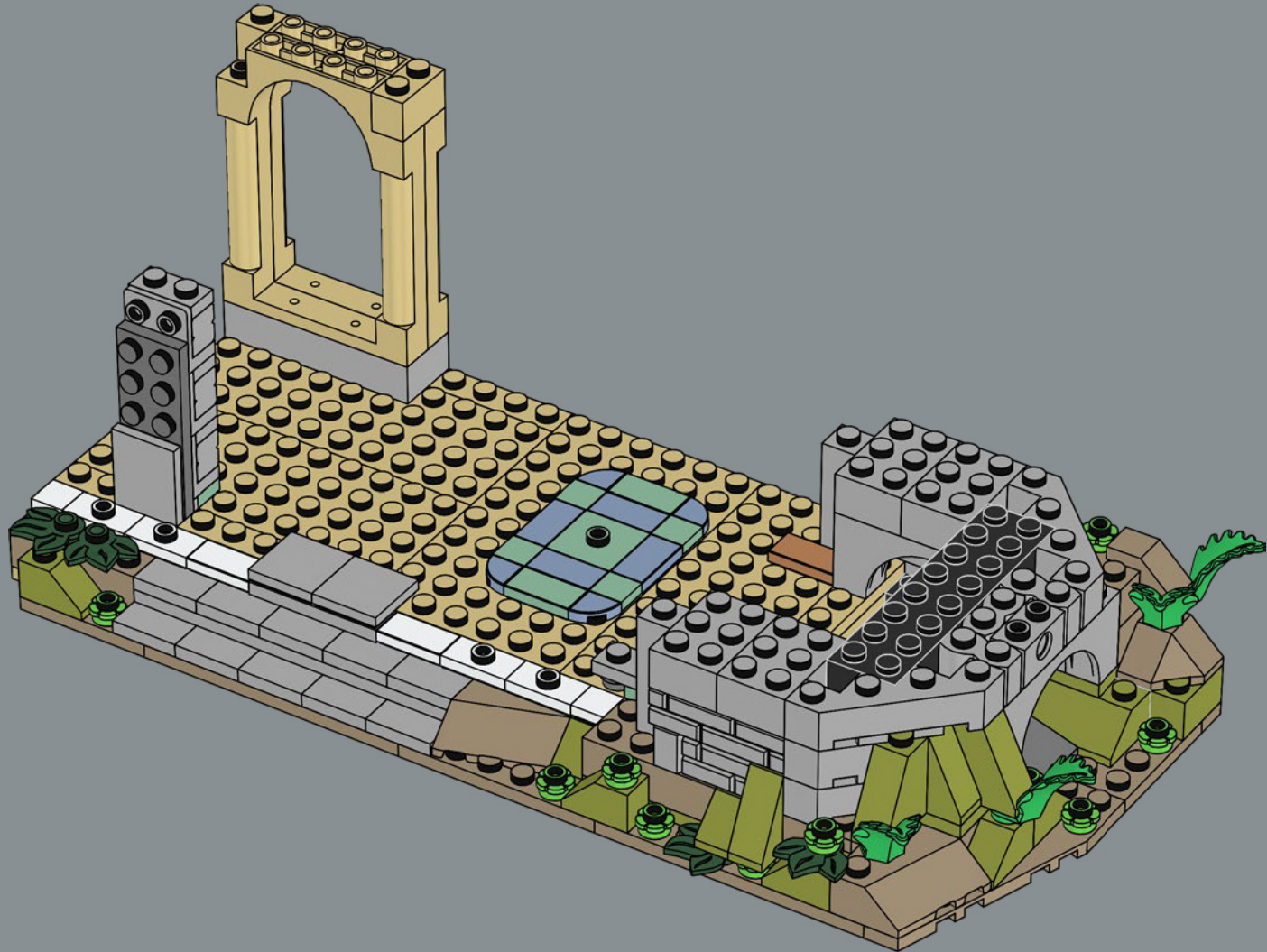

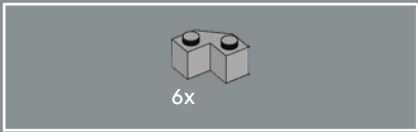

35

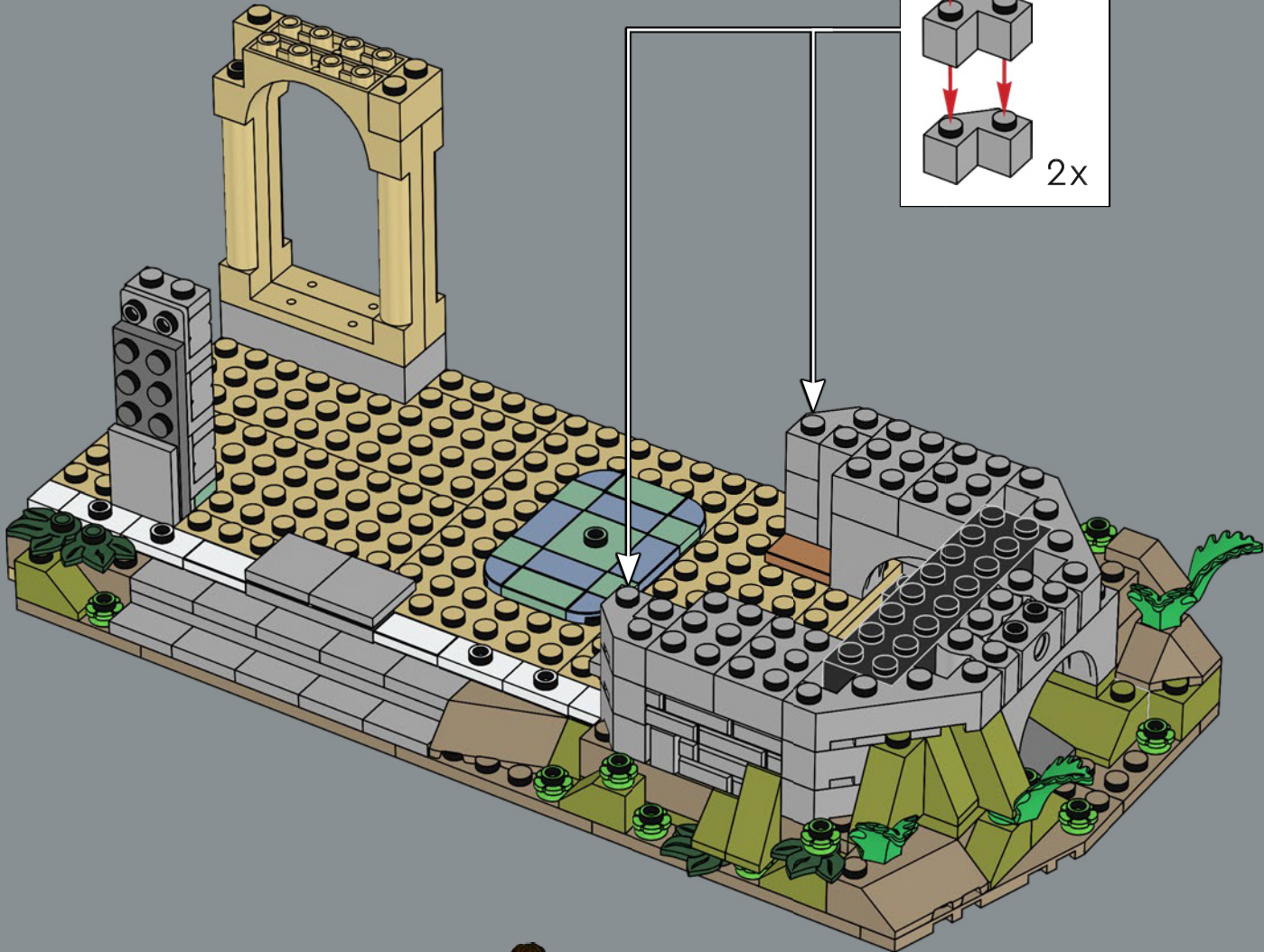
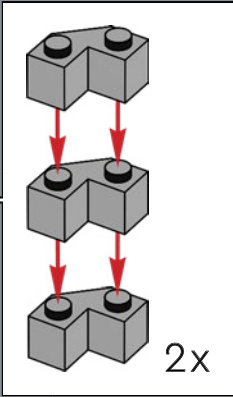

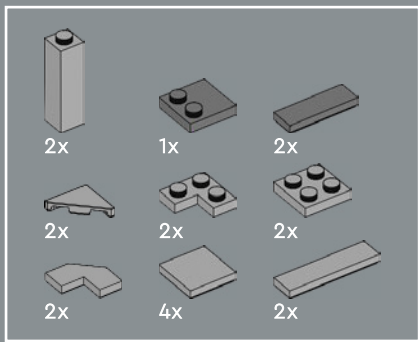

36

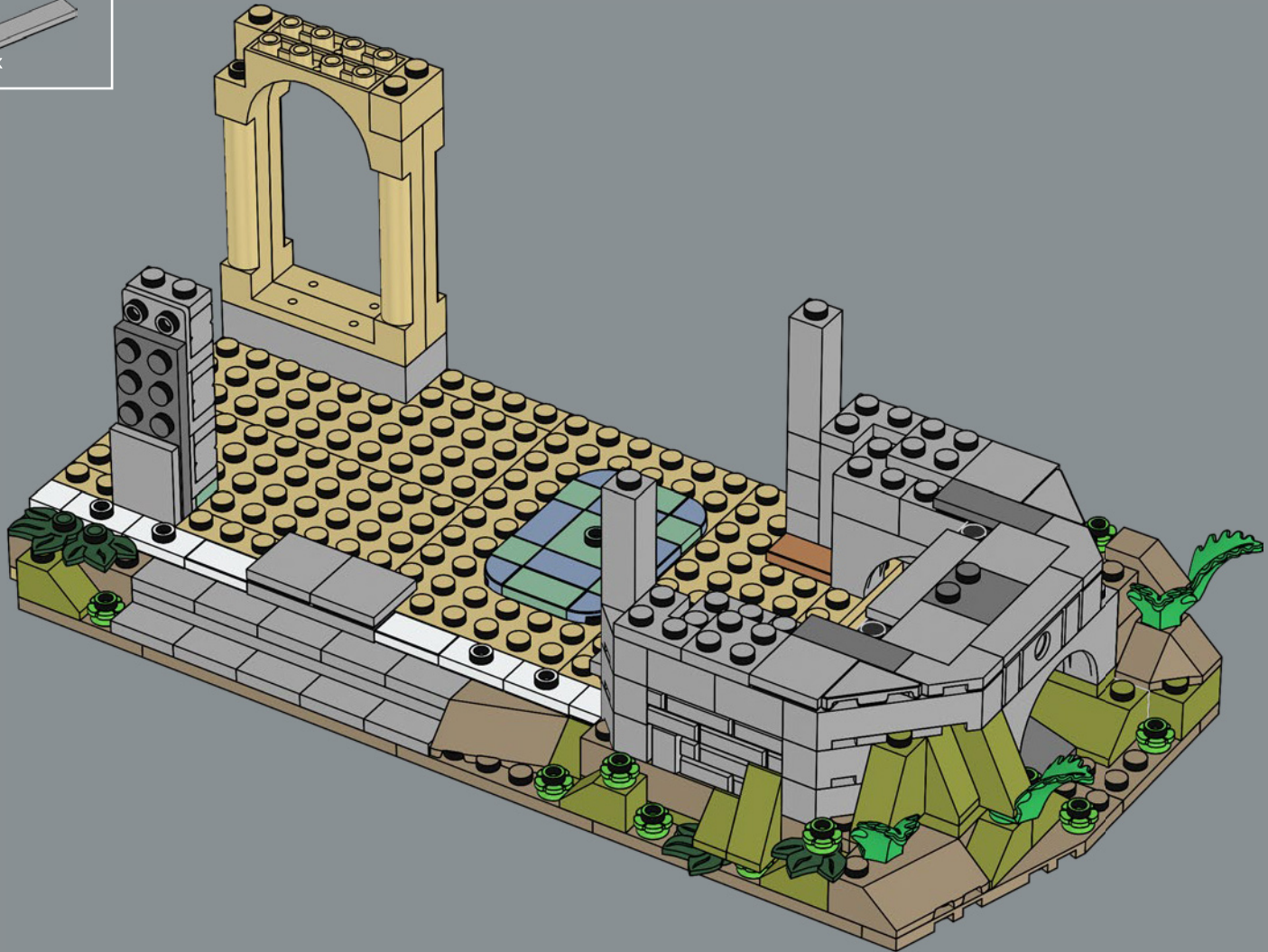

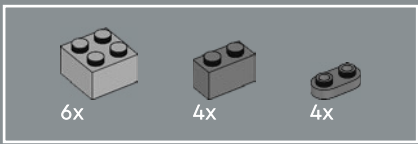

37

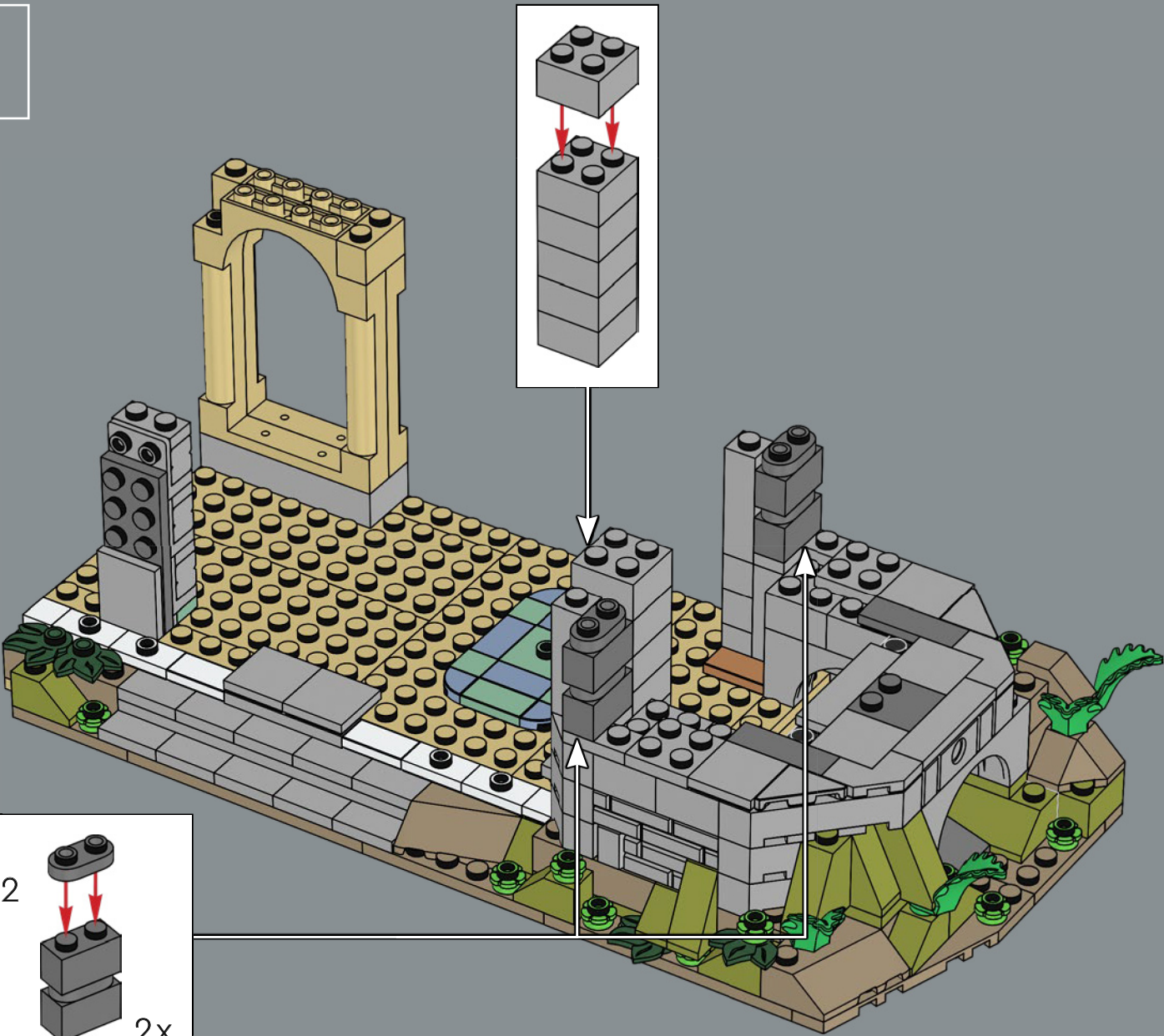

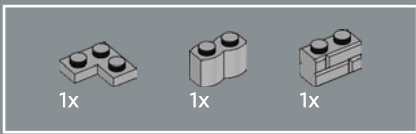

38

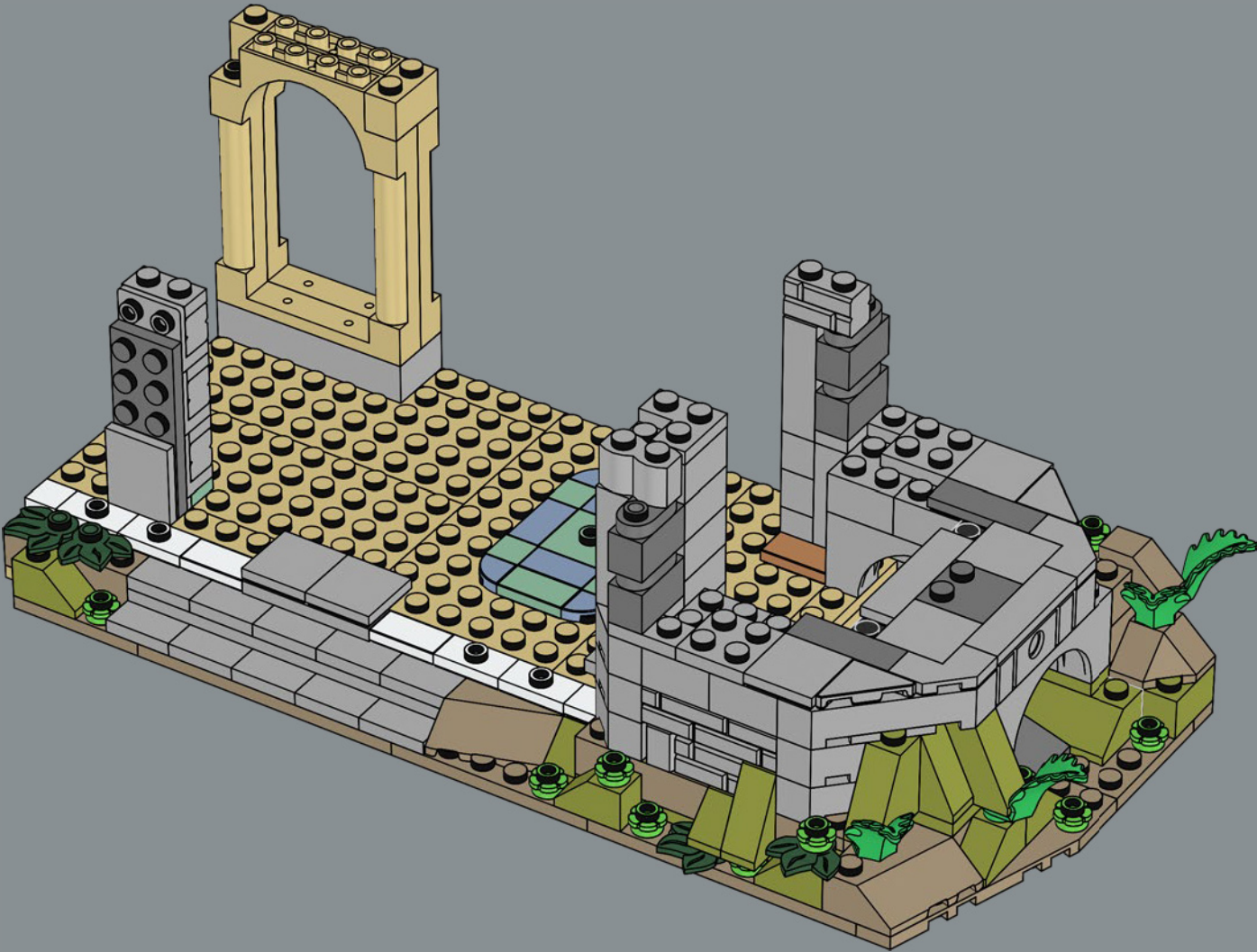



This hidey-hole for Samwise Gamgee was one of the final features added to the model.

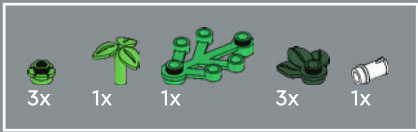

39

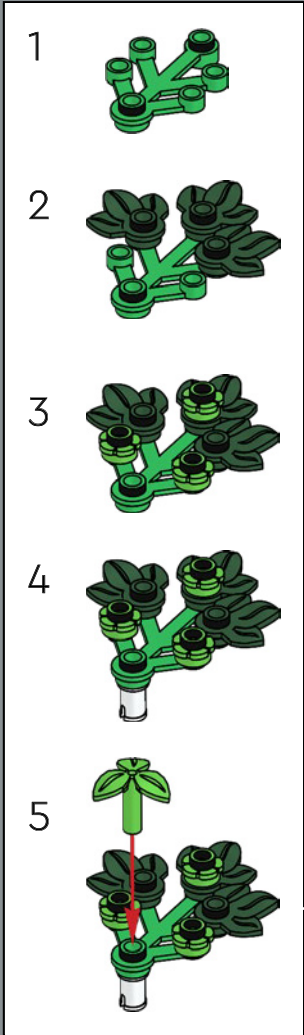



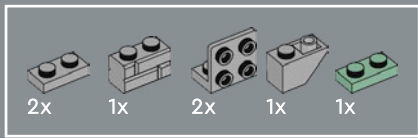

40

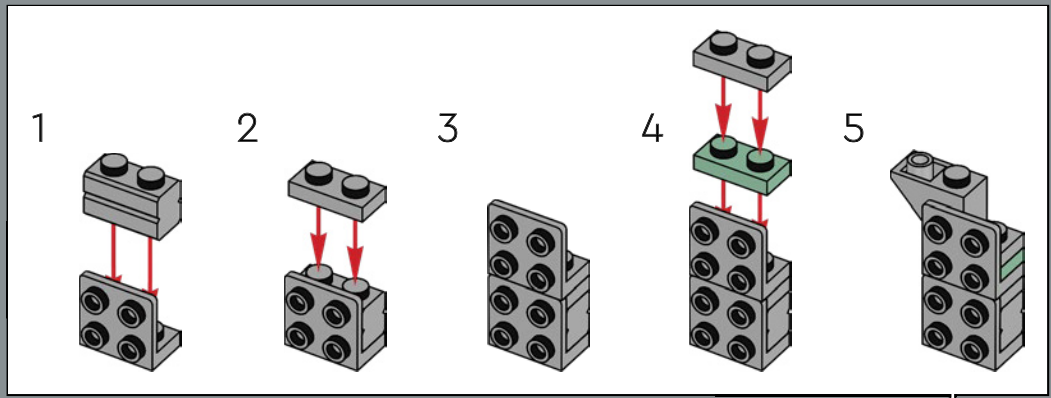
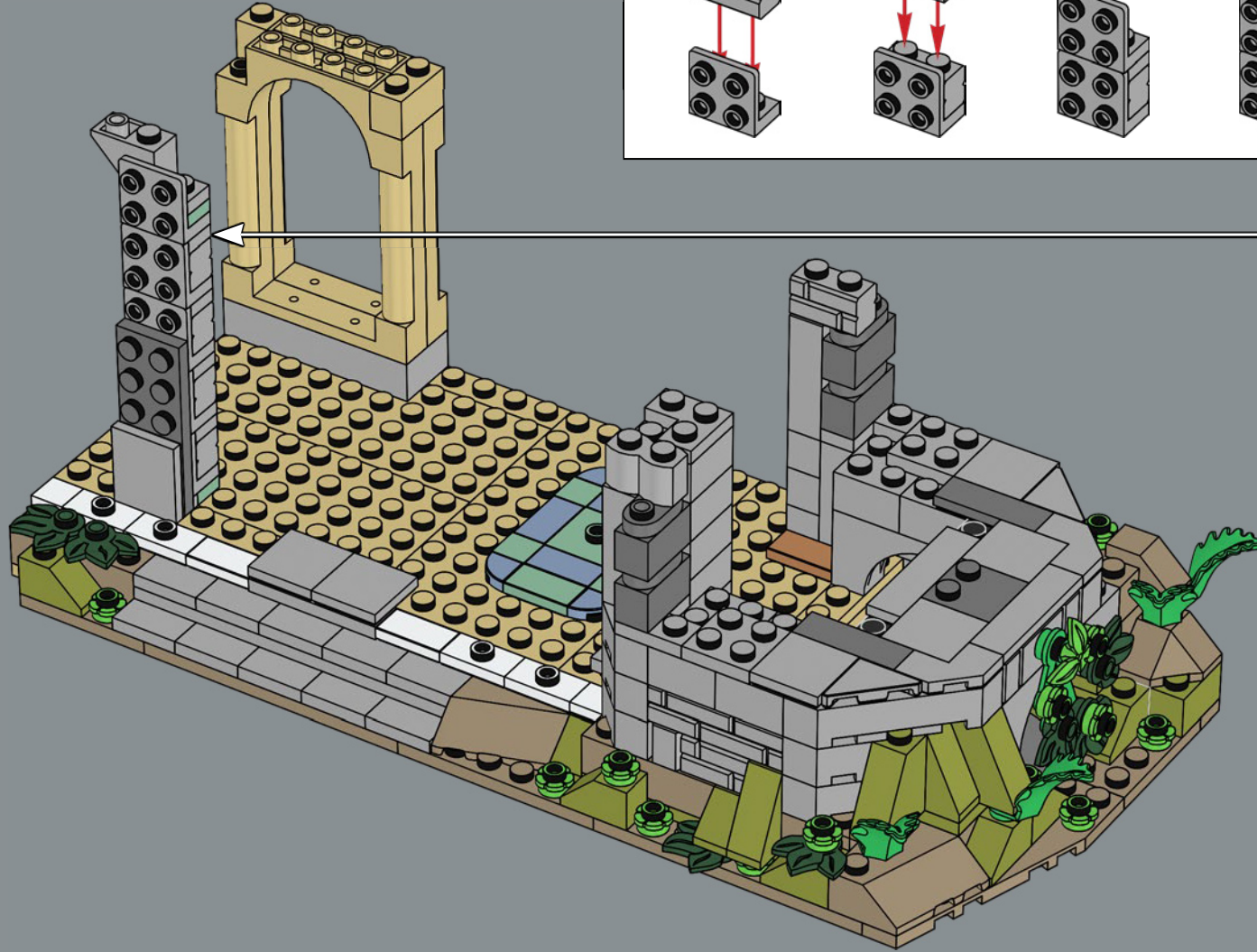

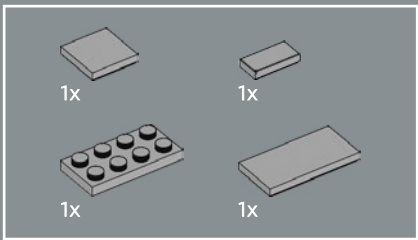

41

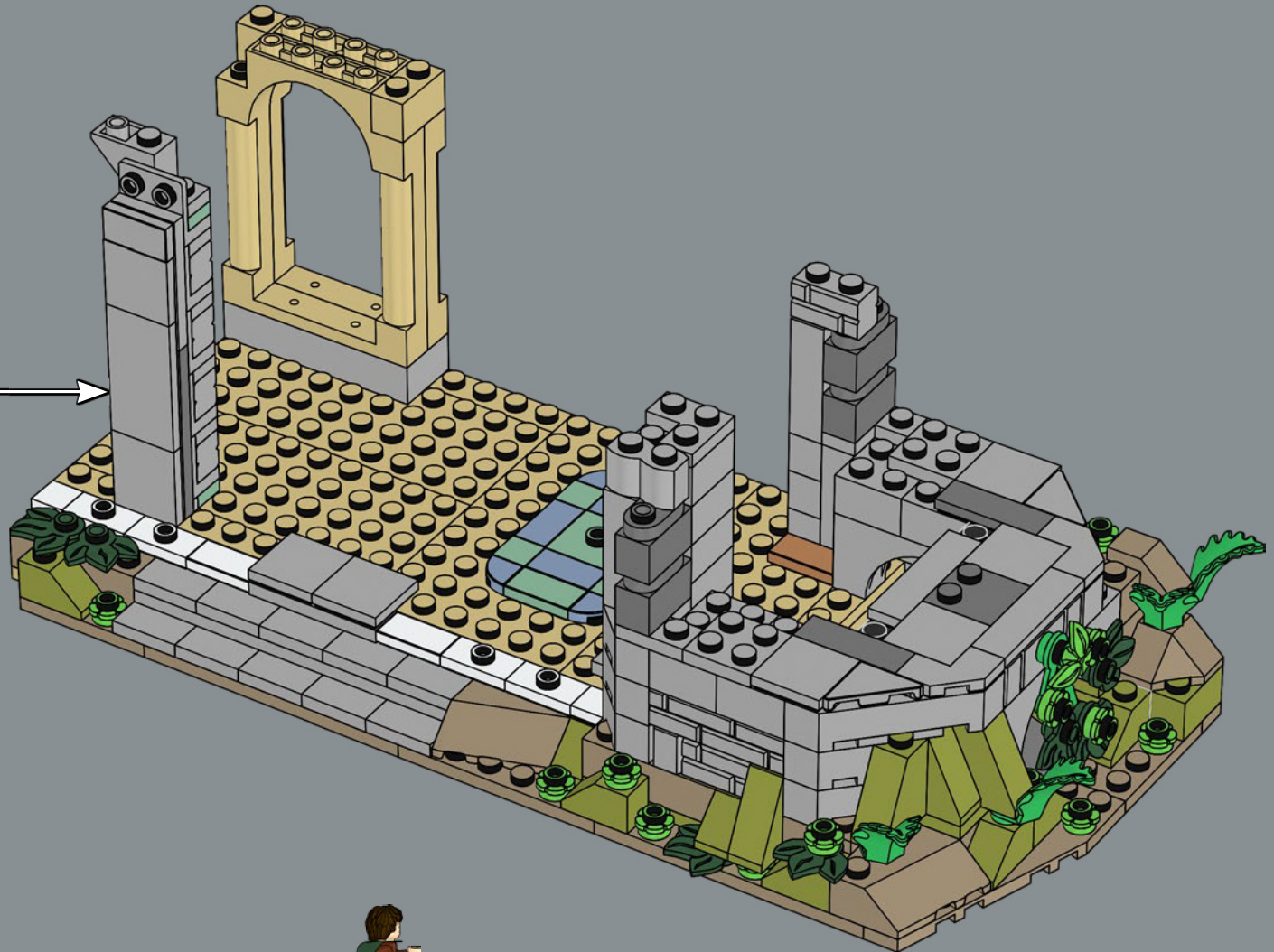
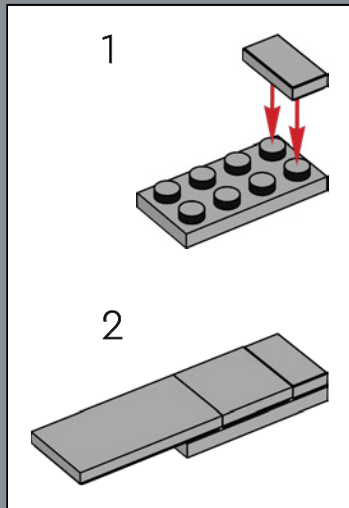

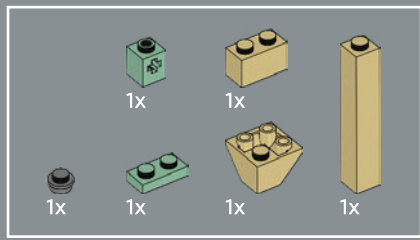

42

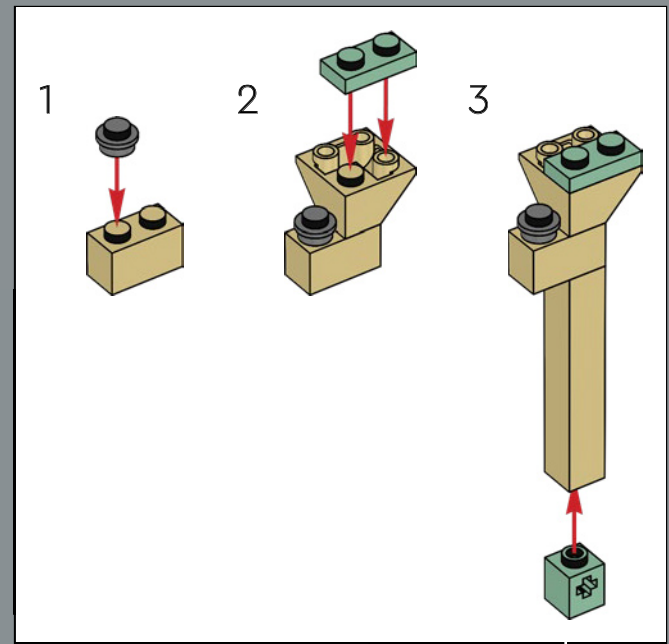
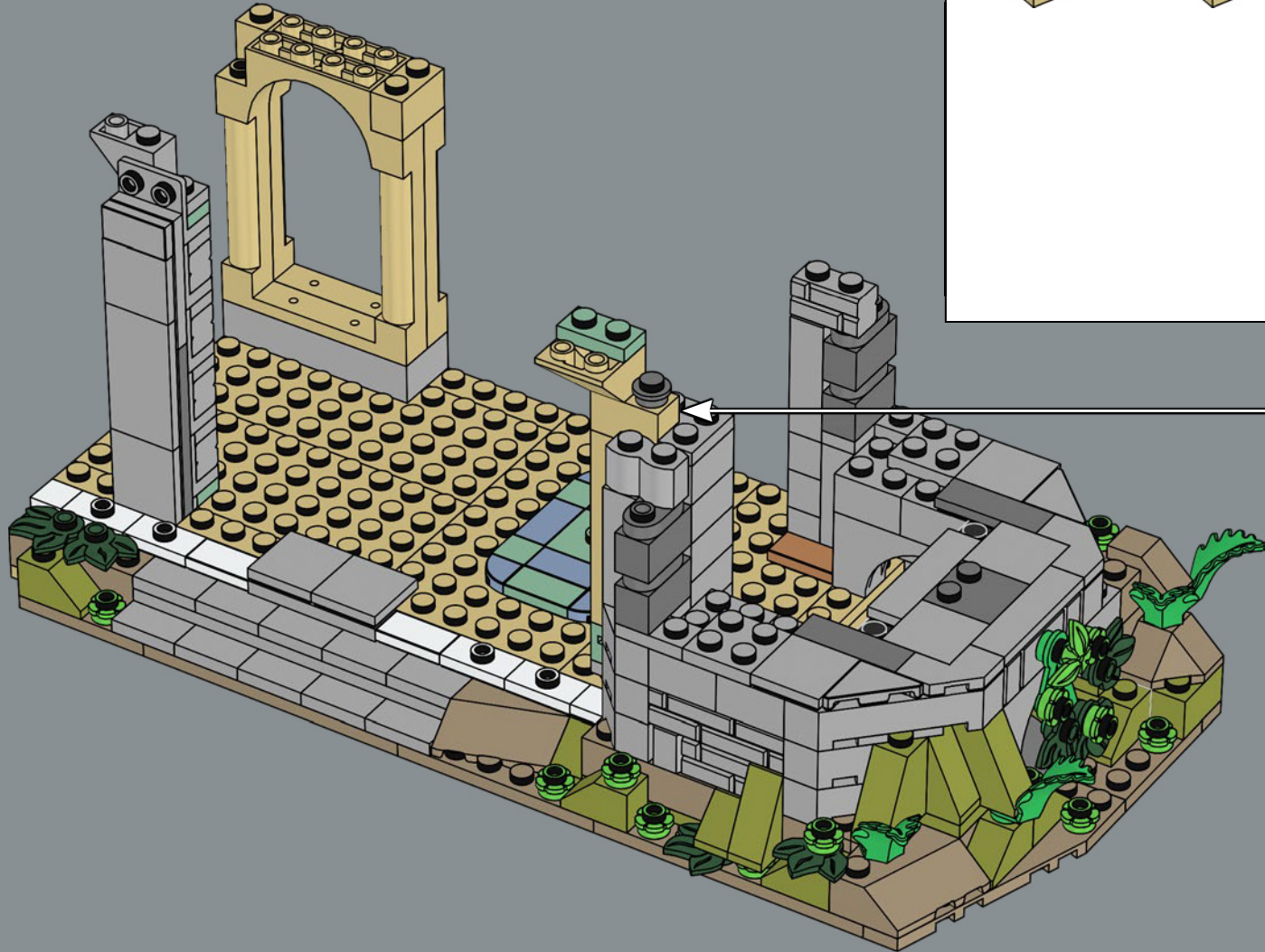

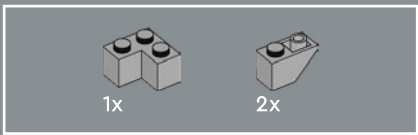

43

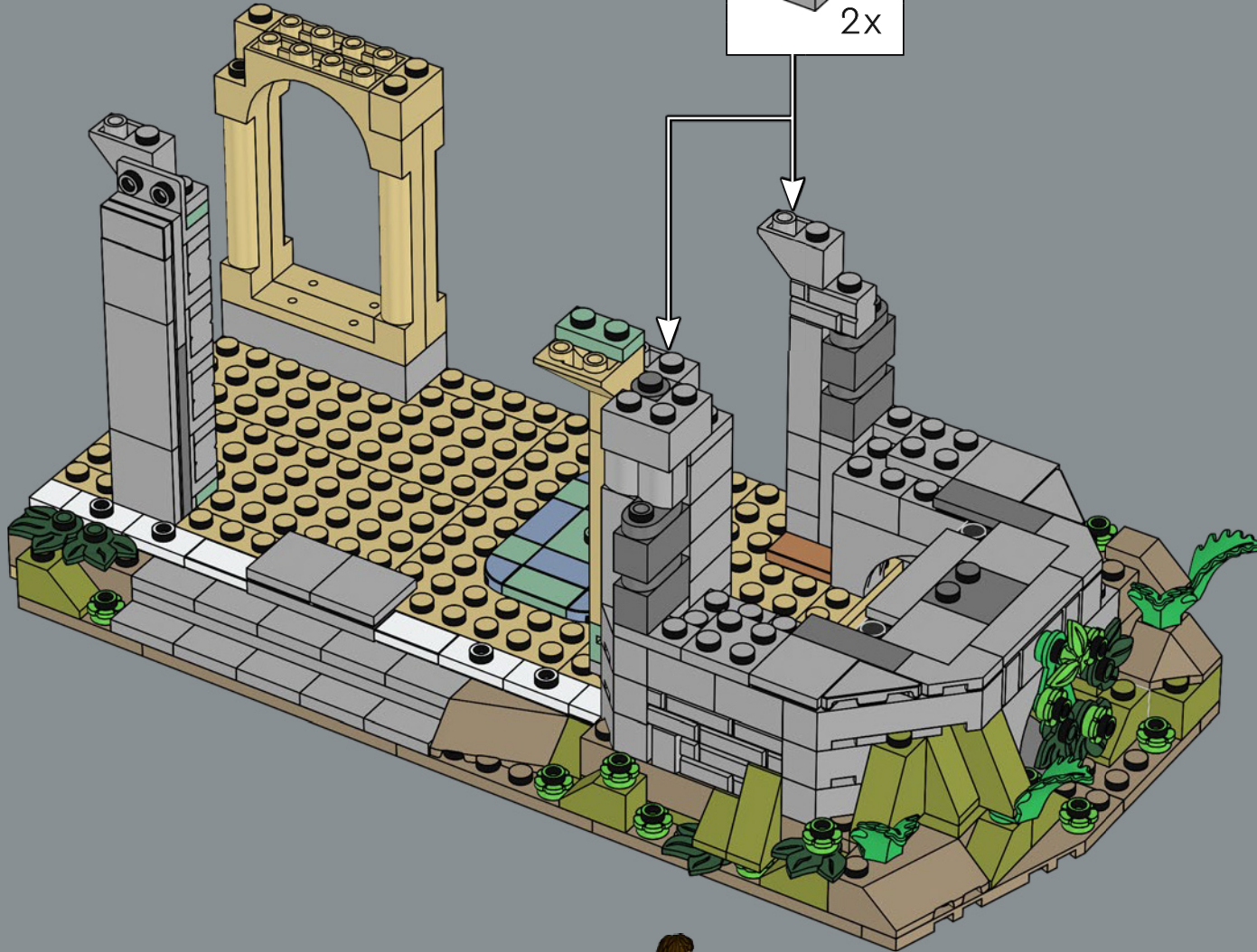
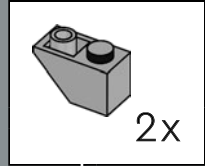

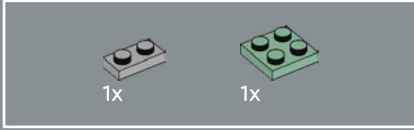
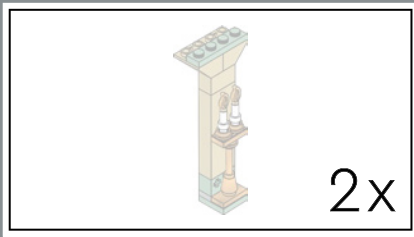

44

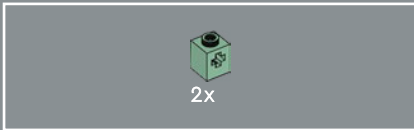
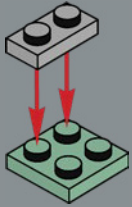

45

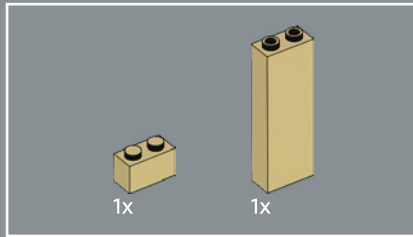
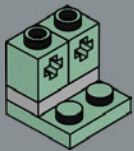

46

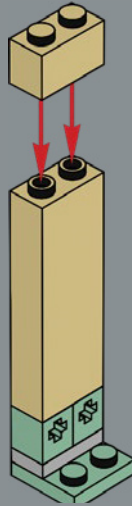

47

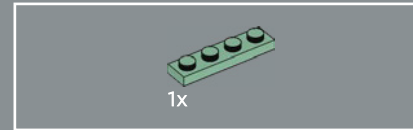
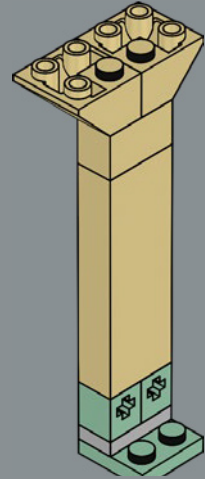

48

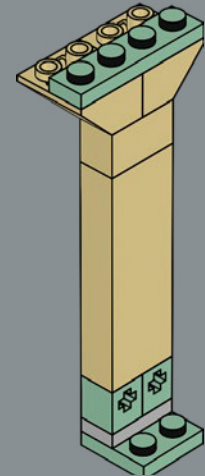

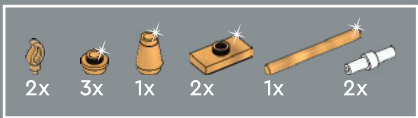

49

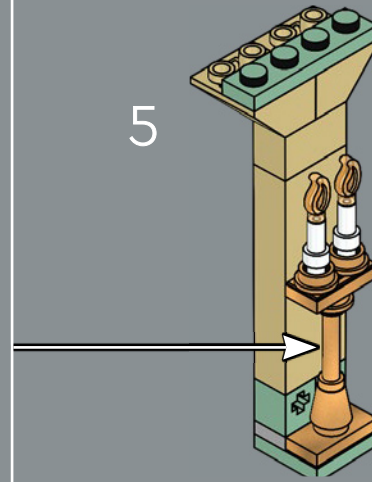
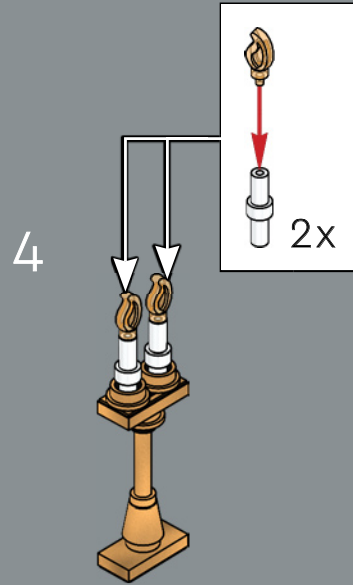
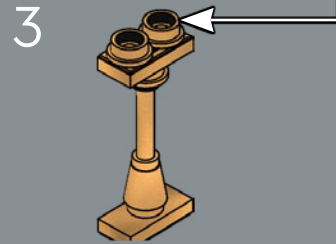
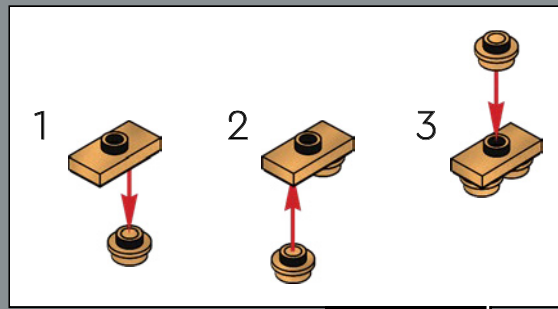
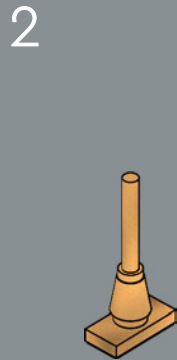
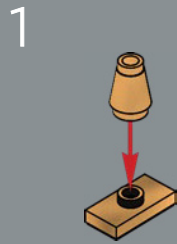

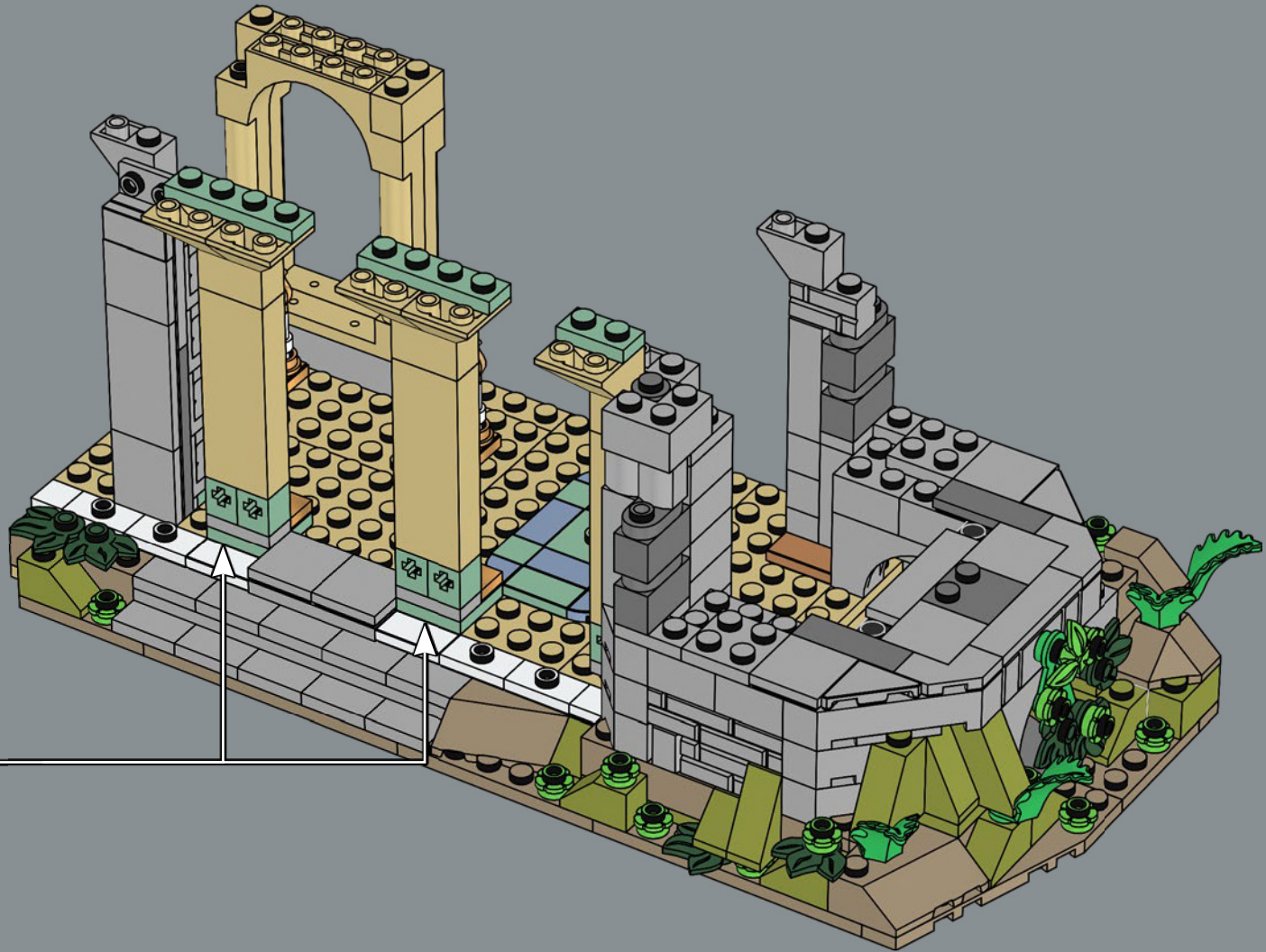

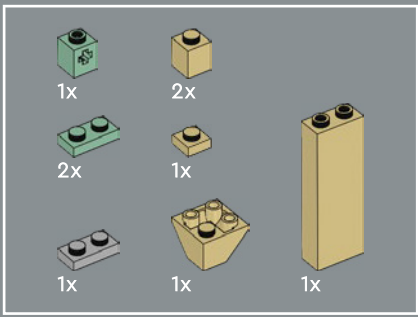

50

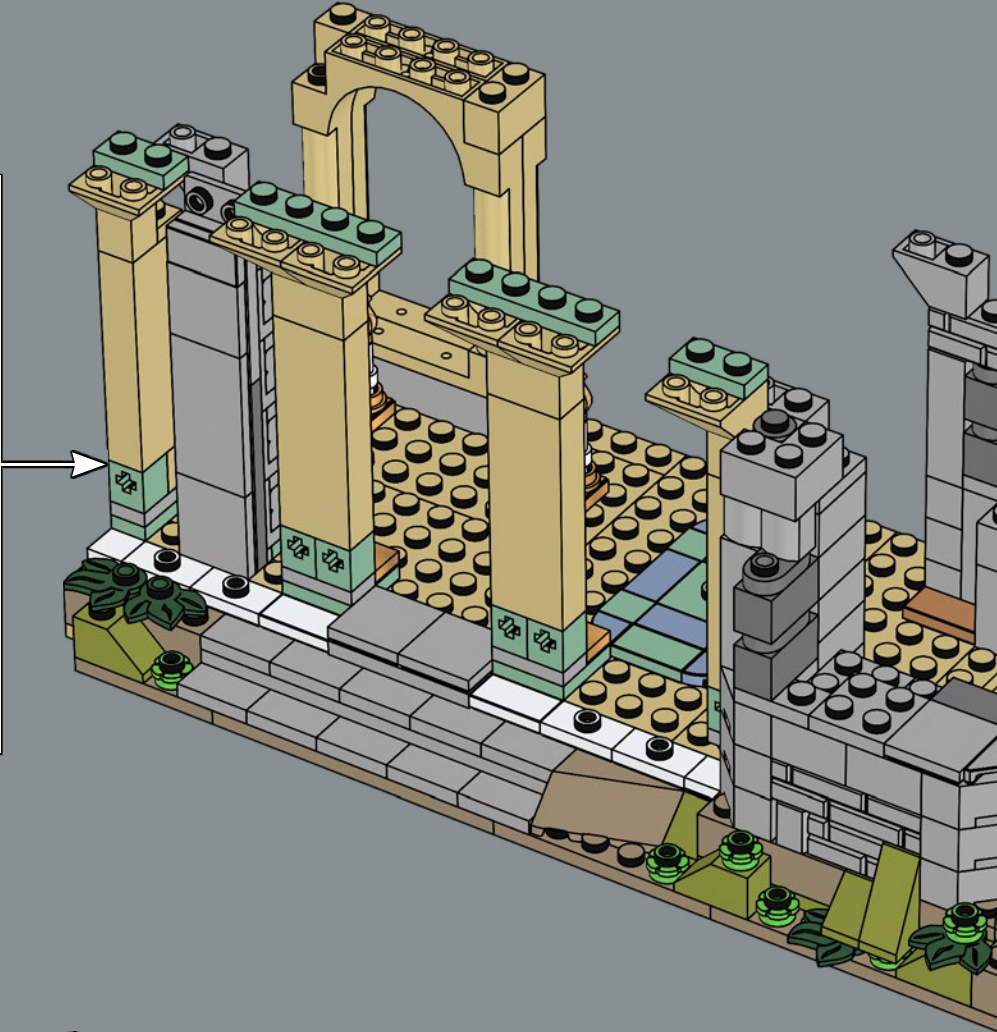
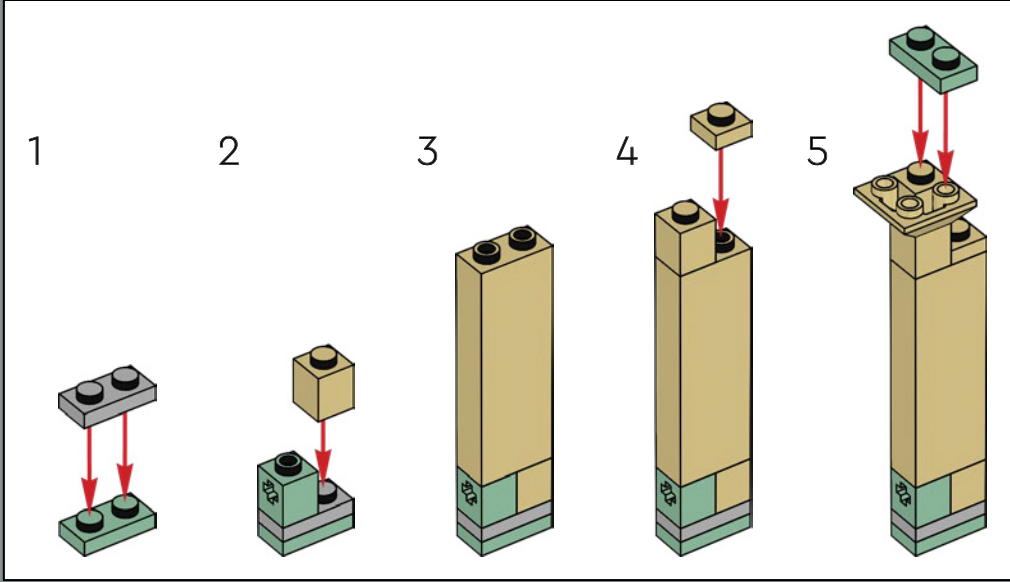



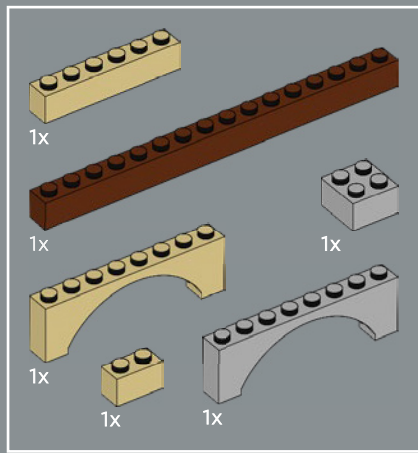

51

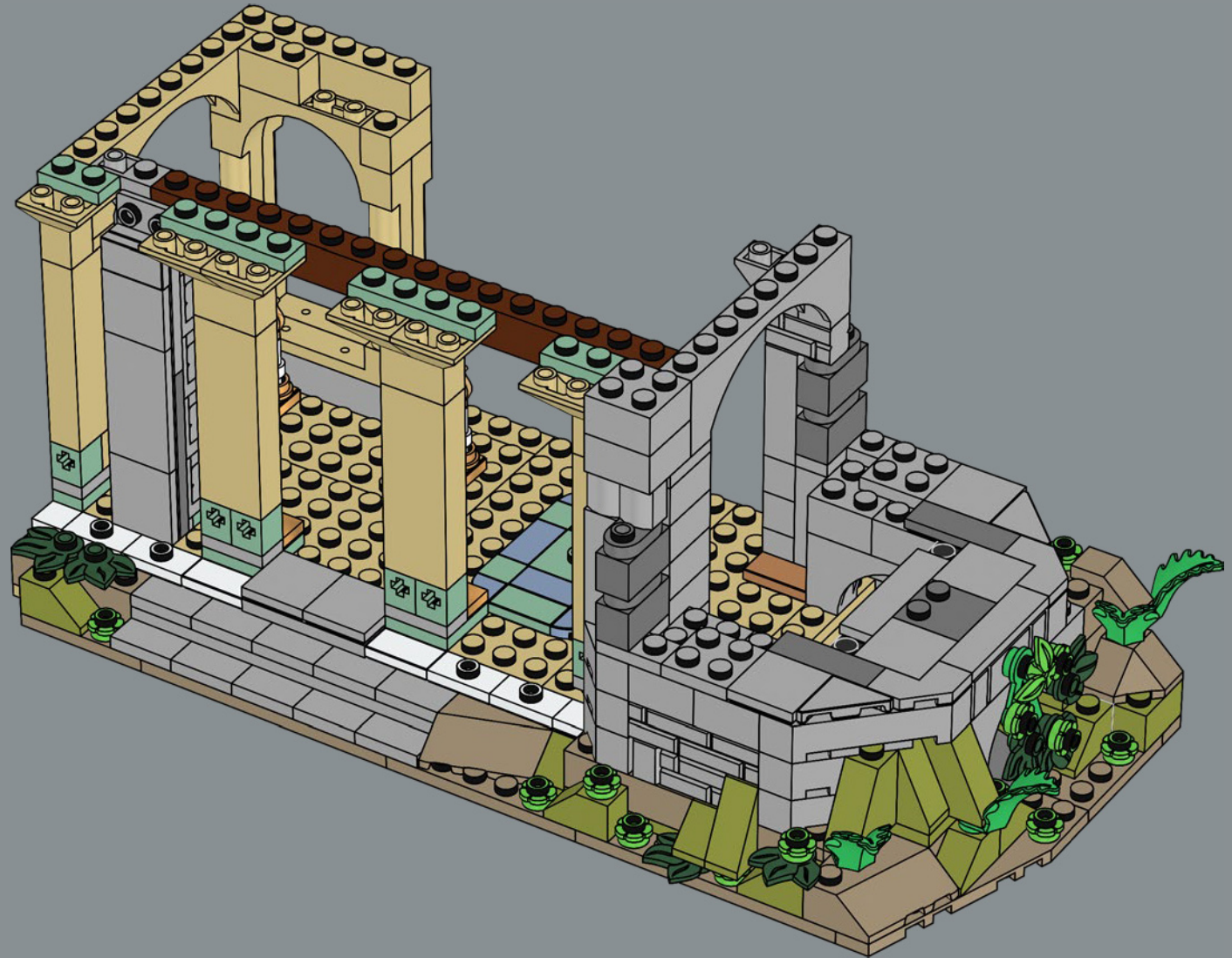

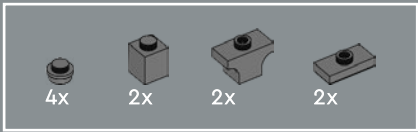

52

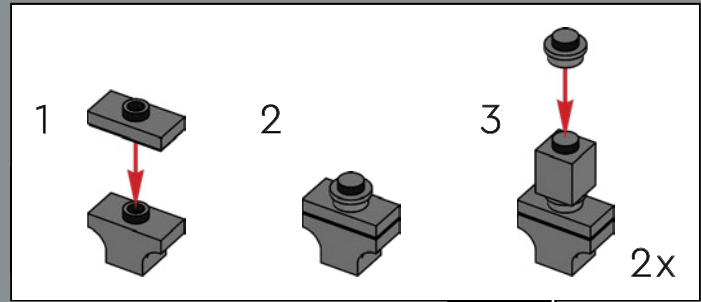
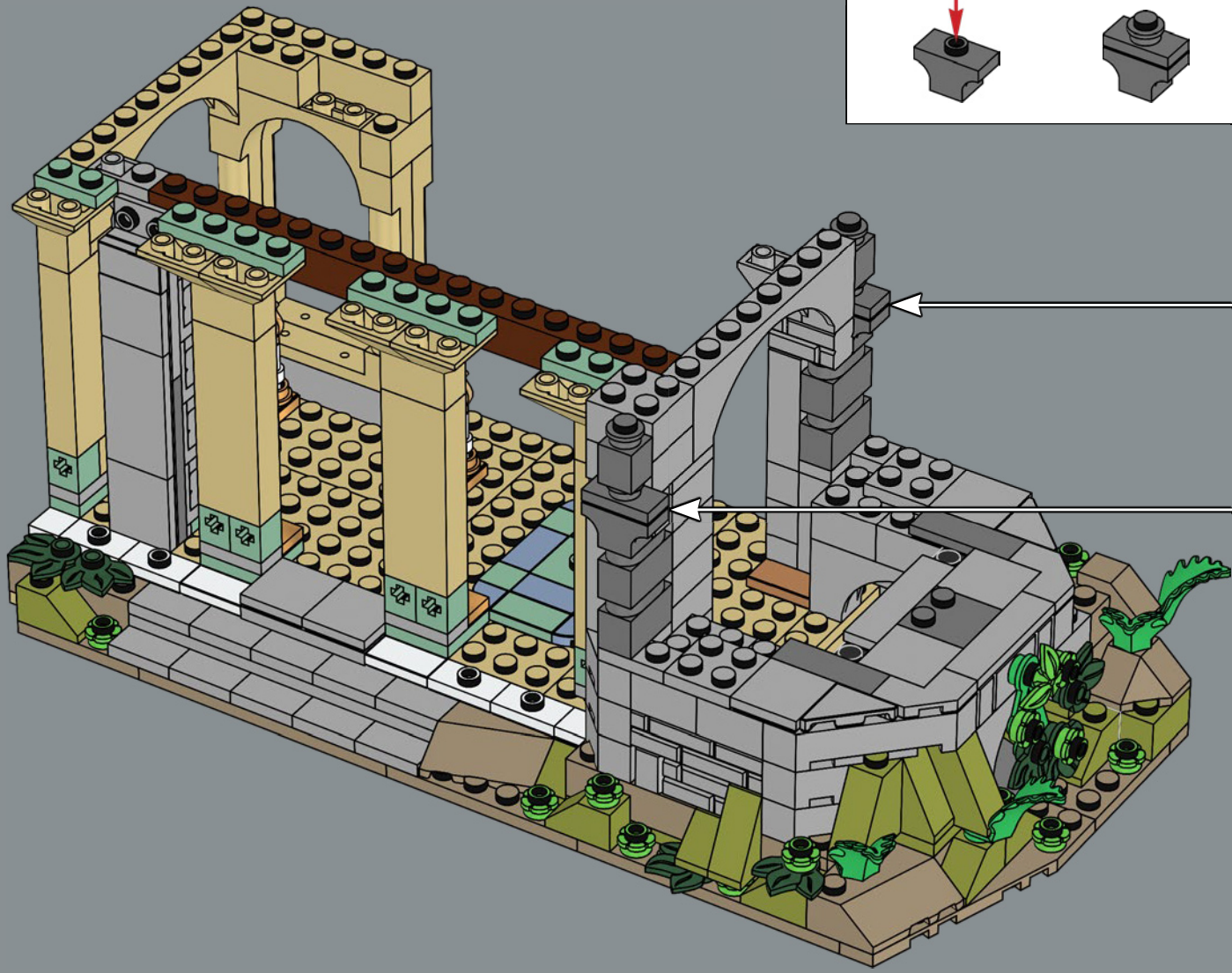

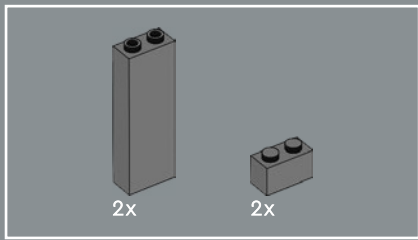

53

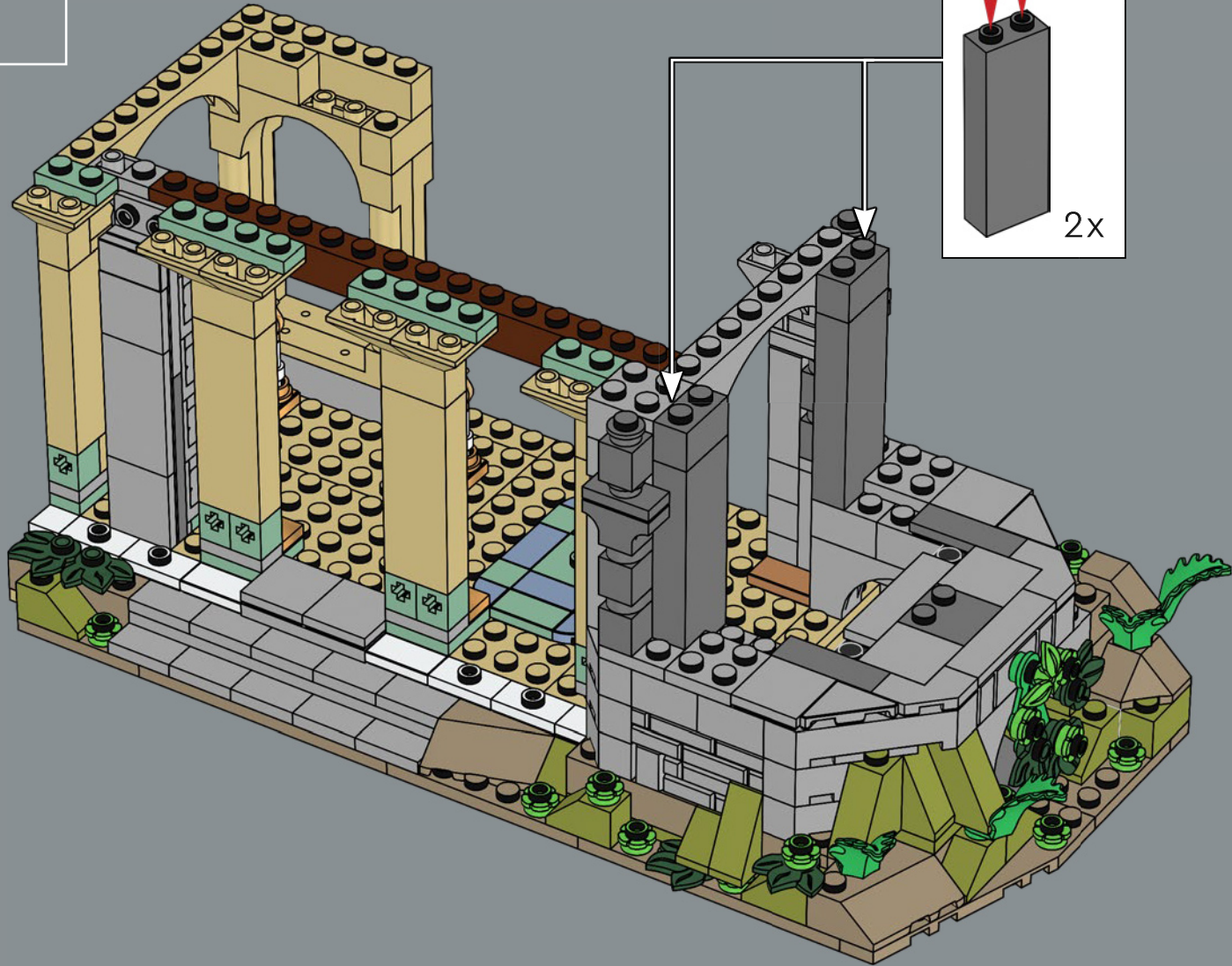



4x

54

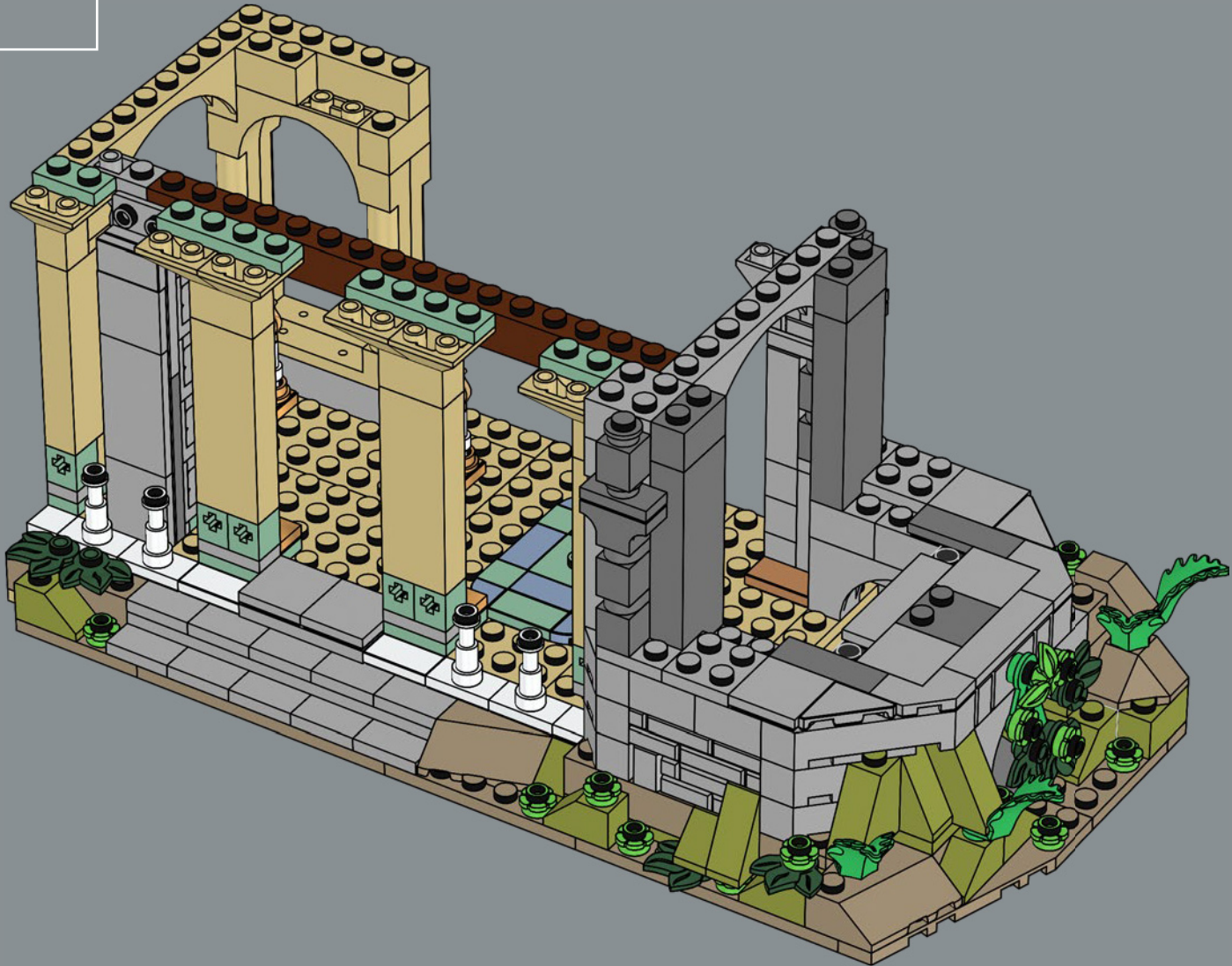

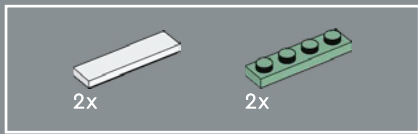

55

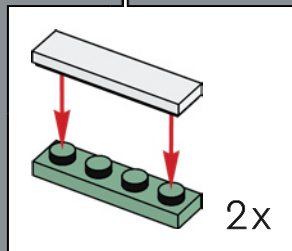
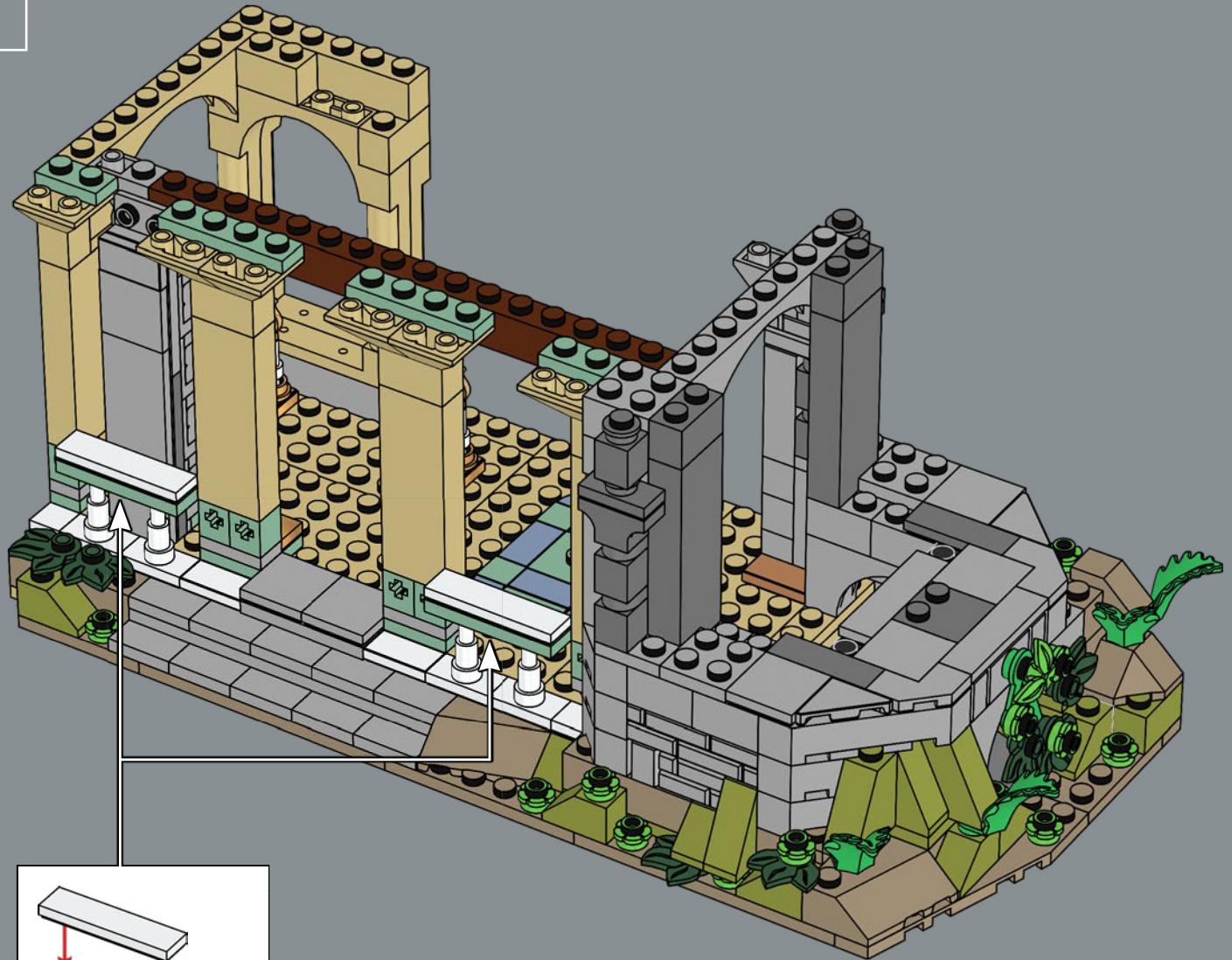

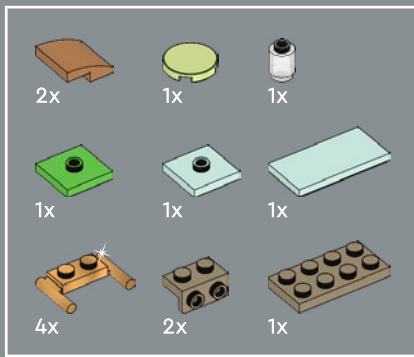

56

1



2

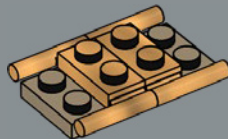

3

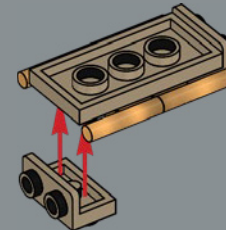

4

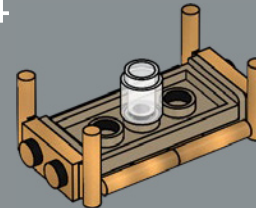

5

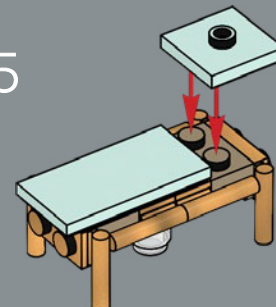

6

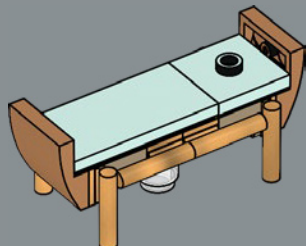

7

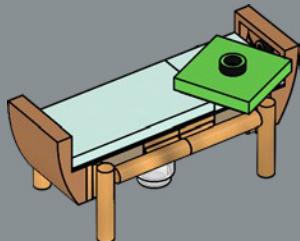

8

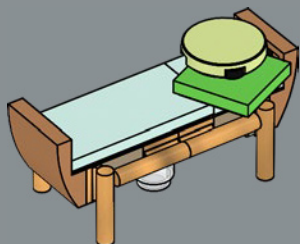

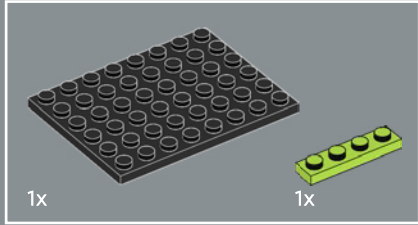
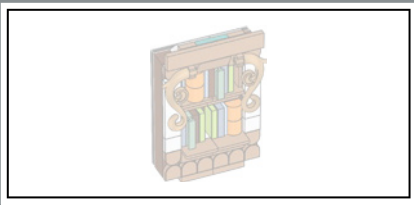

57

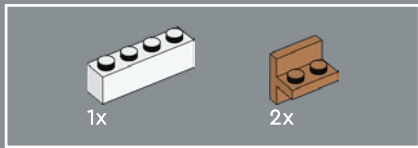
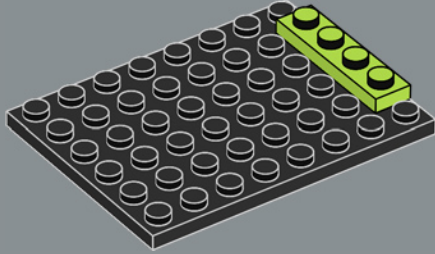

58

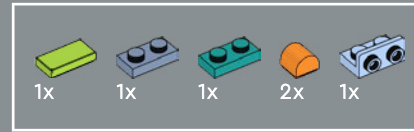
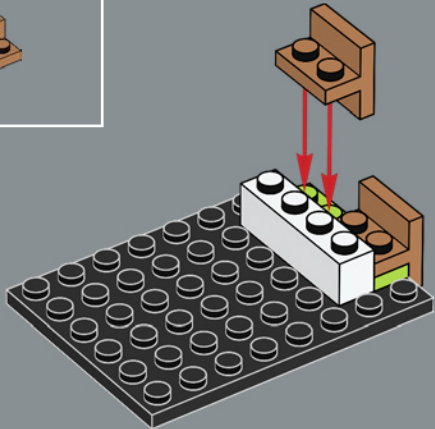

59

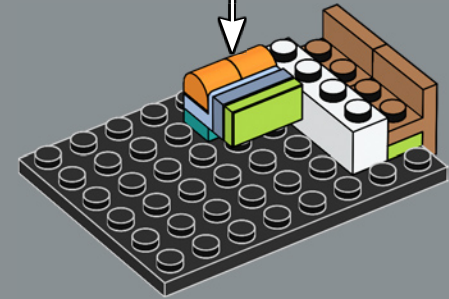
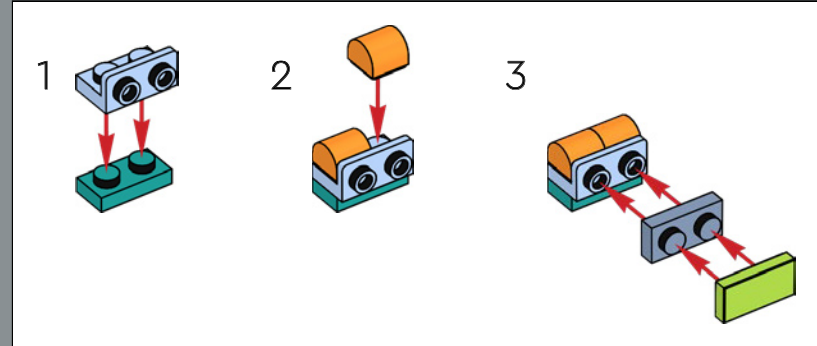



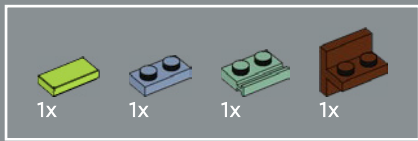

60

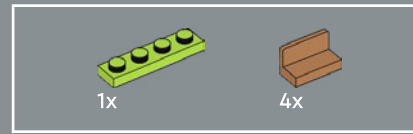
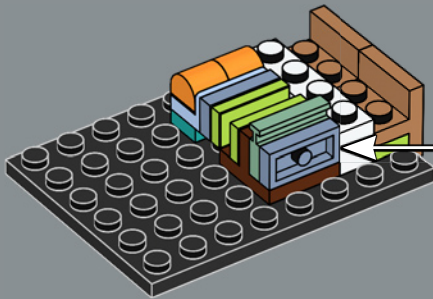
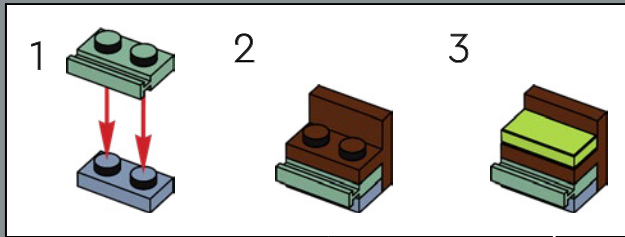

61

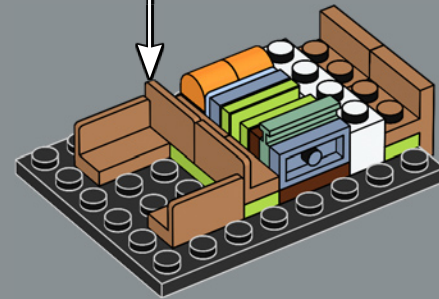
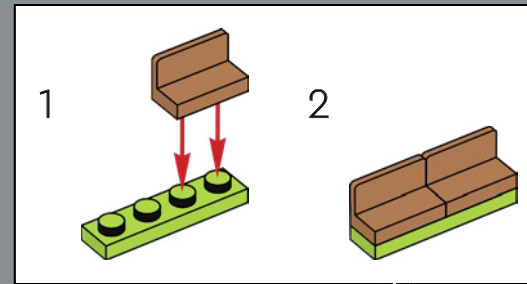

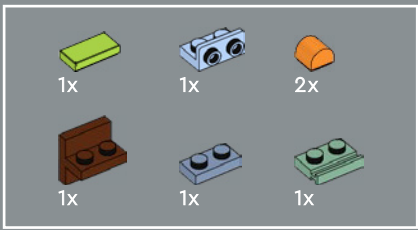

62

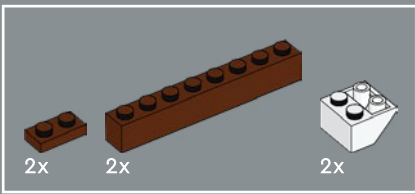
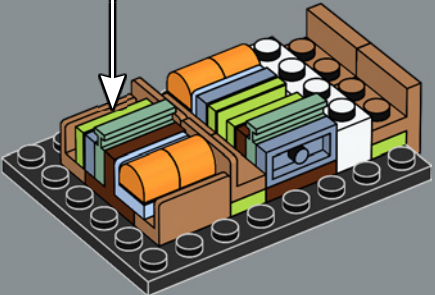
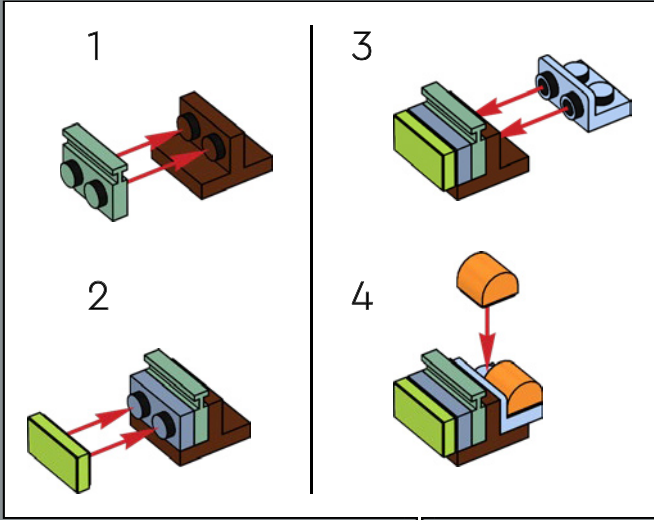

63

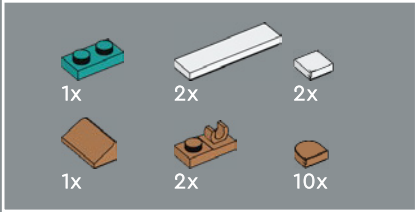
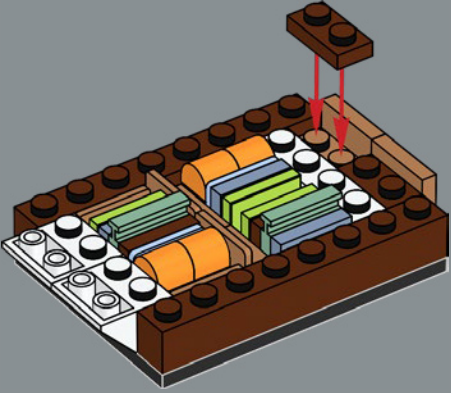

64

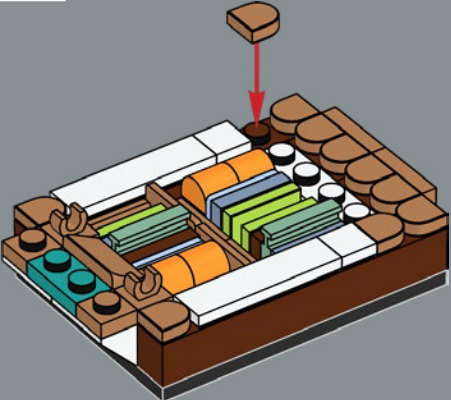

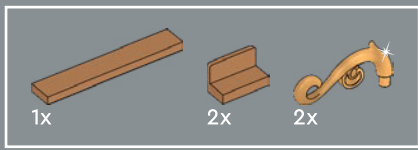

65

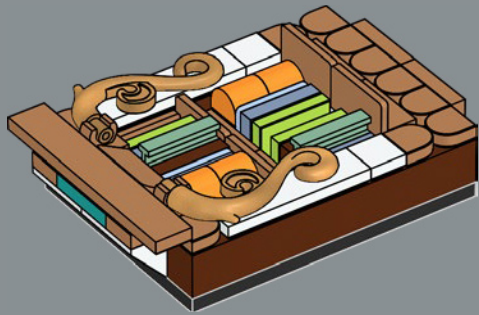

66

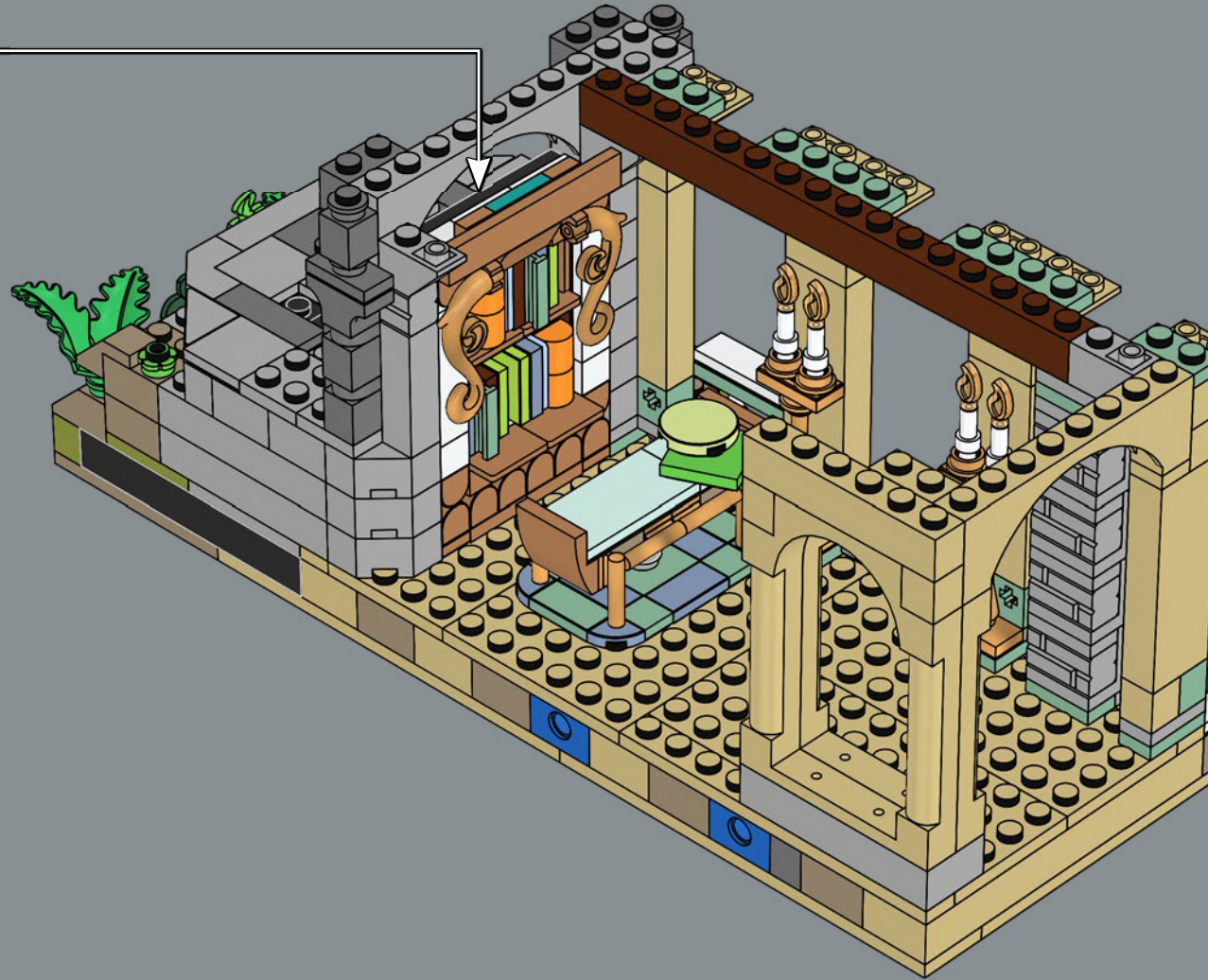

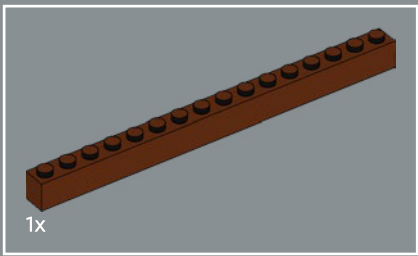

1x

67



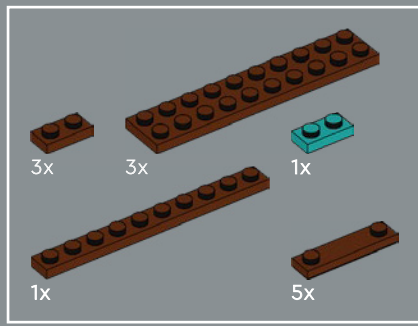

68

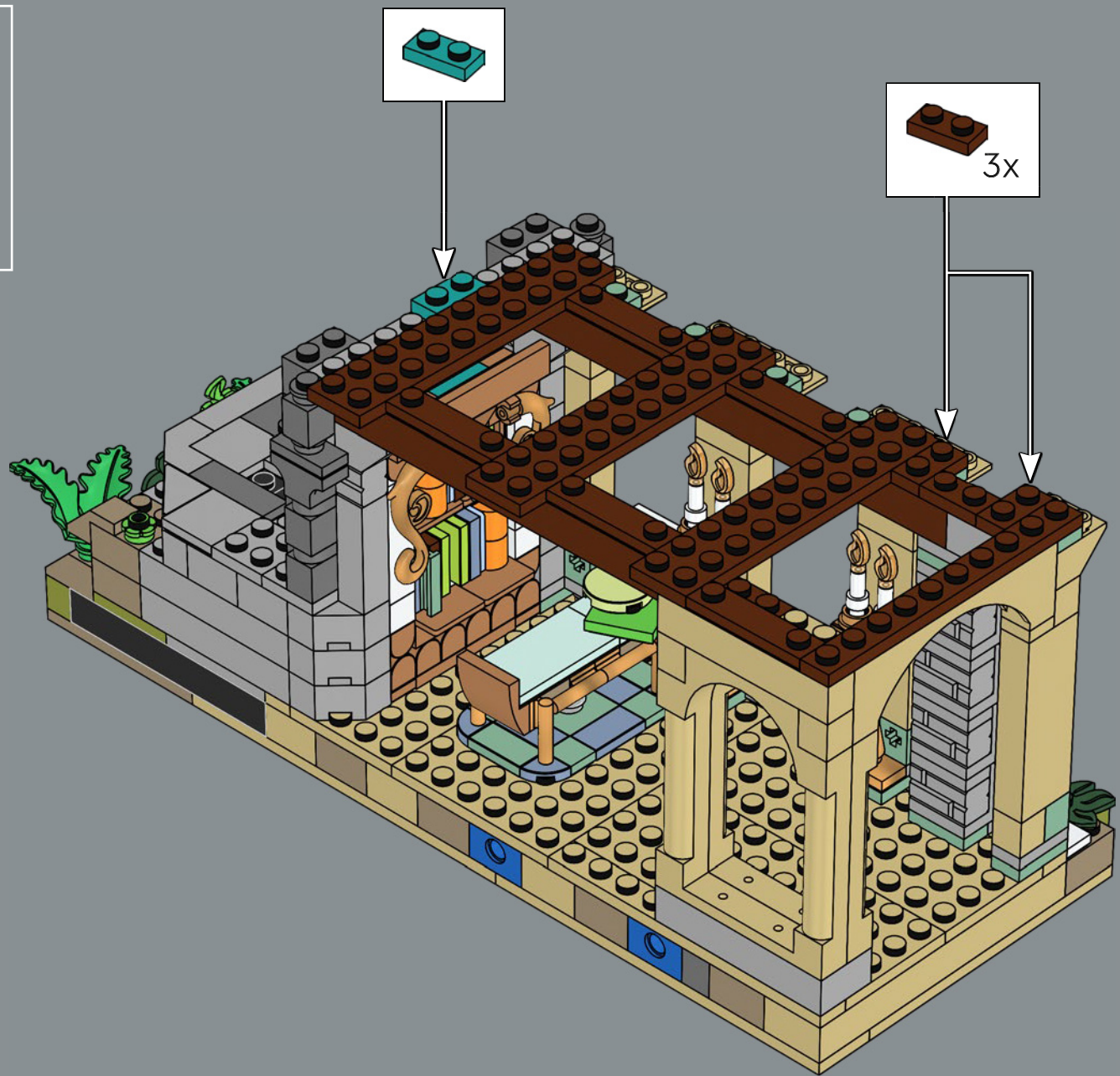

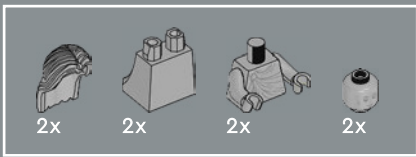

69

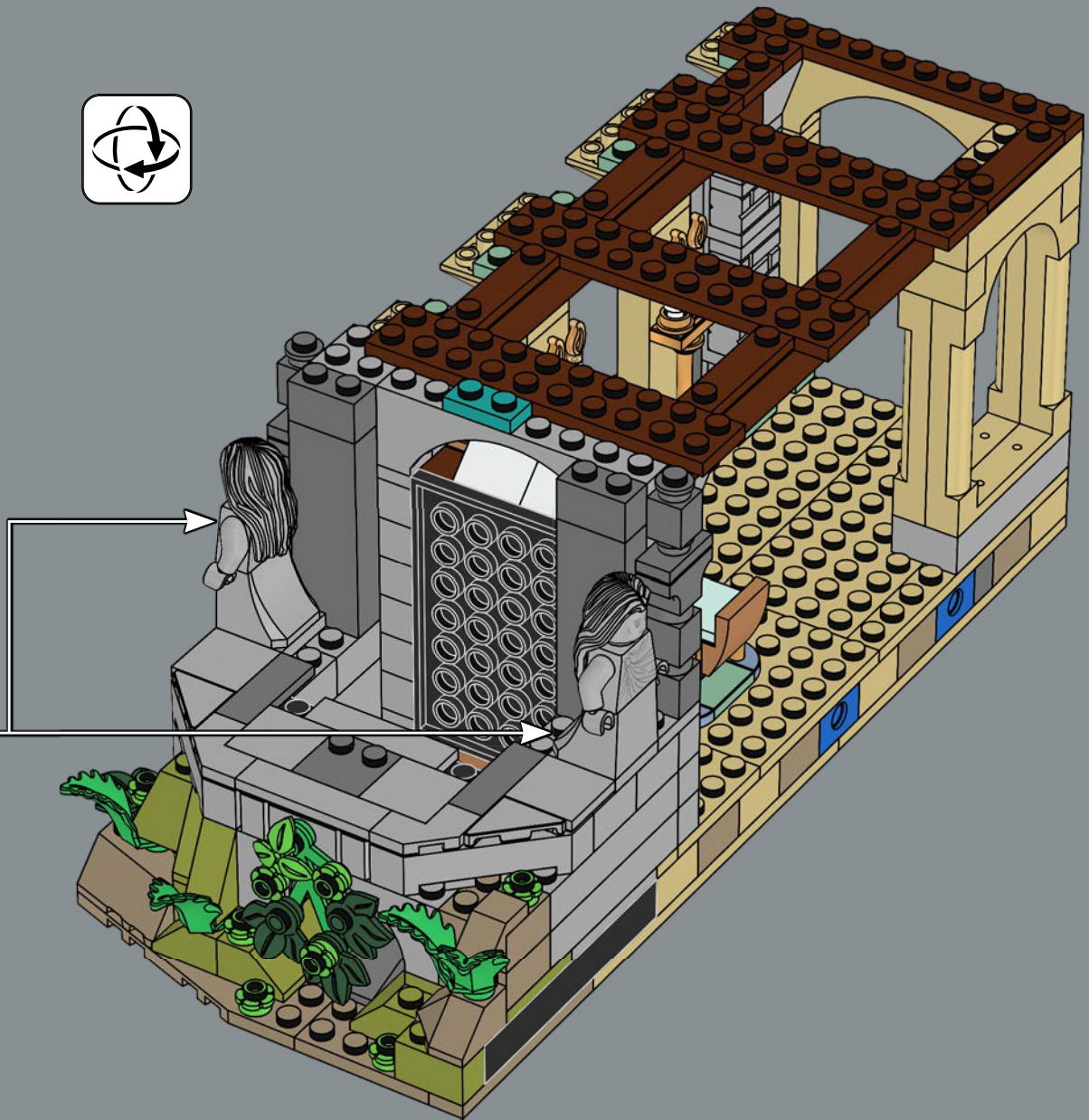
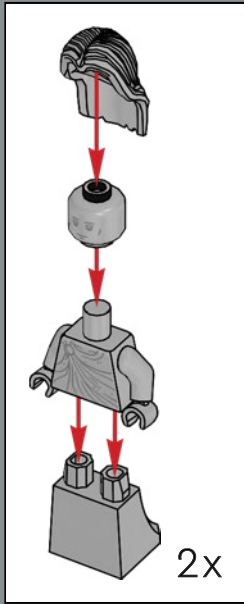

The new head decorations for the statues feature two distinct expressions: stone-faced and a hard stare!





70

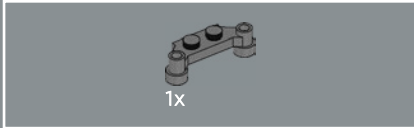
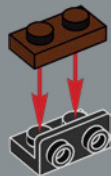

71

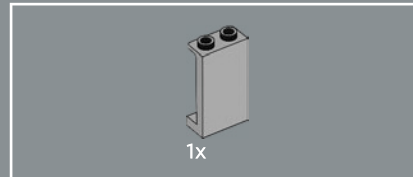
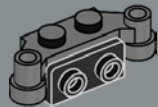

72

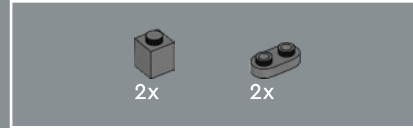
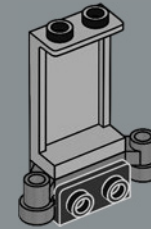

73

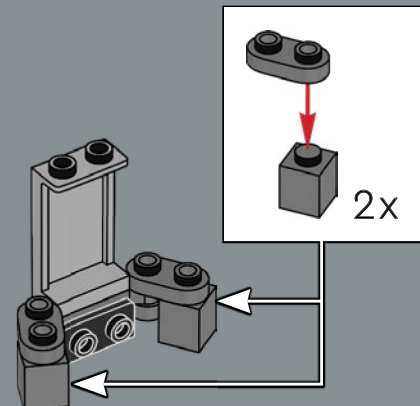



2x

74

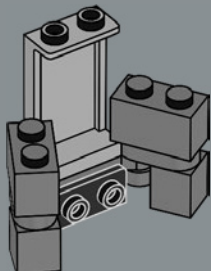

2x

75

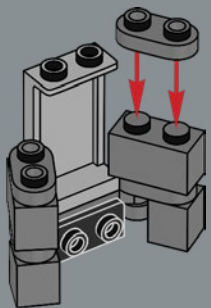

2x



2x

76

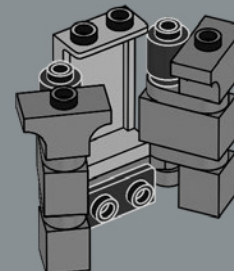

1x

77

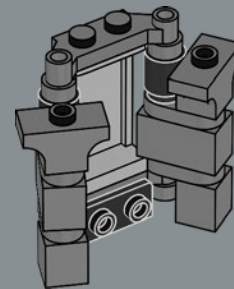



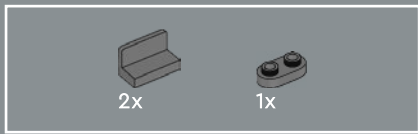

78

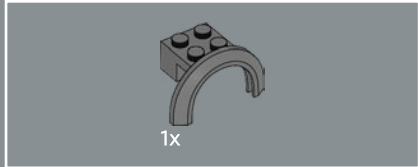
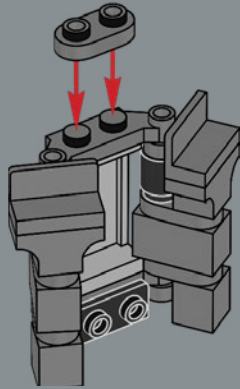

79

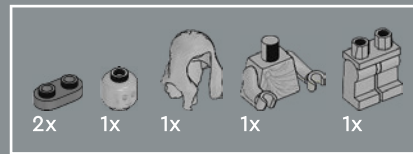
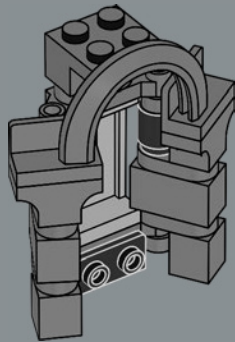

80

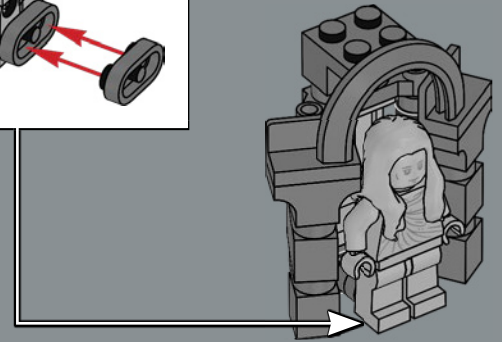
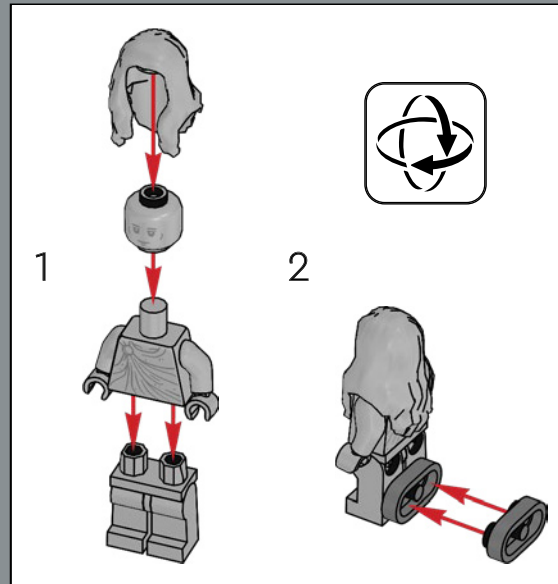



1x

81

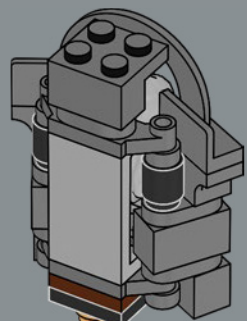

2x



82

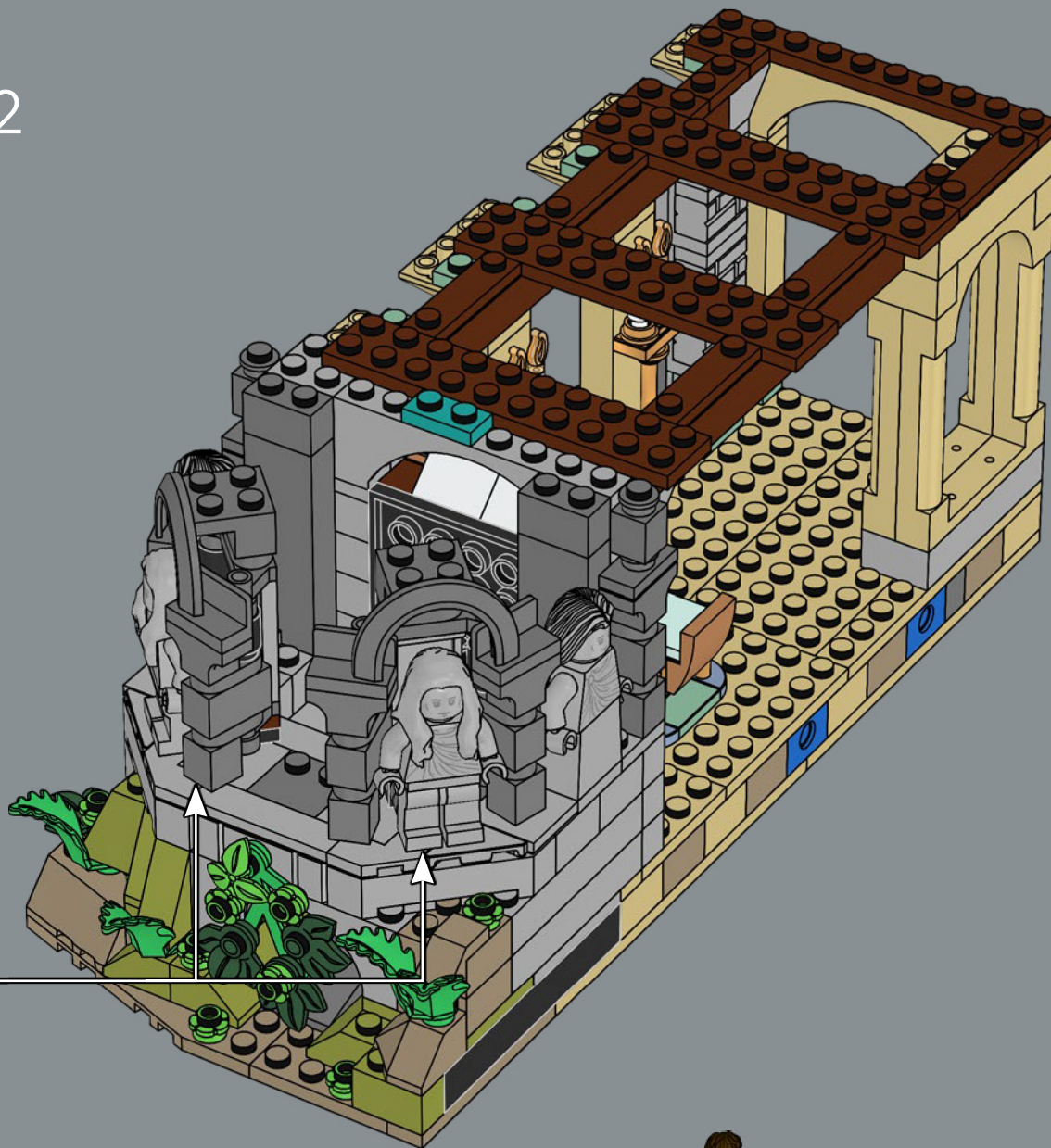

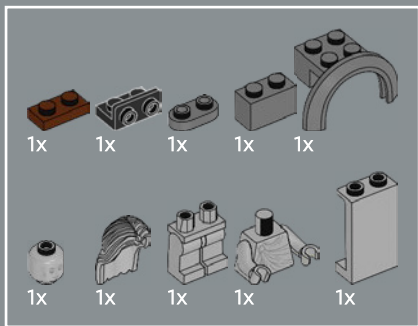

83

1

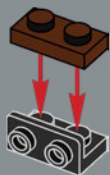

2

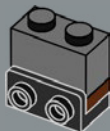

3

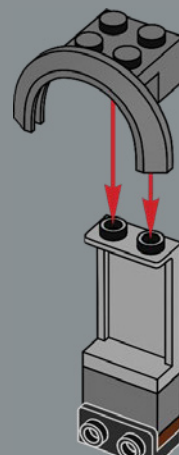

4

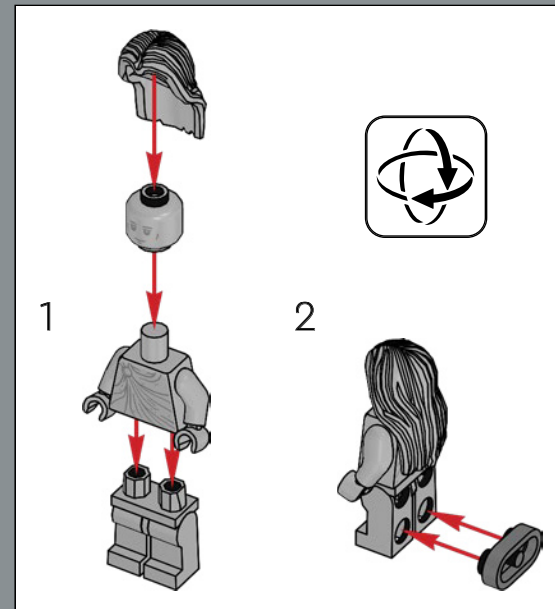

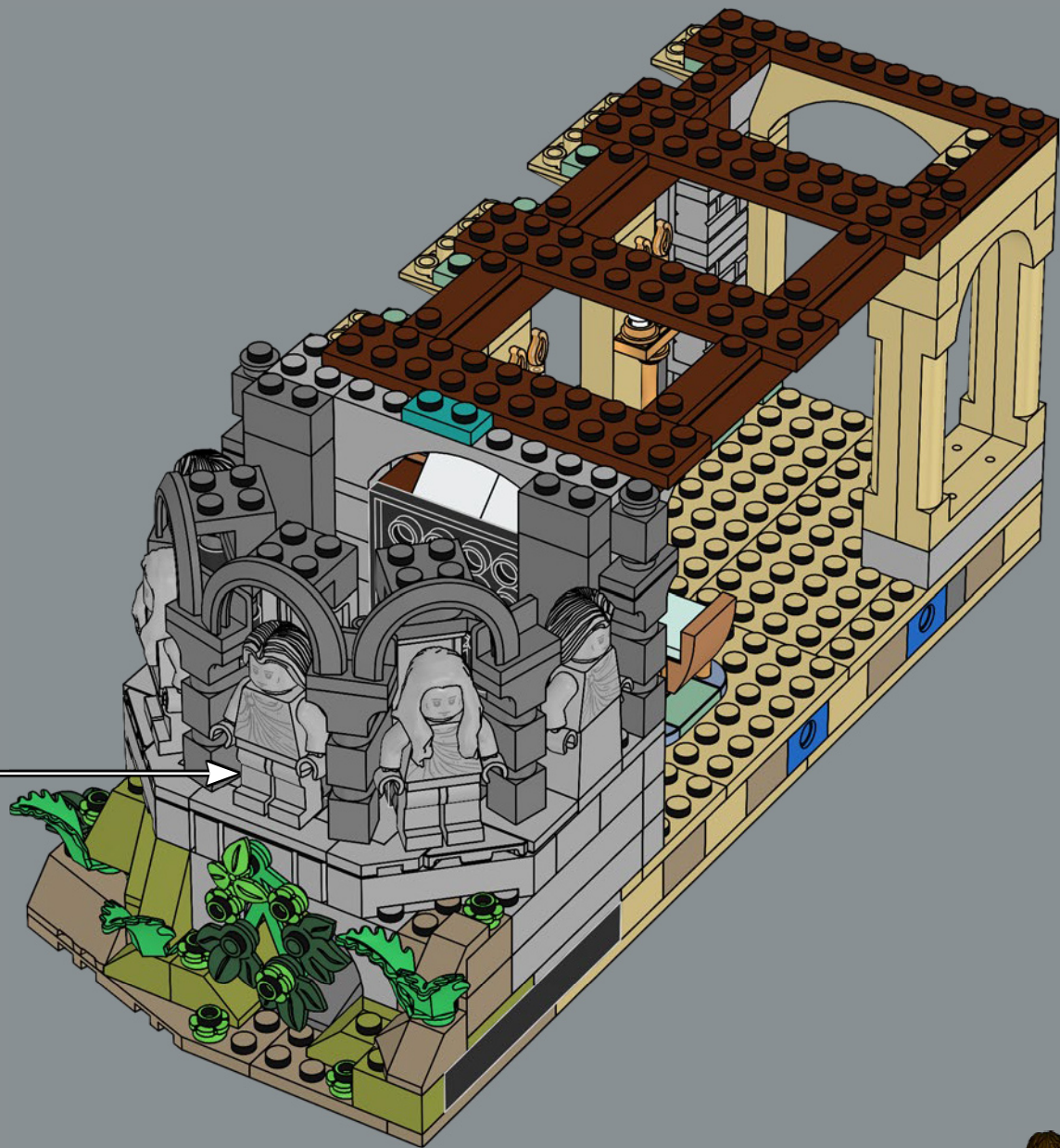

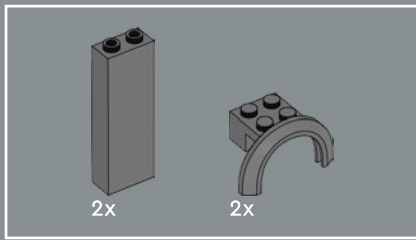

84

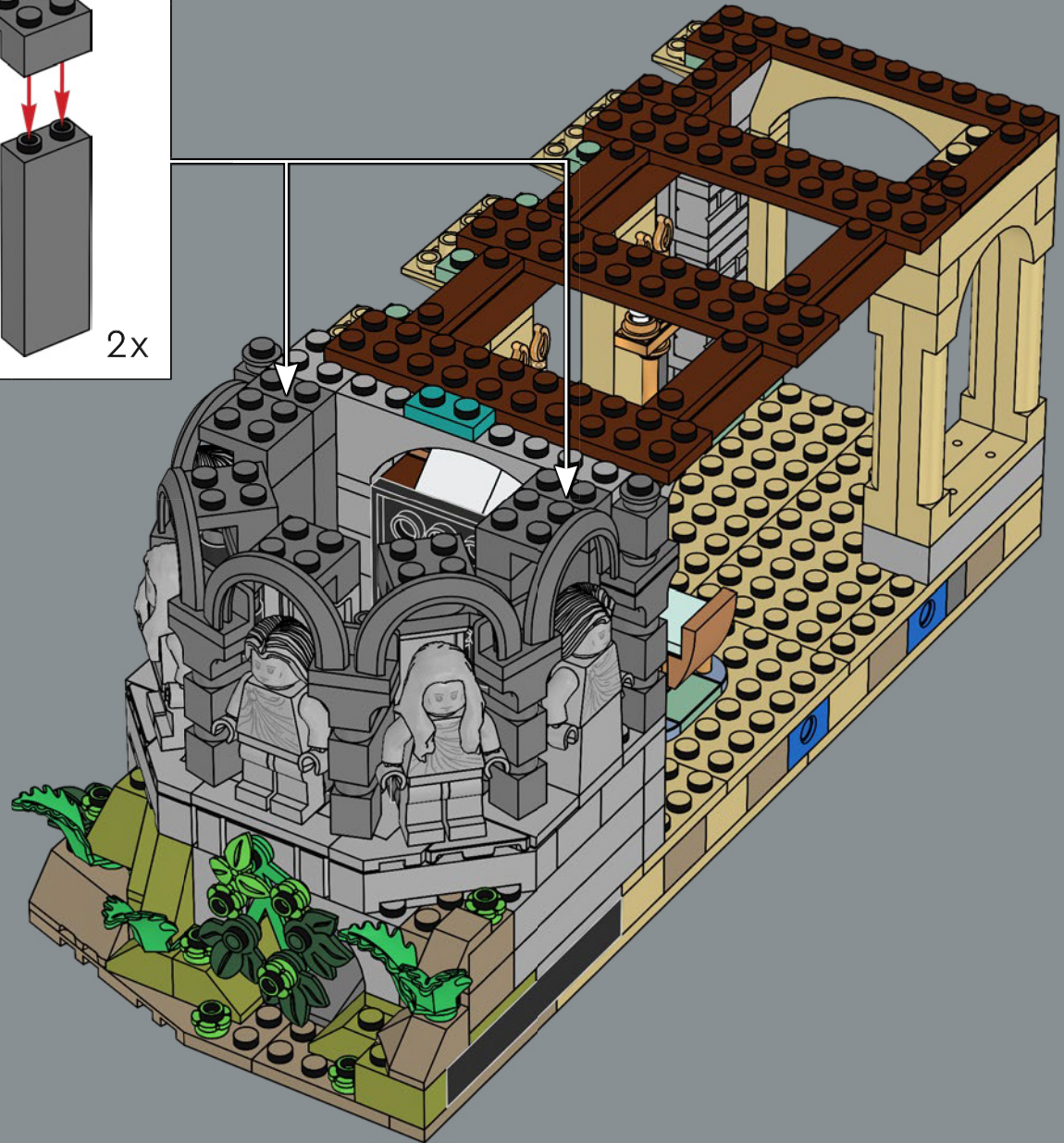
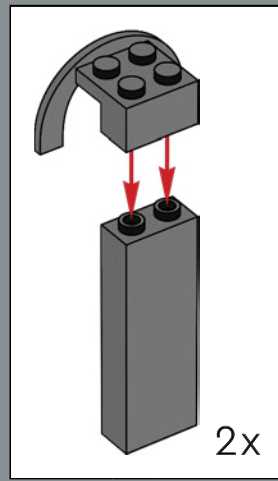

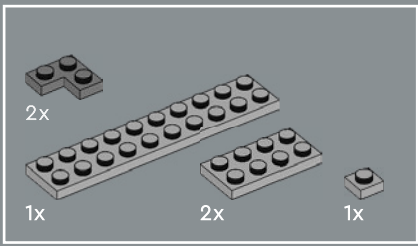

85

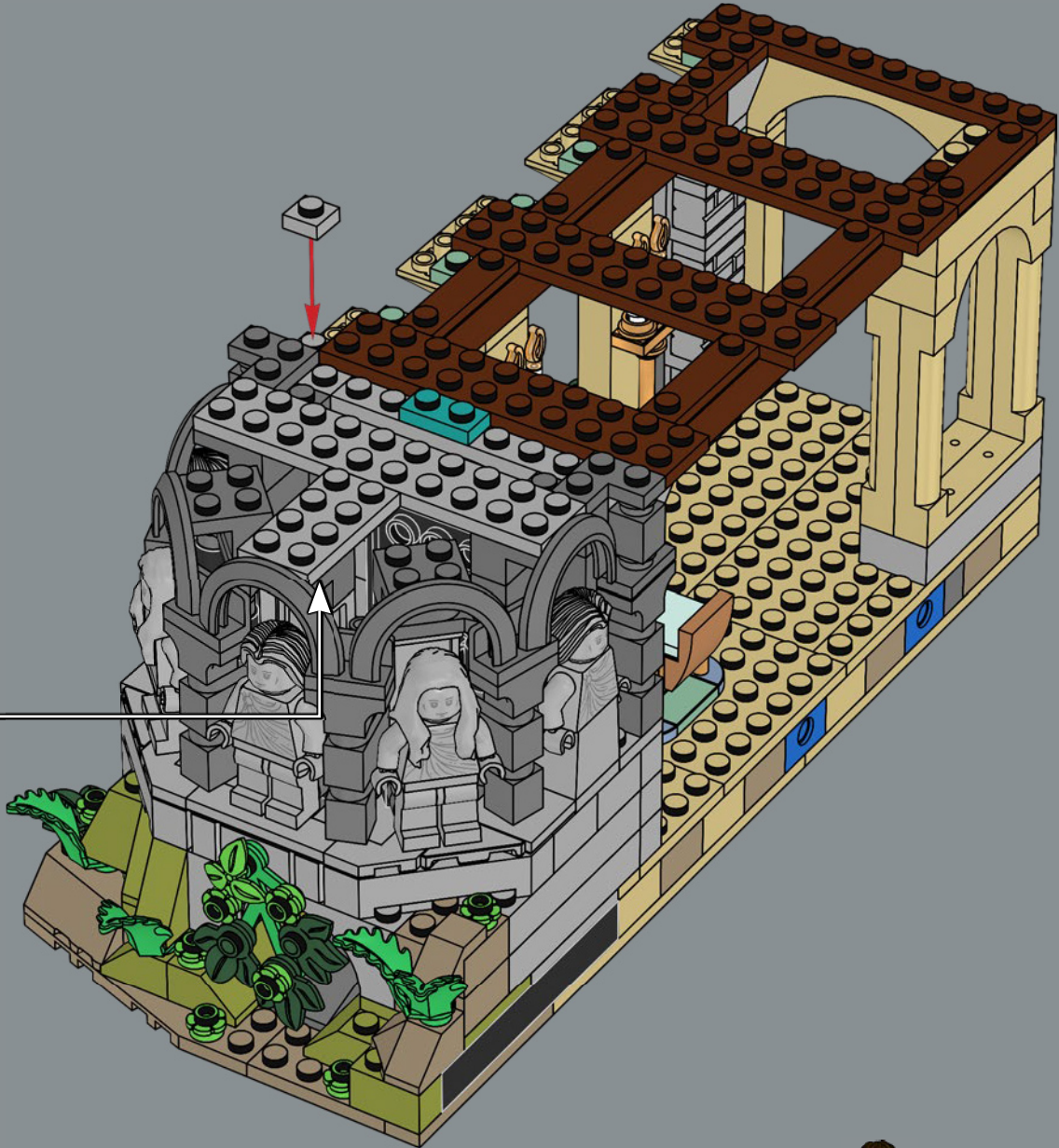
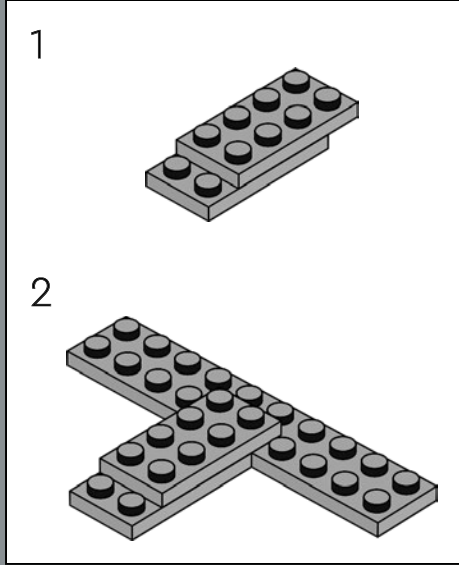

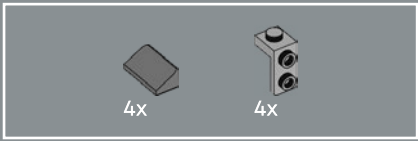

86

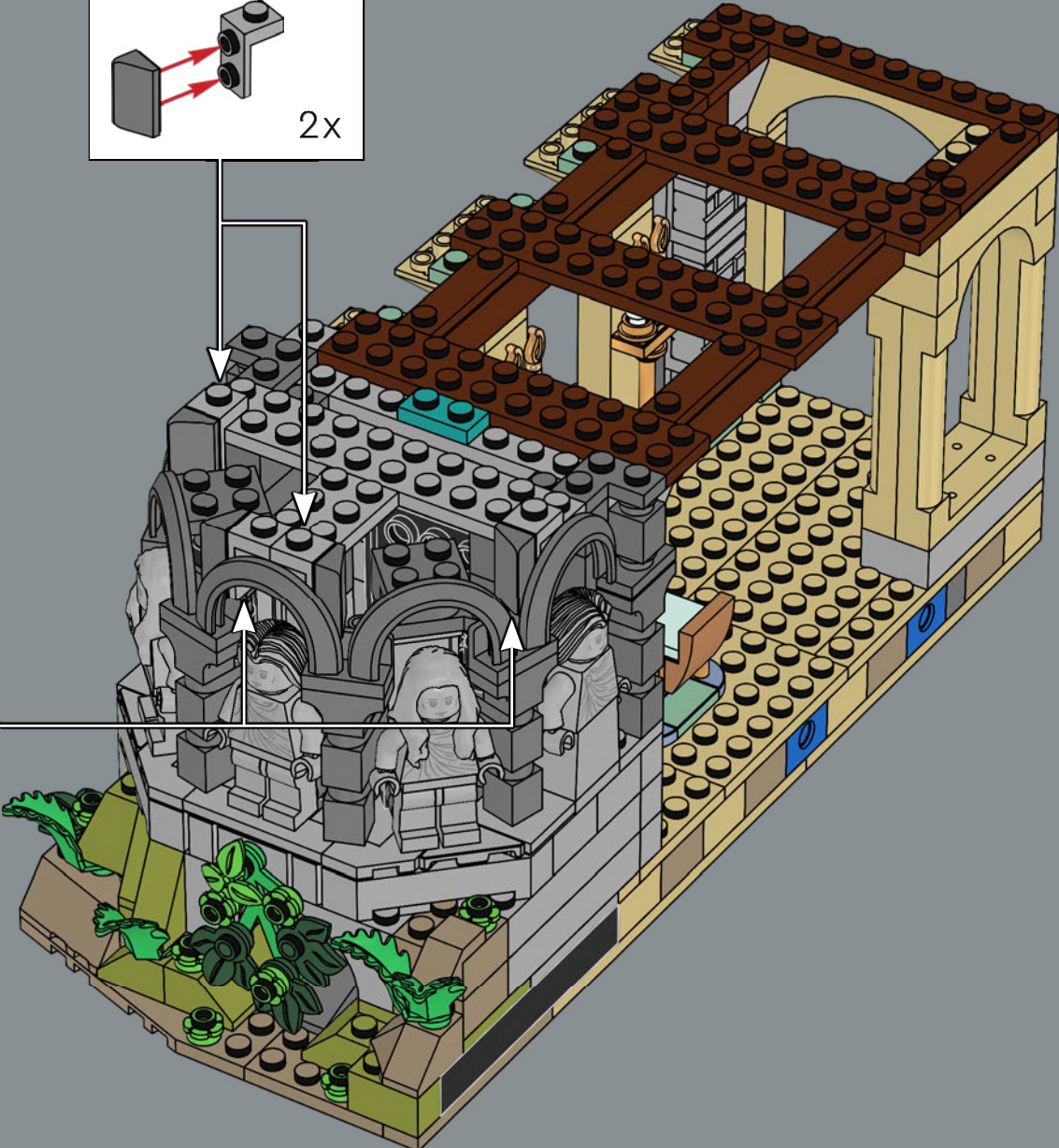
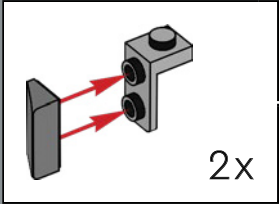
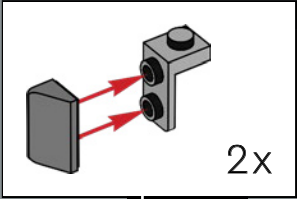

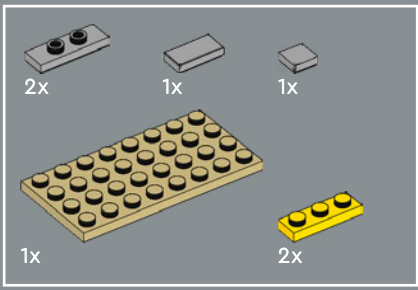

87





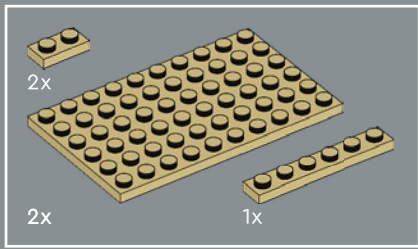

88



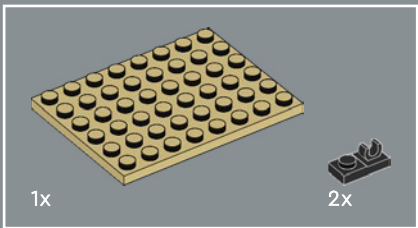
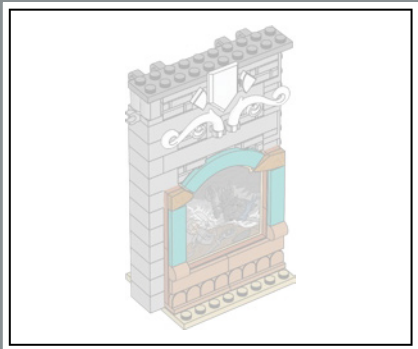

89

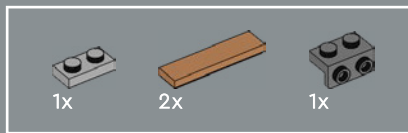
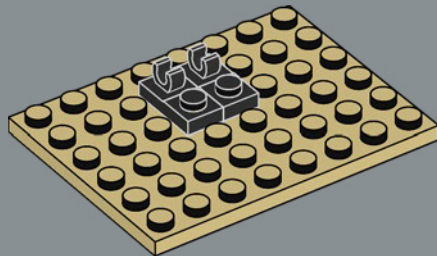

90

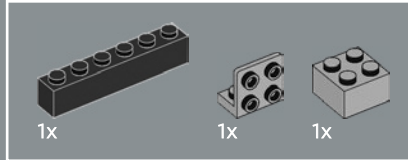
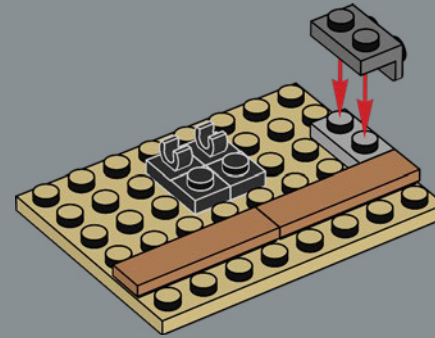

91

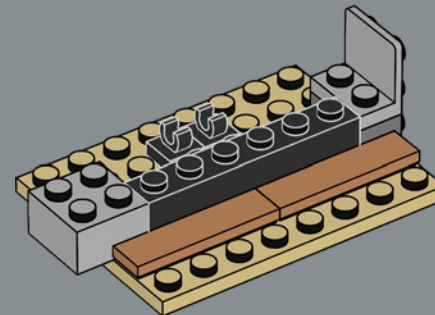

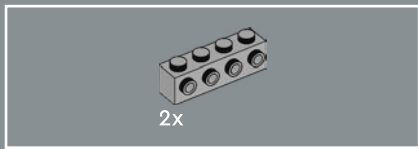

92

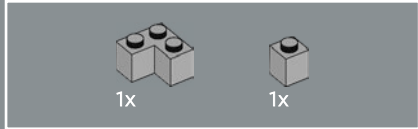
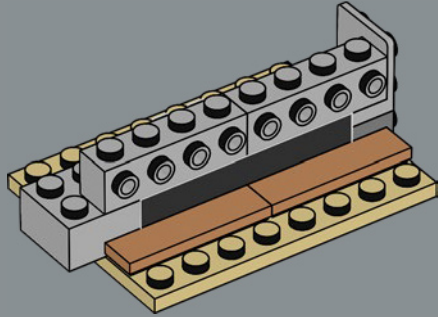

93

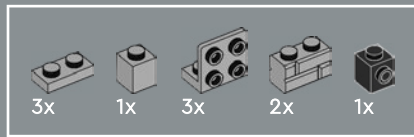
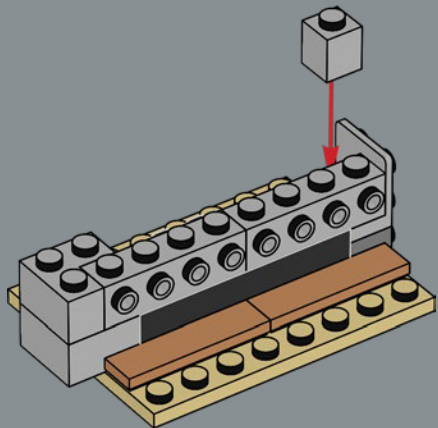

94

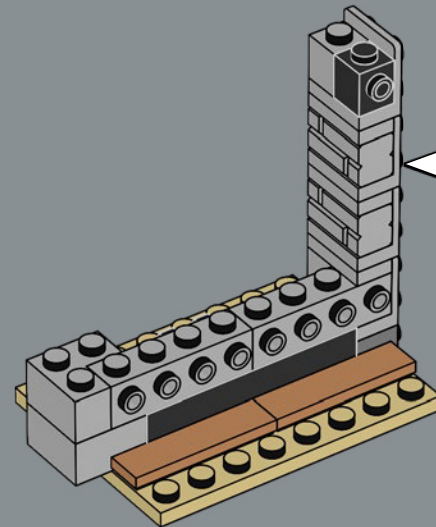
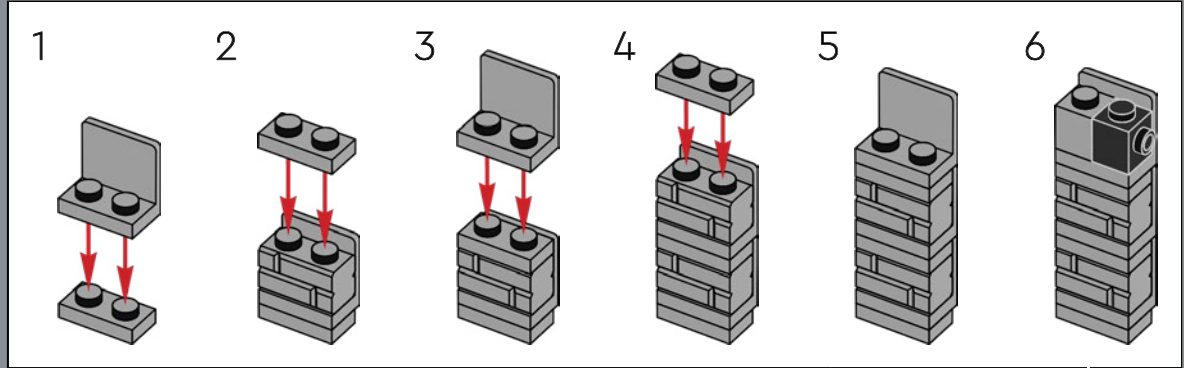

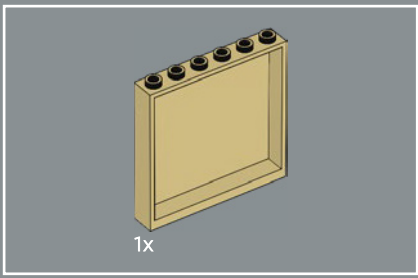

95

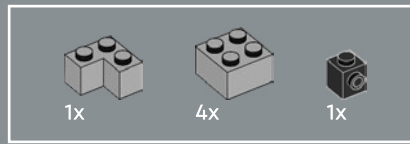
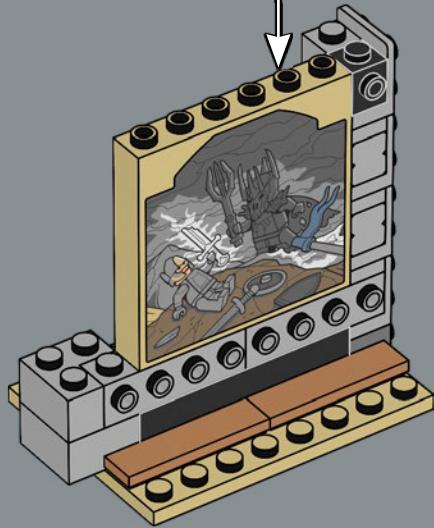
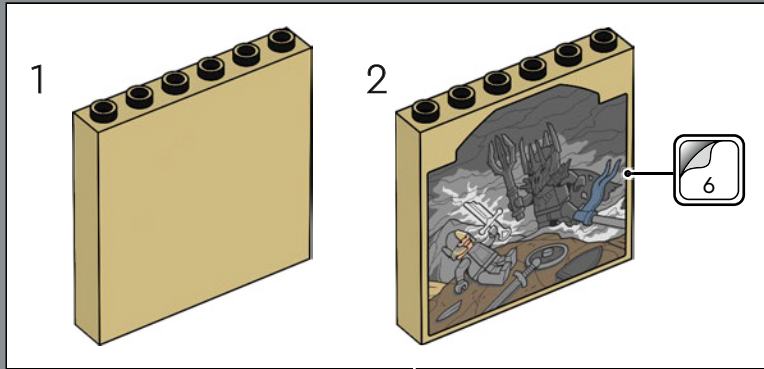

96

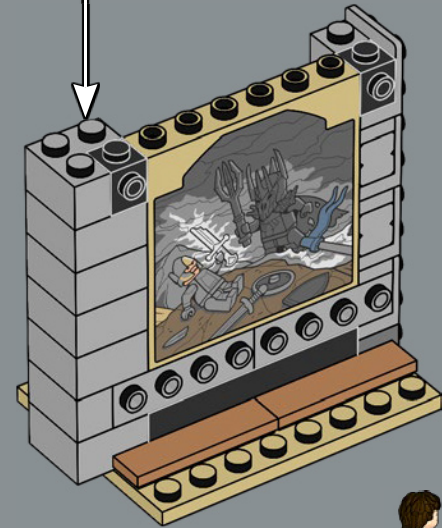
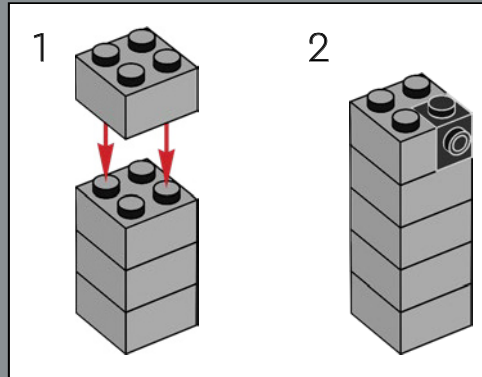

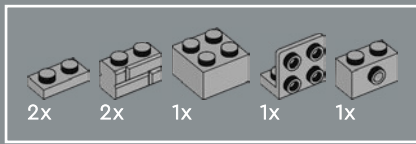

97

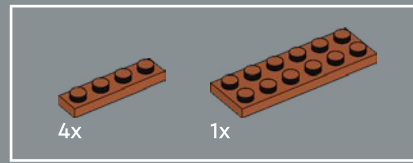
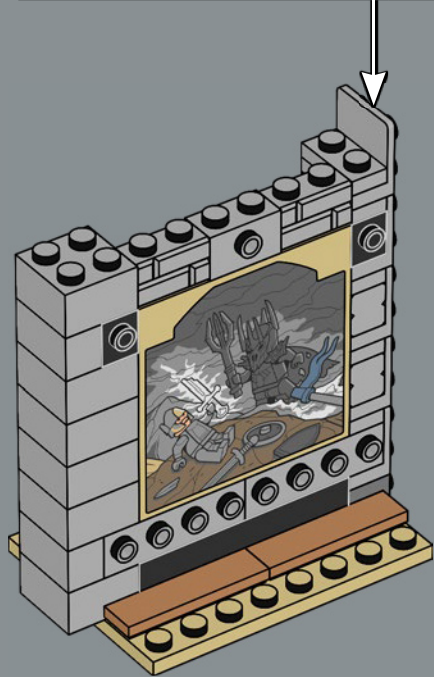
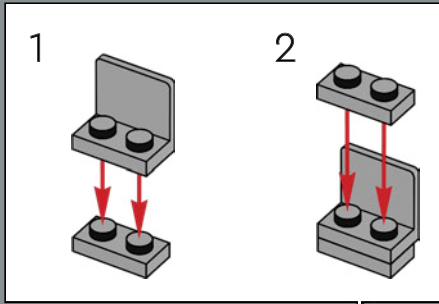

98

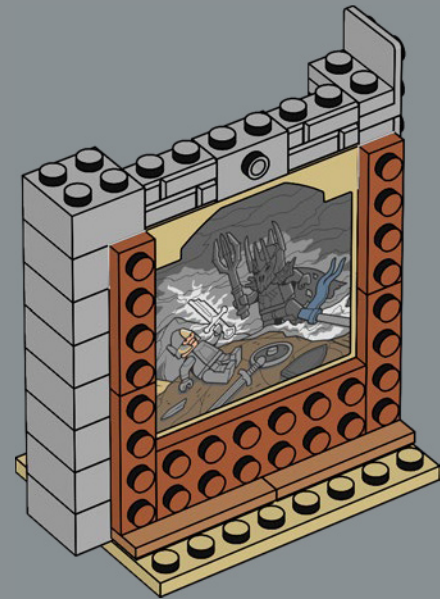

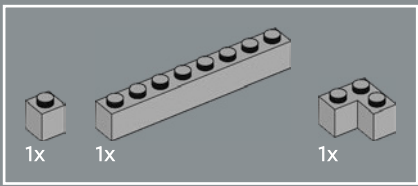

99

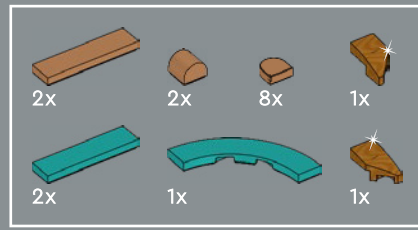
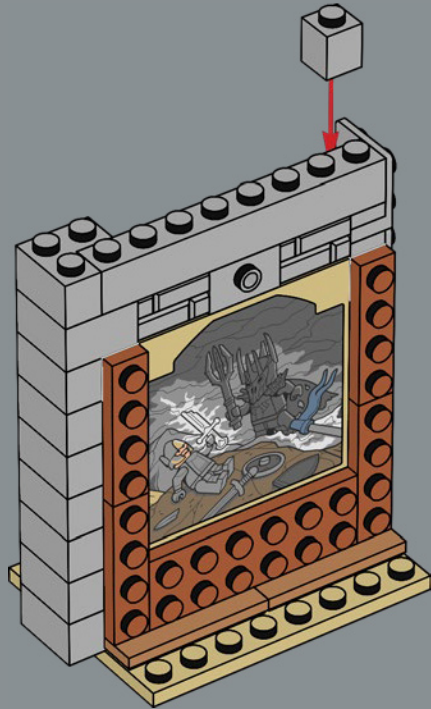

100

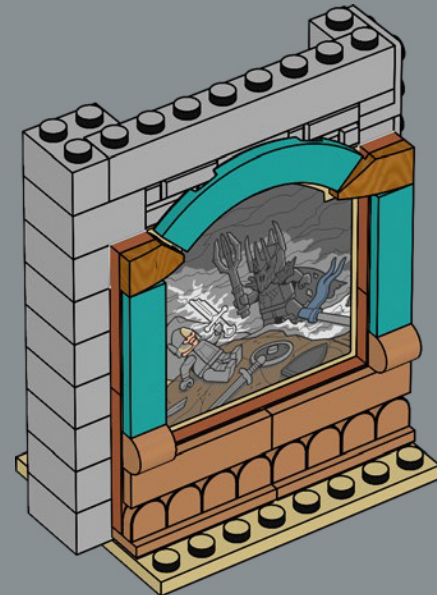

The Destruction of Sauron translated into the LEGO® universe features the newly designed Narsil hilt element and a gorgeous teal frame.



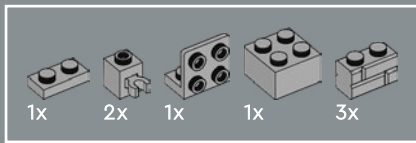

101

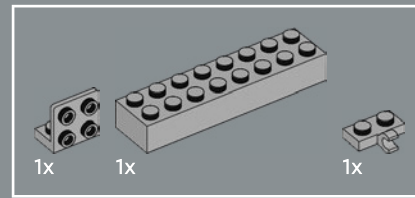
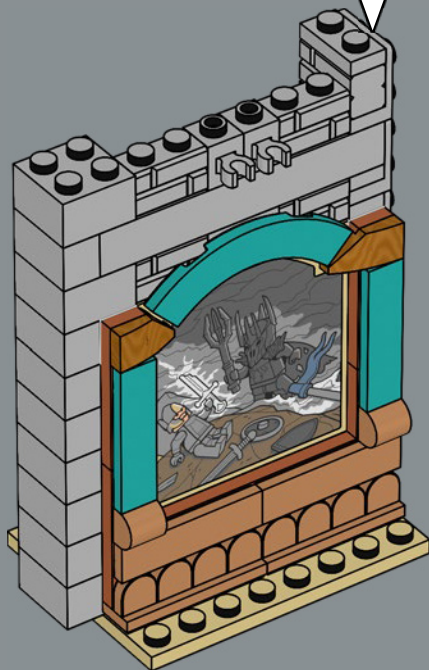
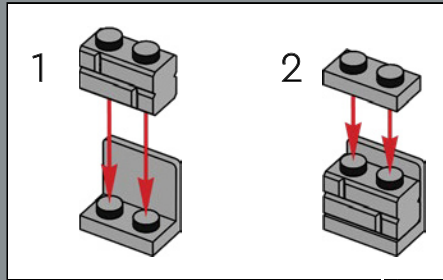

102

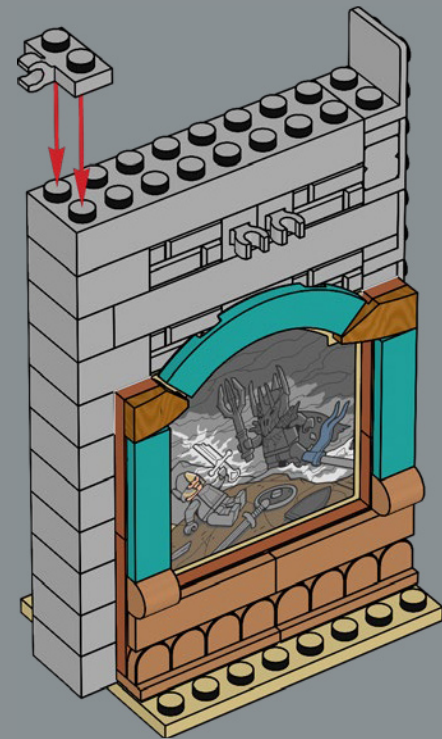

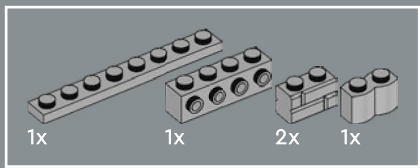

103

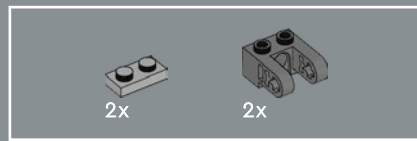
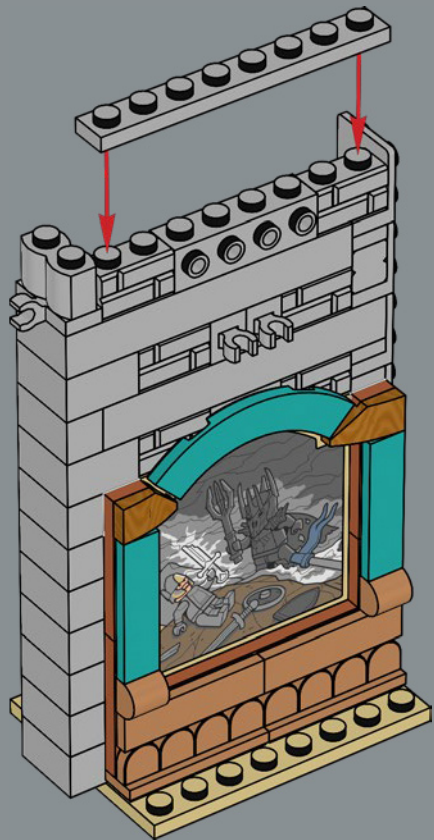

104

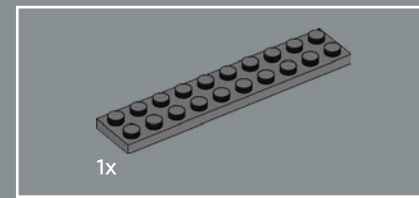
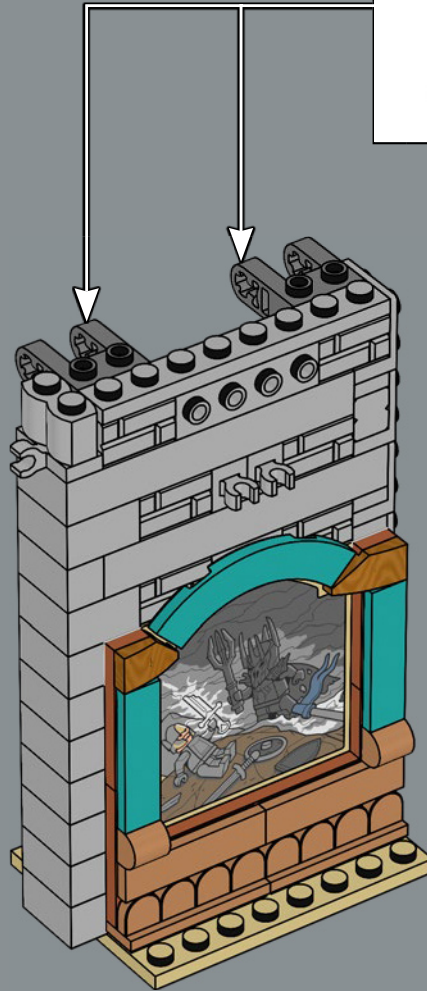
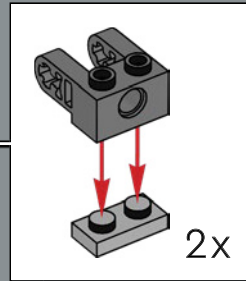

105







106



107

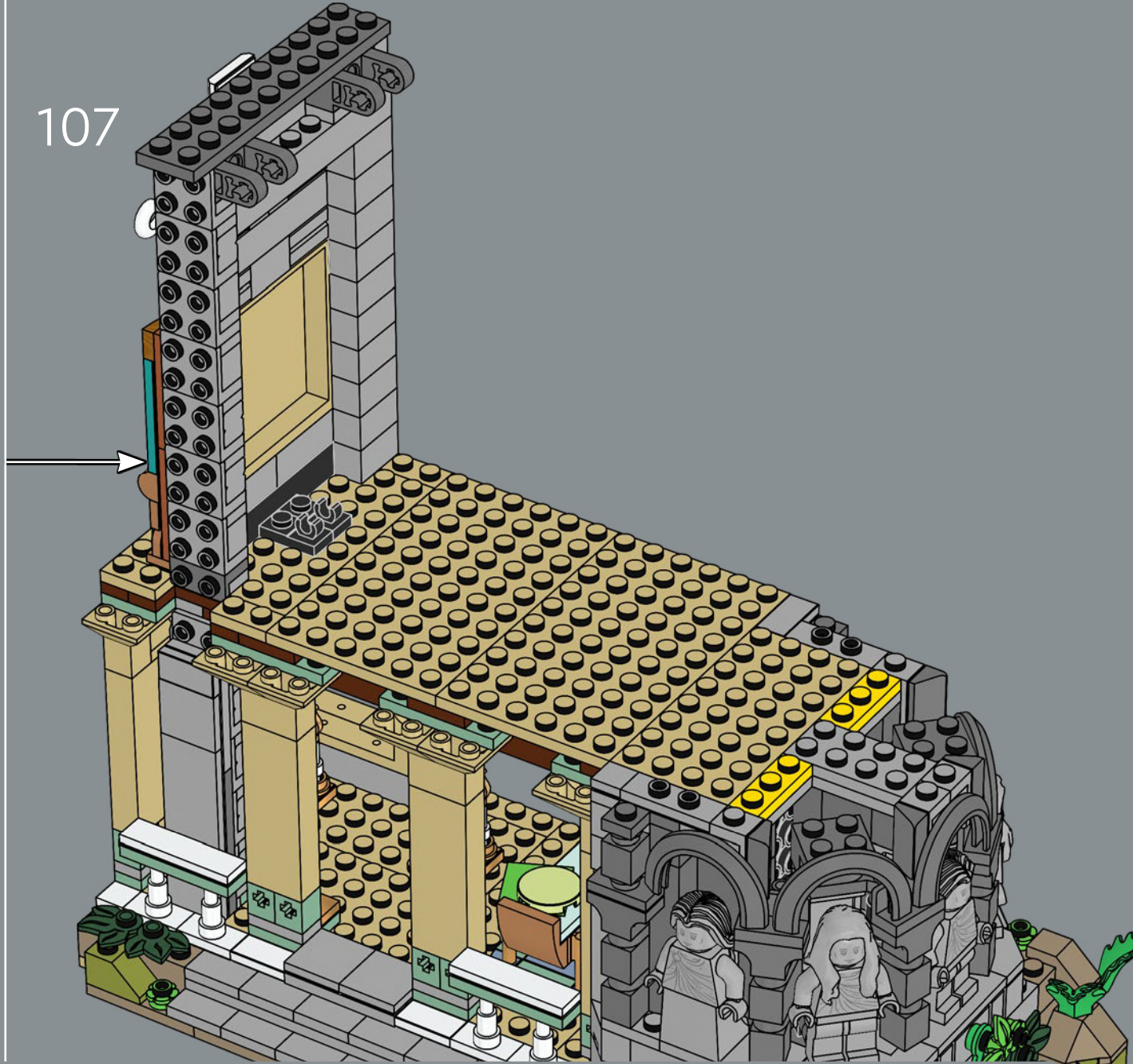

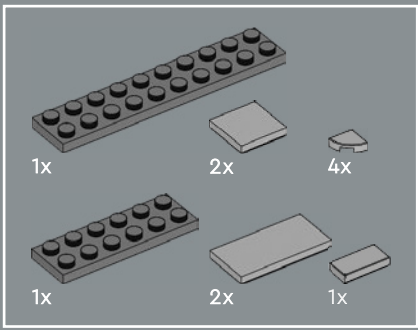

# 108

1

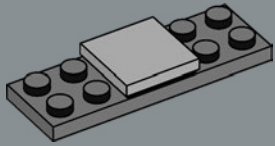

2

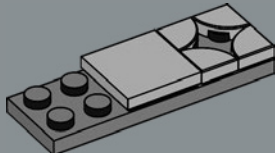

3

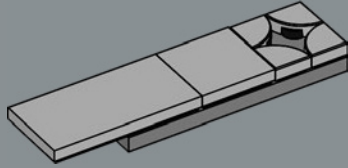

4

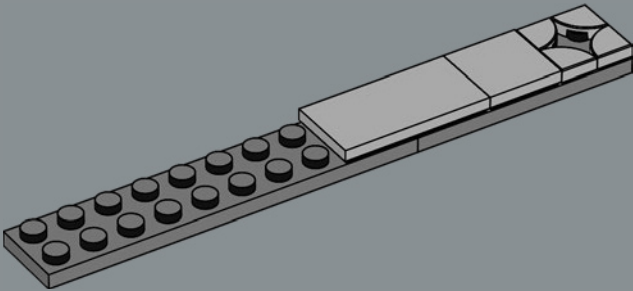

5

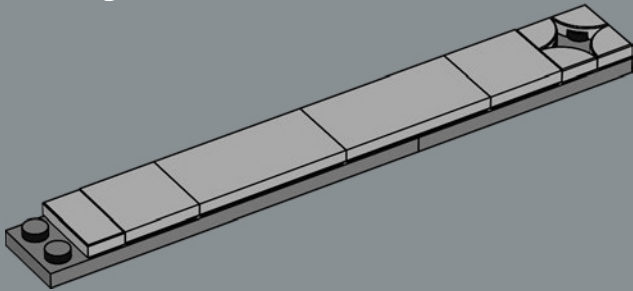

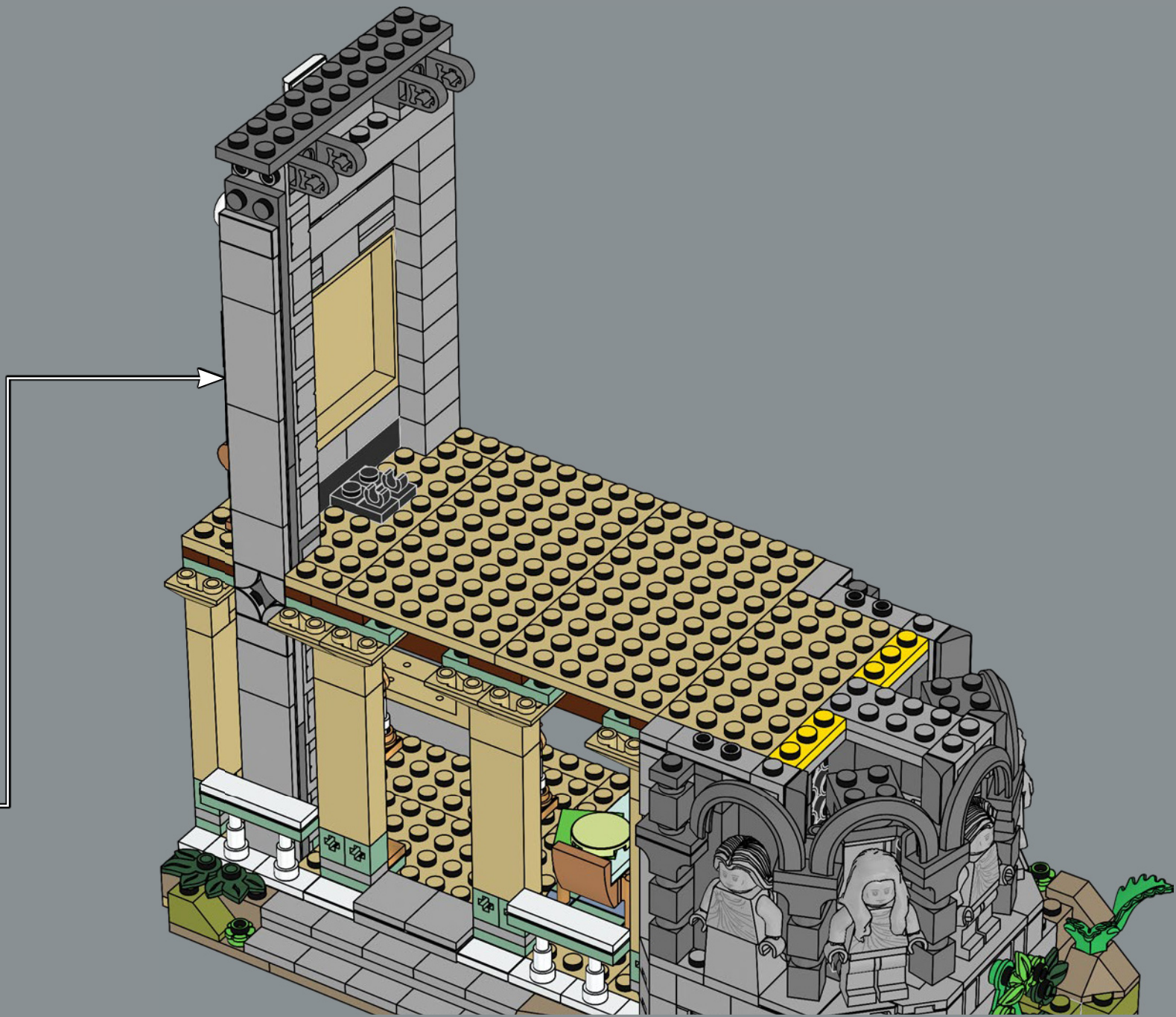

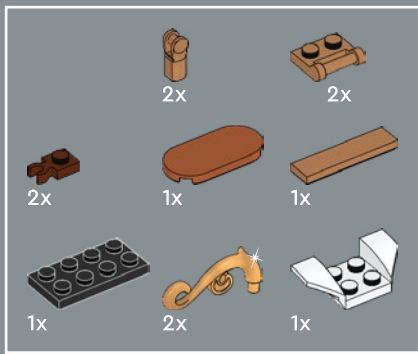

109

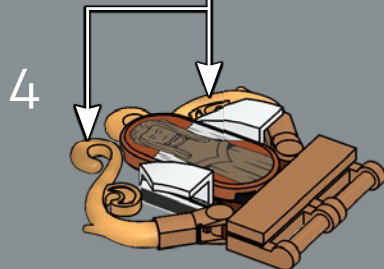
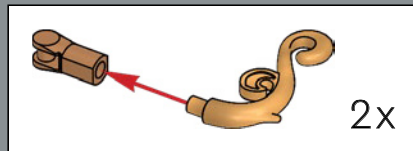
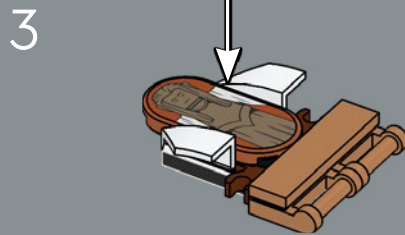
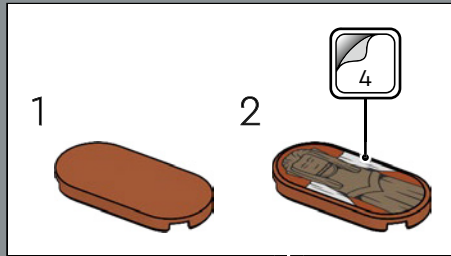
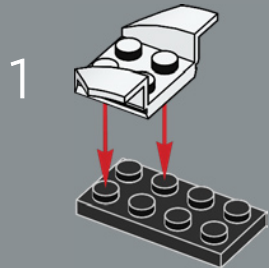

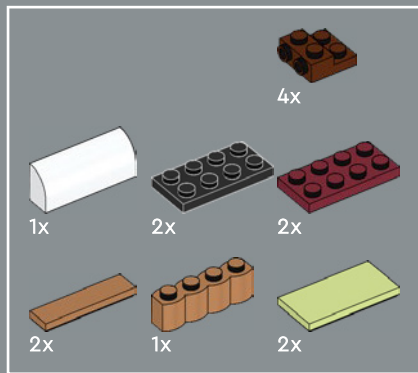

110

1

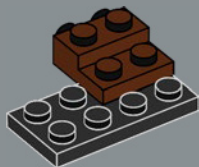

2

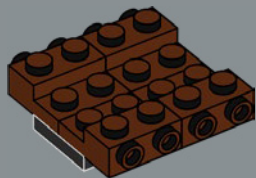

3

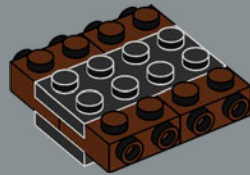

4



5

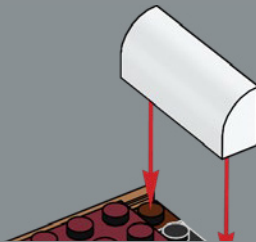

6

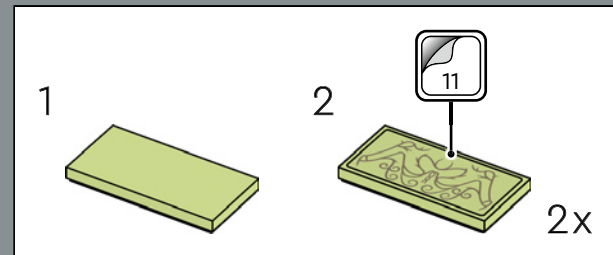
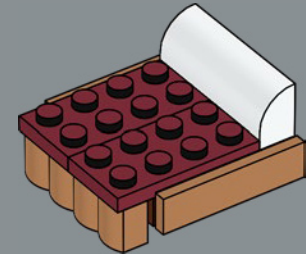

7

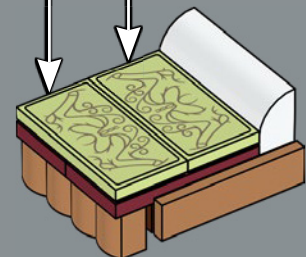

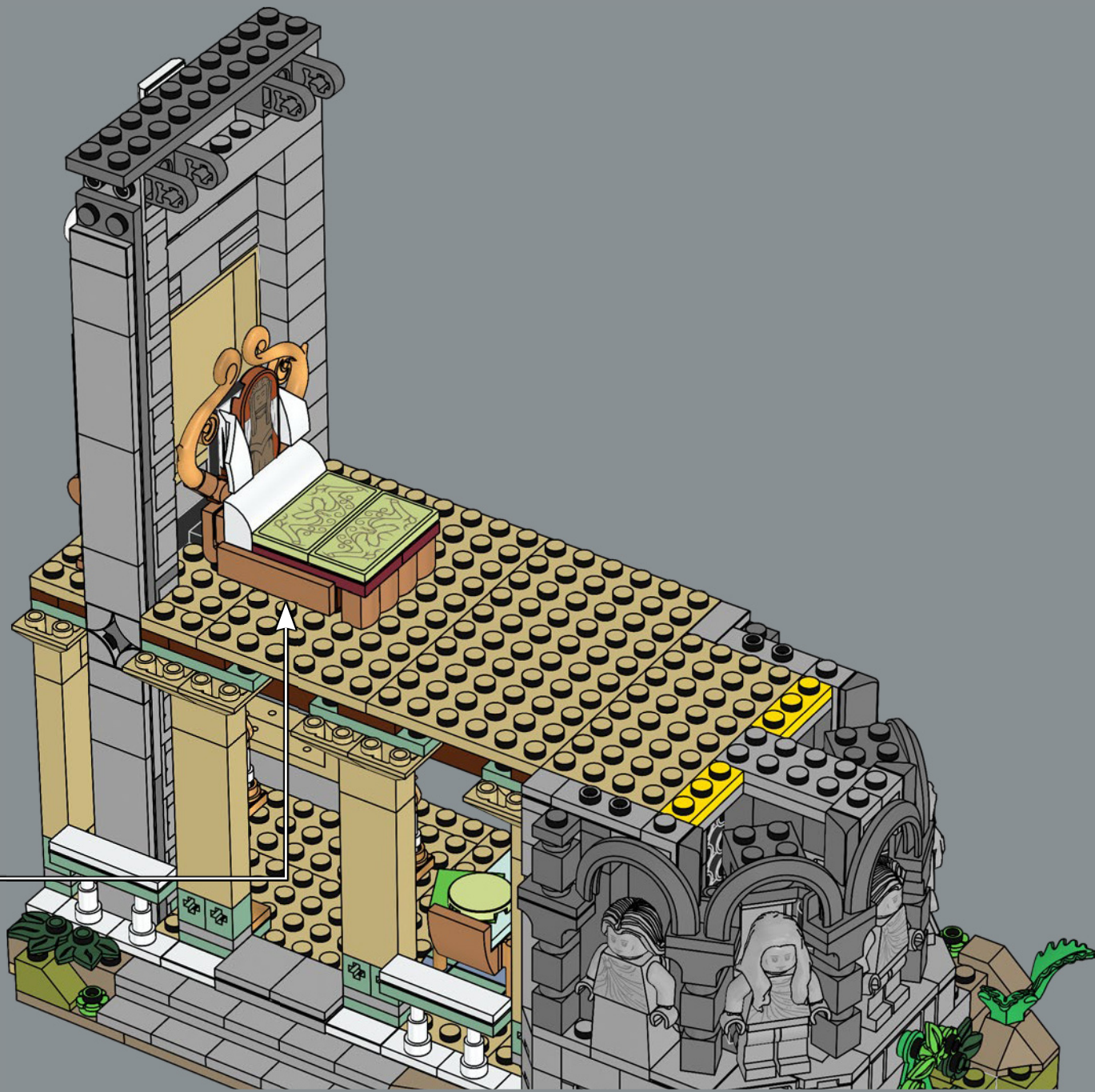



111

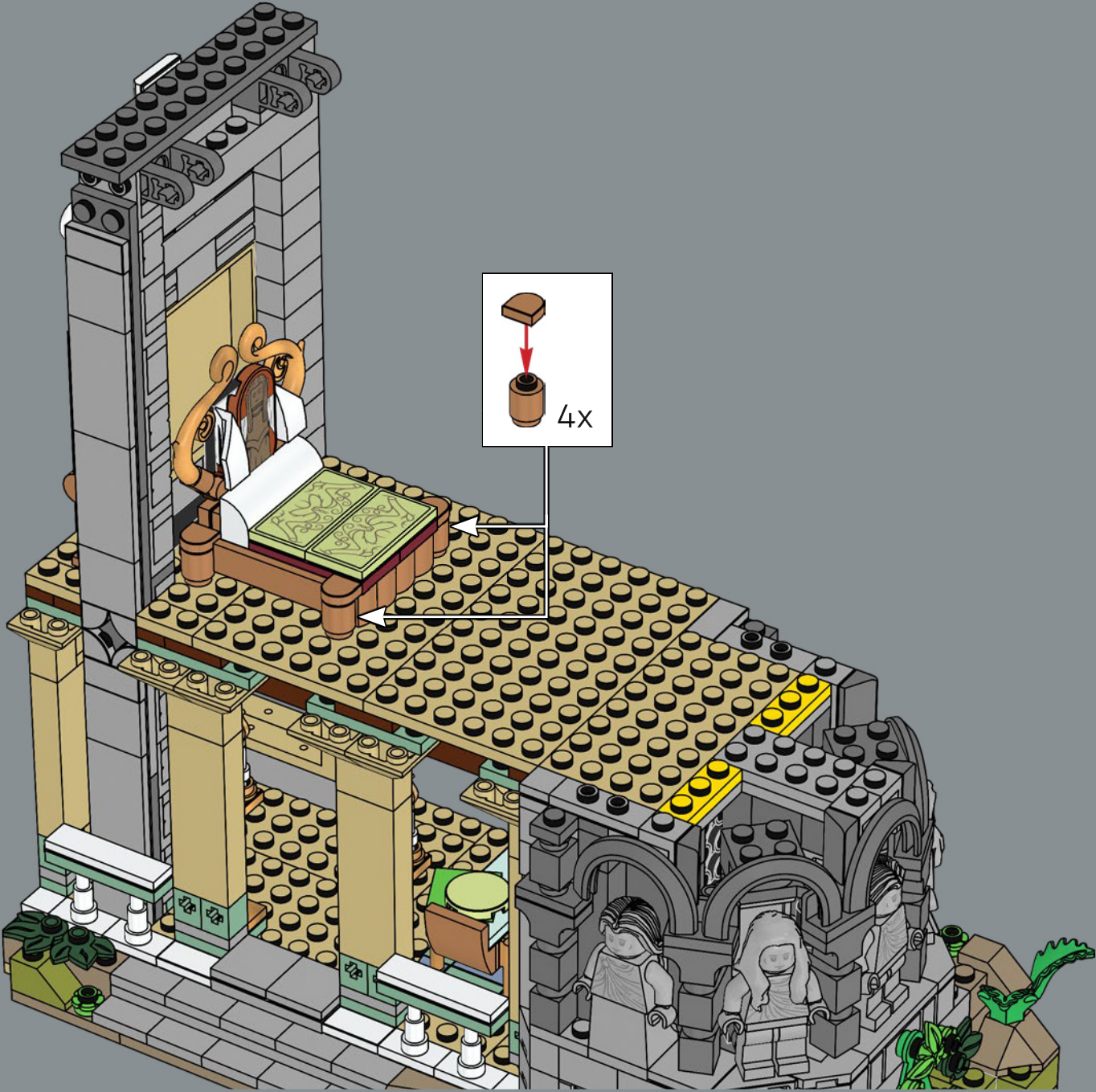

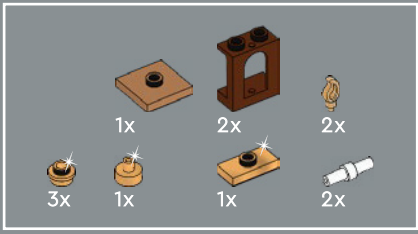

112

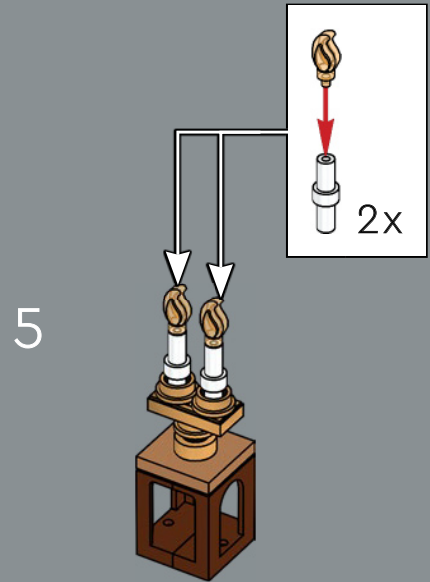
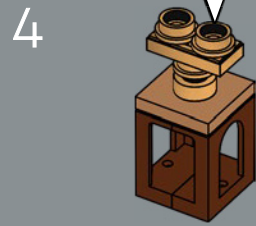
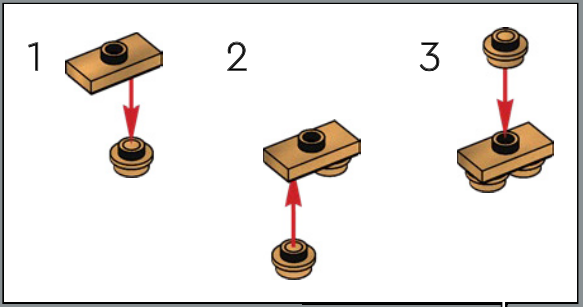
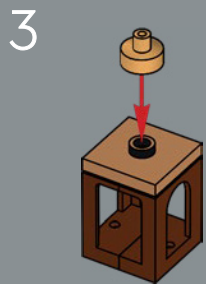
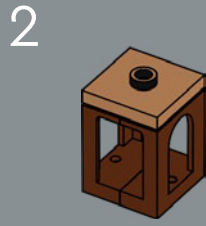
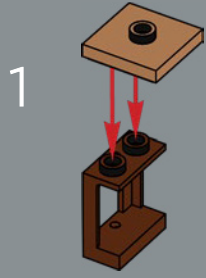



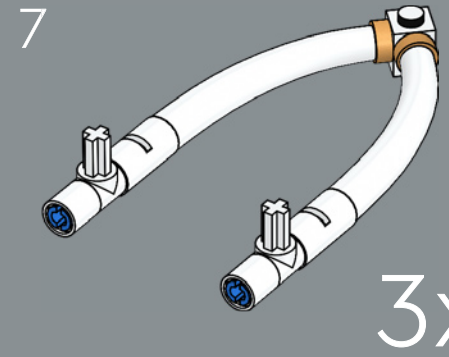
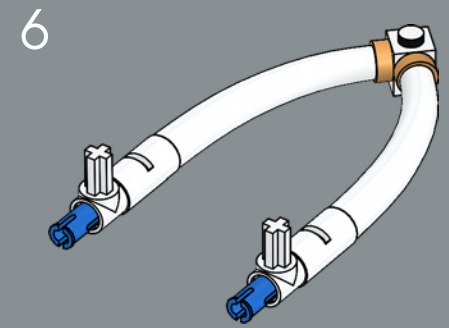
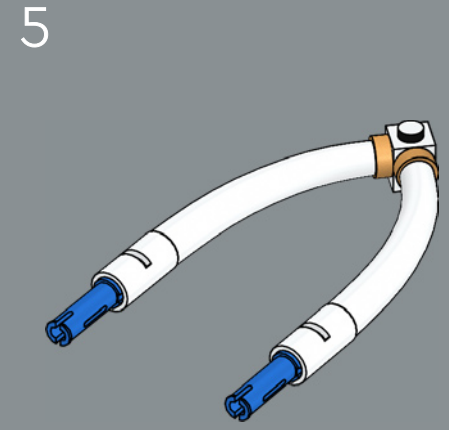
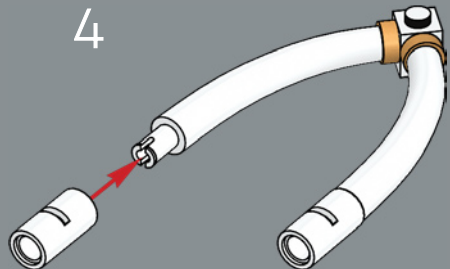
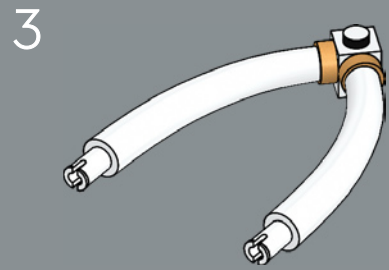
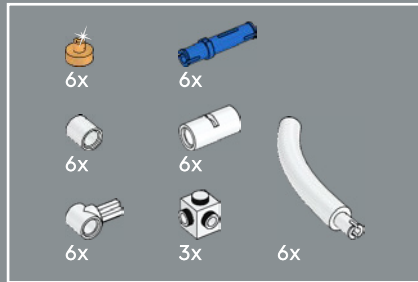
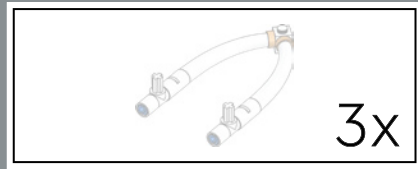

113





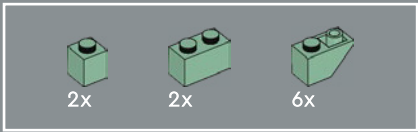

114



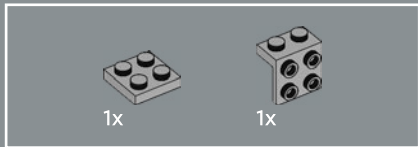
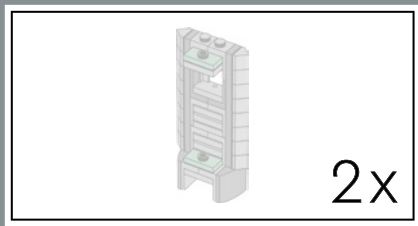

115

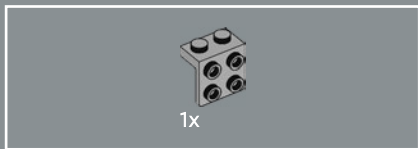
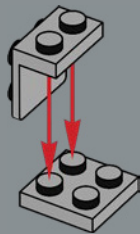

116

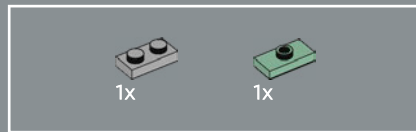
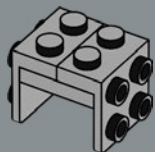

117

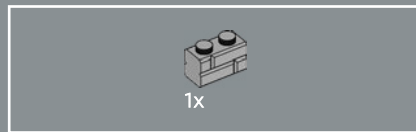
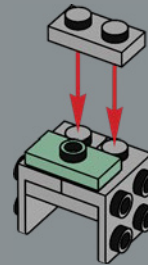

118

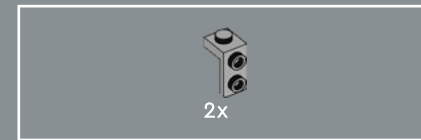
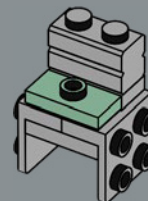

119

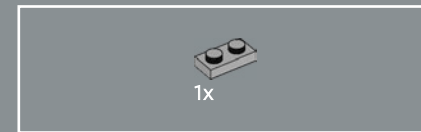
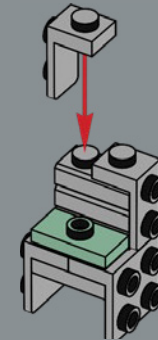

120

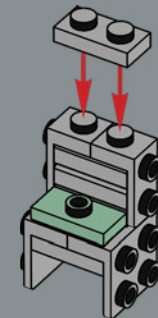

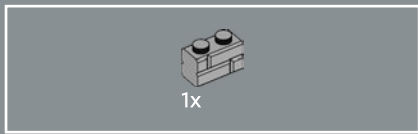

121

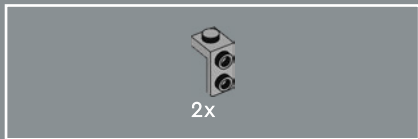
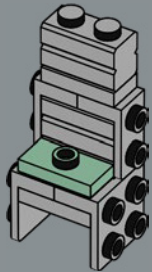

122

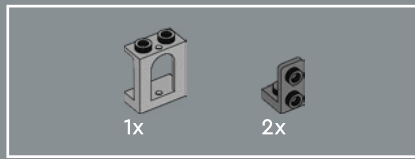
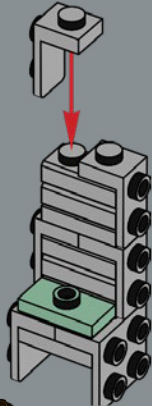

123

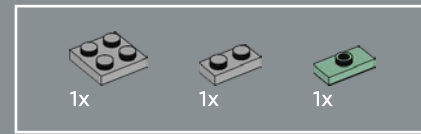
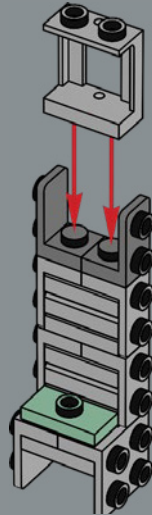

124

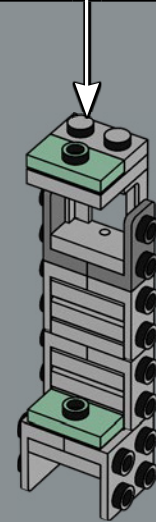
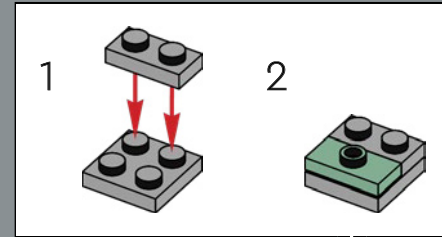



2x

125

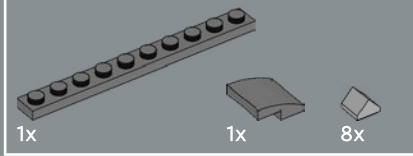
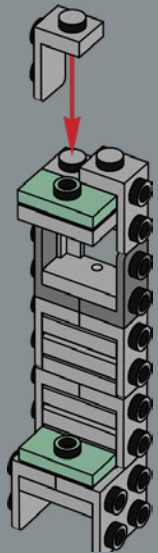

126

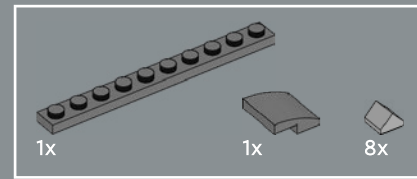
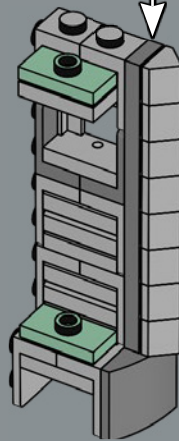
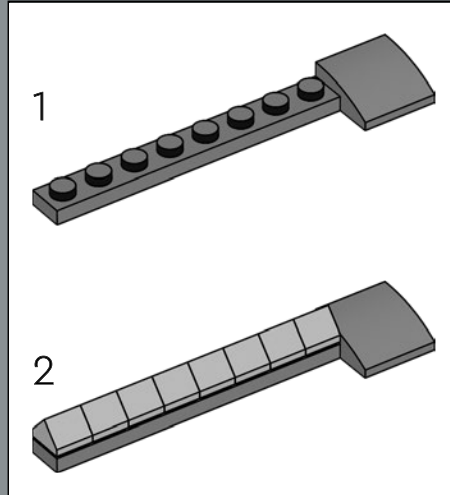

127

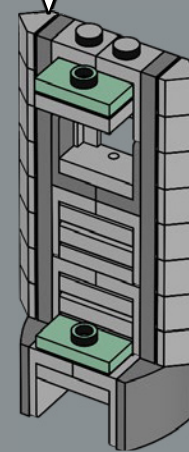
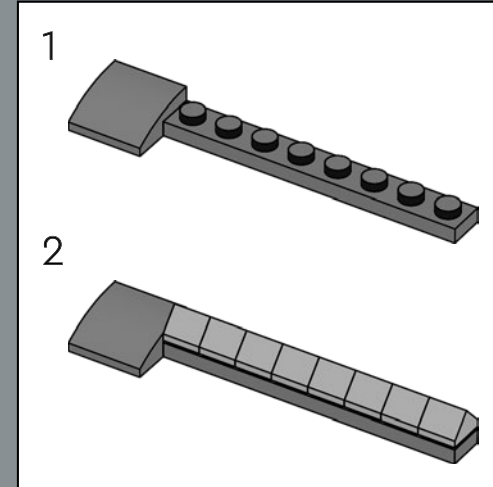

2x

128



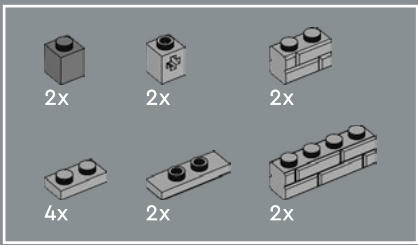

129

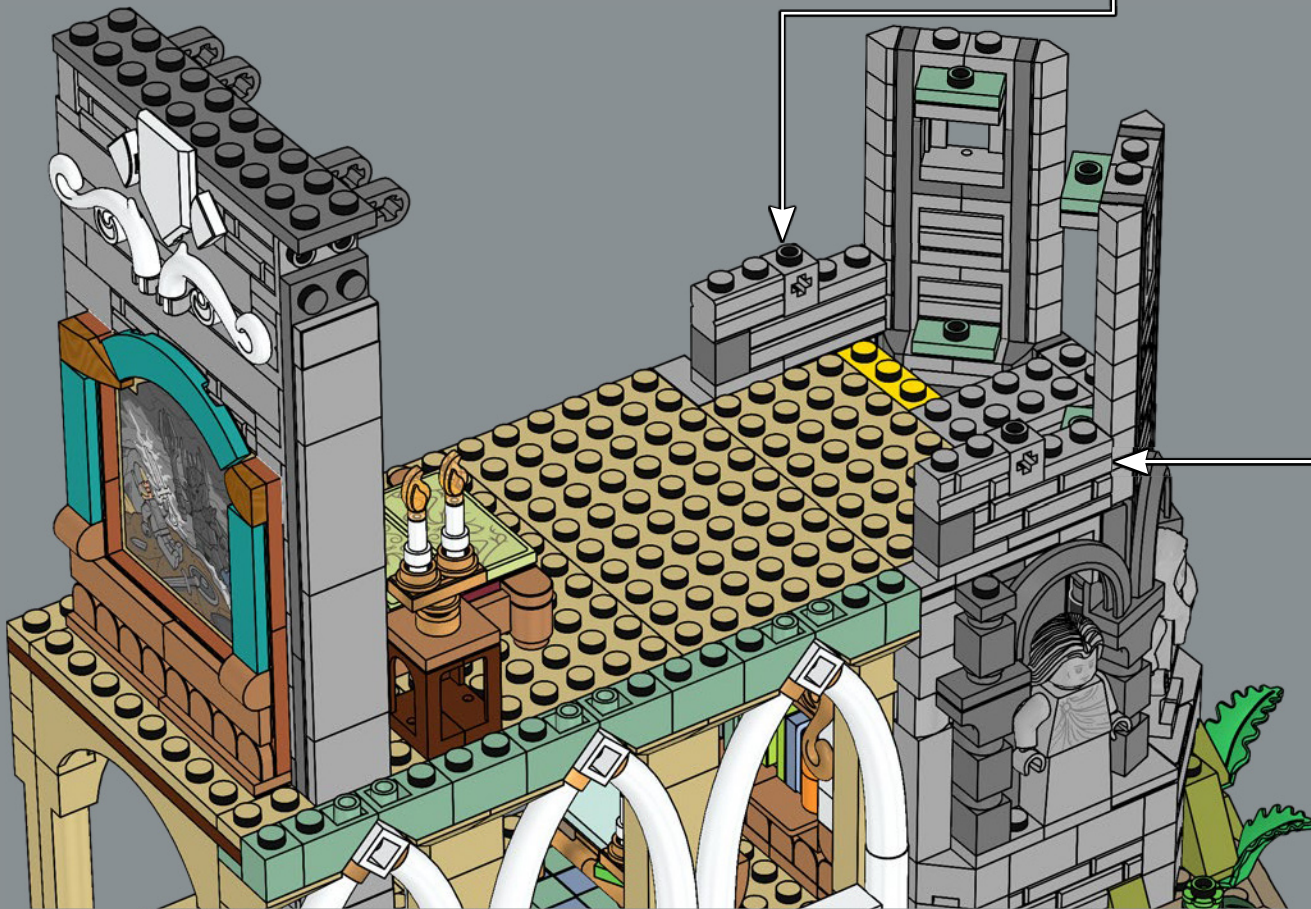
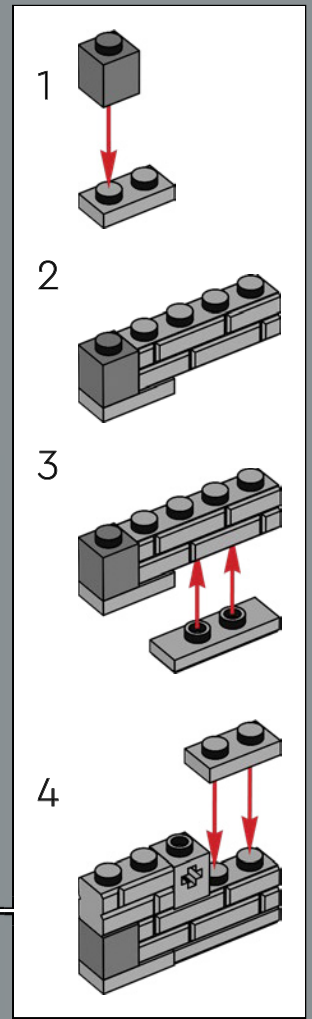
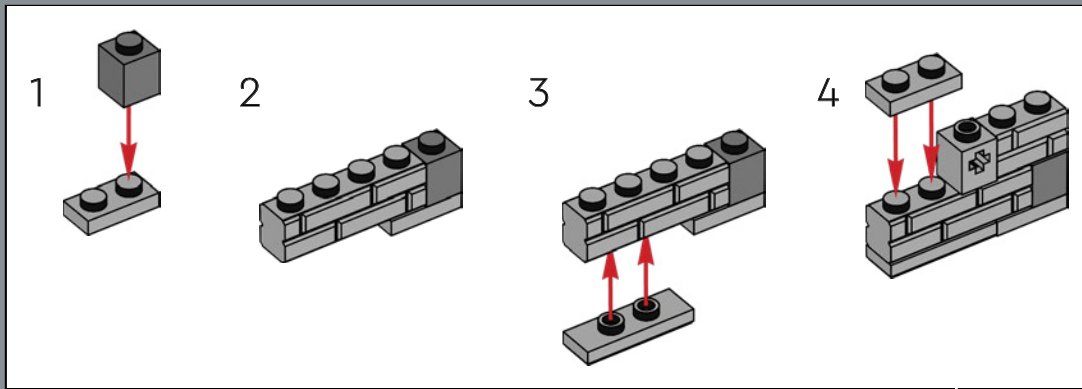



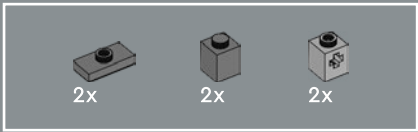

130

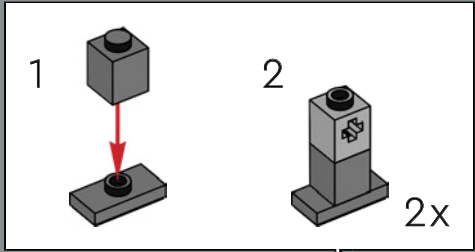

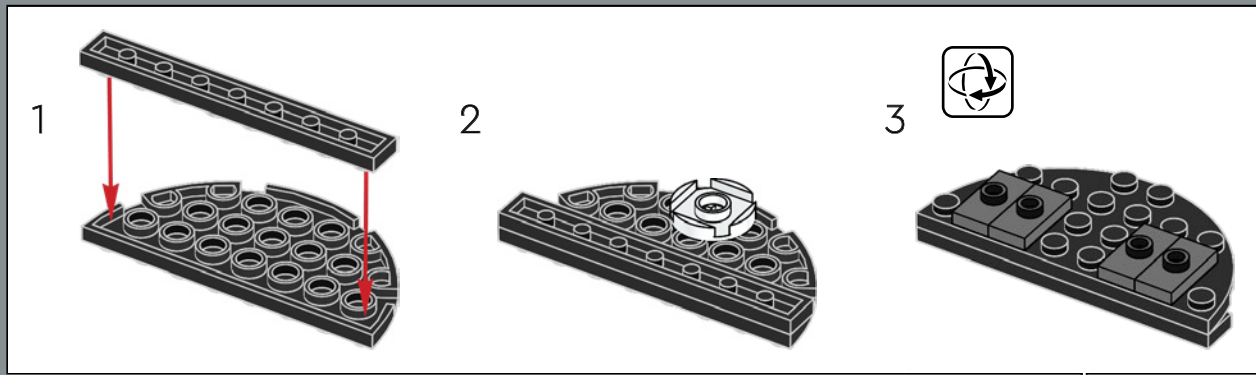
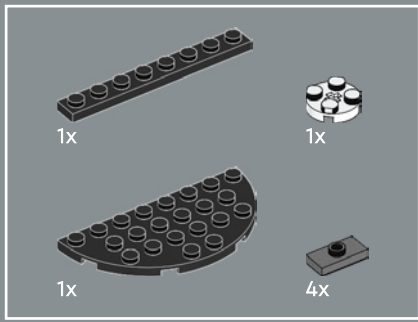

131



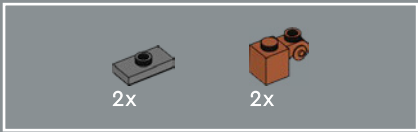

132

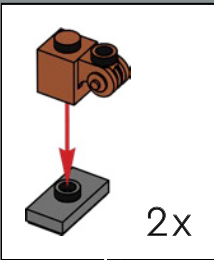

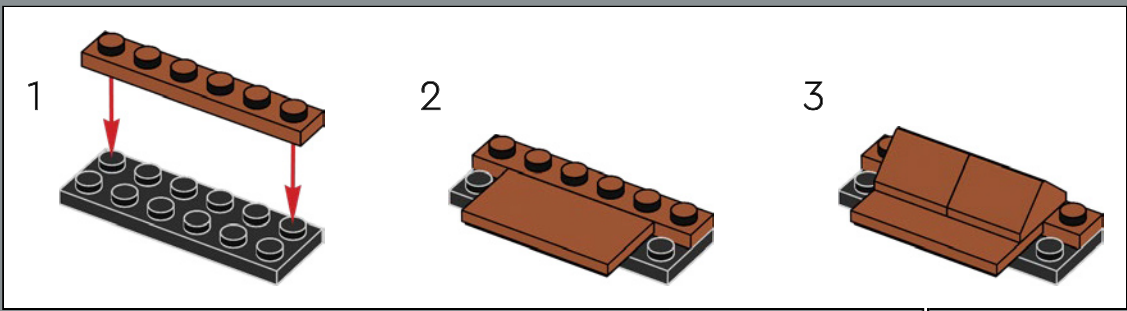
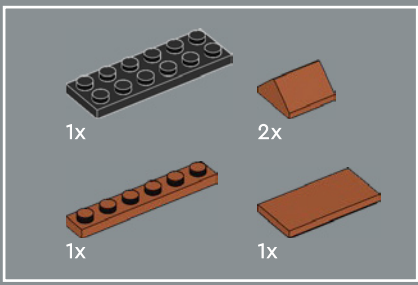

133



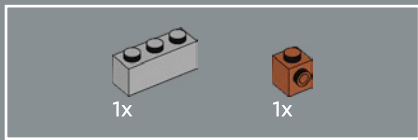

134

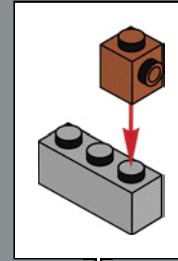

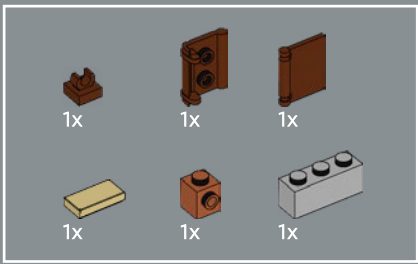

Not only is this a great location to write a book, but this desk also provides critical structural stability for the roof and tower that will be attached later.

# 135

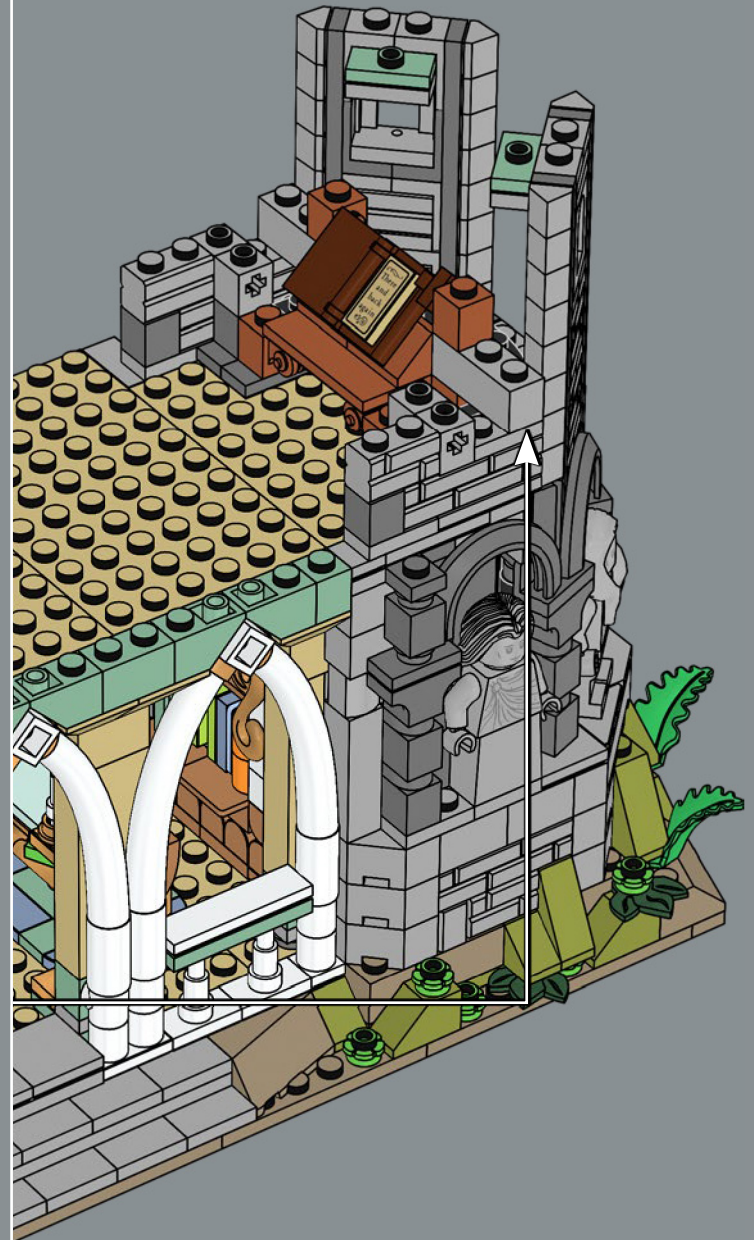
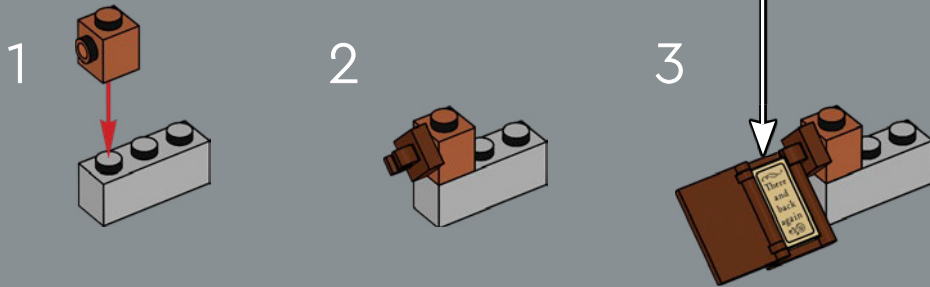
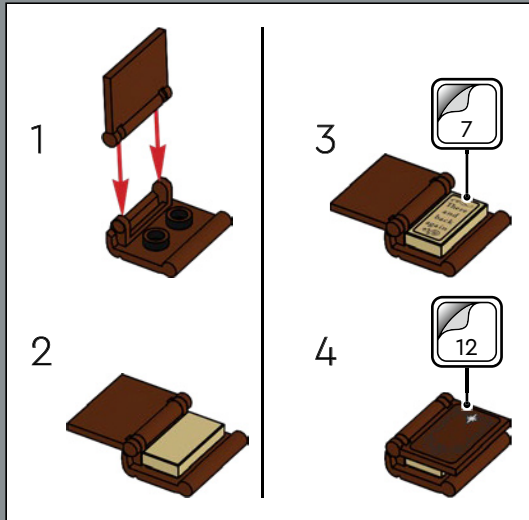

-  2x
-  1x
-  2x
-  1x
-  2x
-  2x
-  1x

136

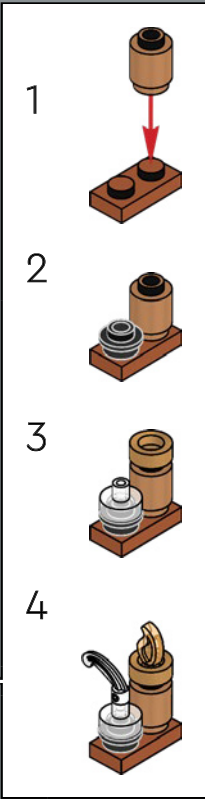
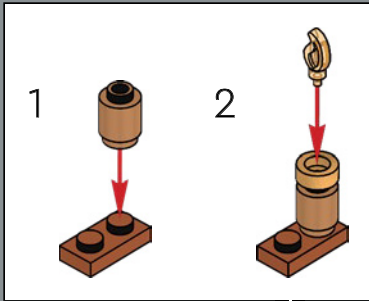

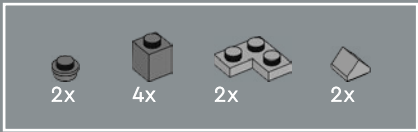

137

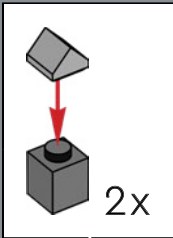





This is the first time in a LEGO® model we get to meet 111+-year-old Bilbo. Don't let him see the Ring or he might get a bit too excited!

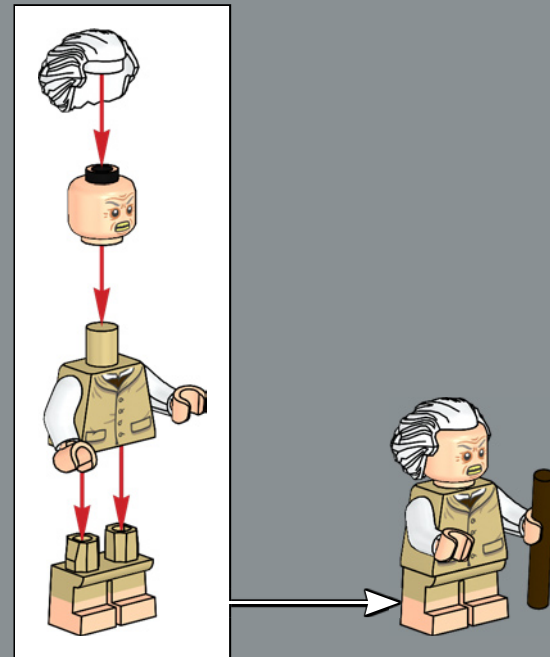

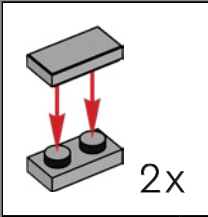
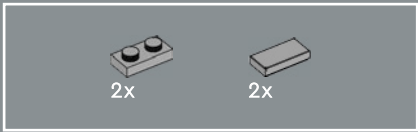

138

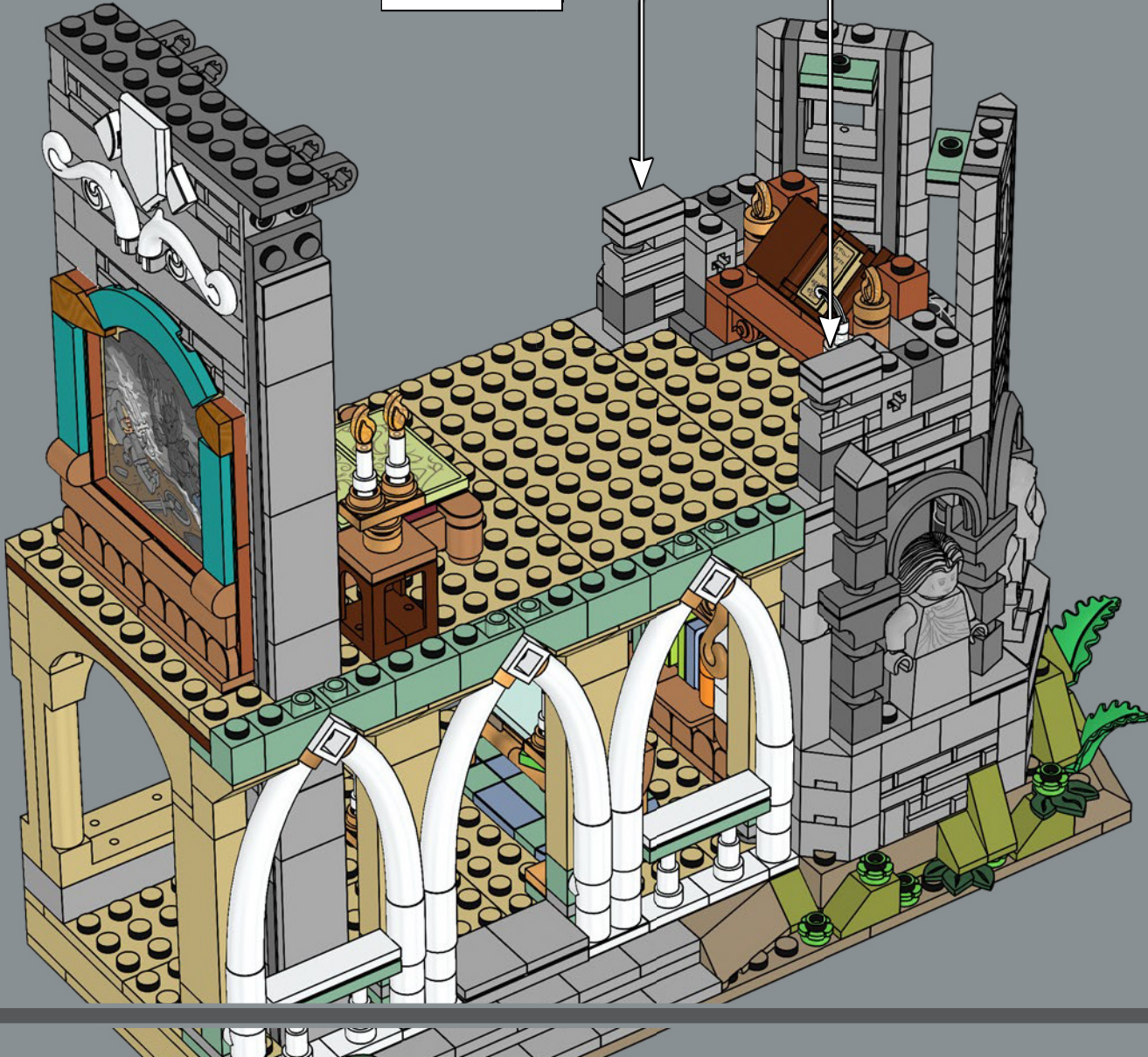

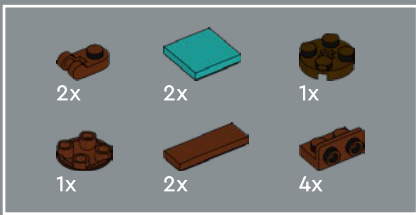

139

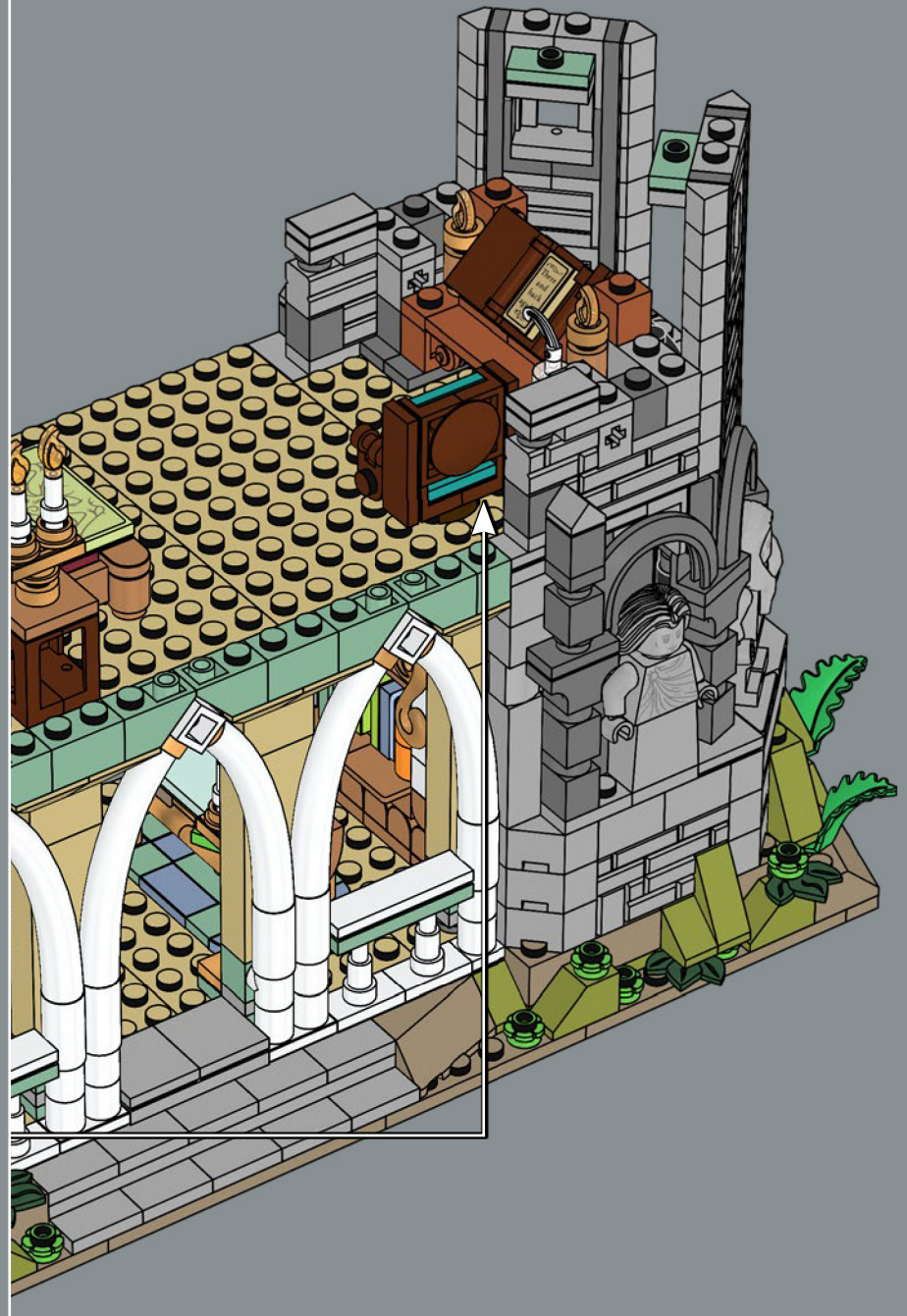
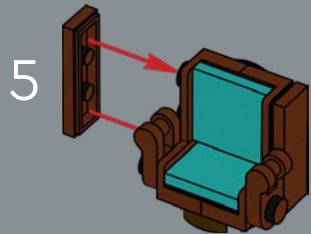
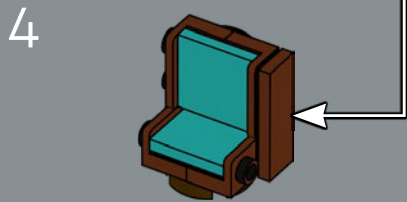
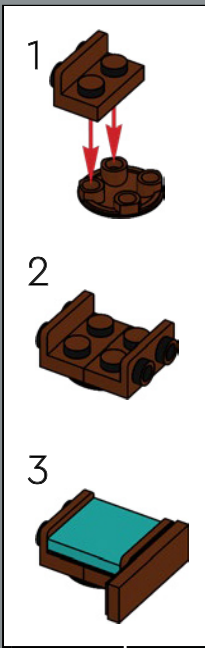
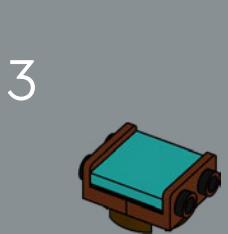
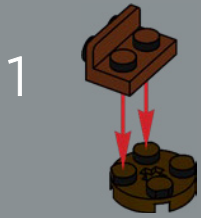

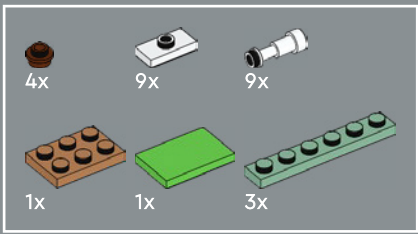

140

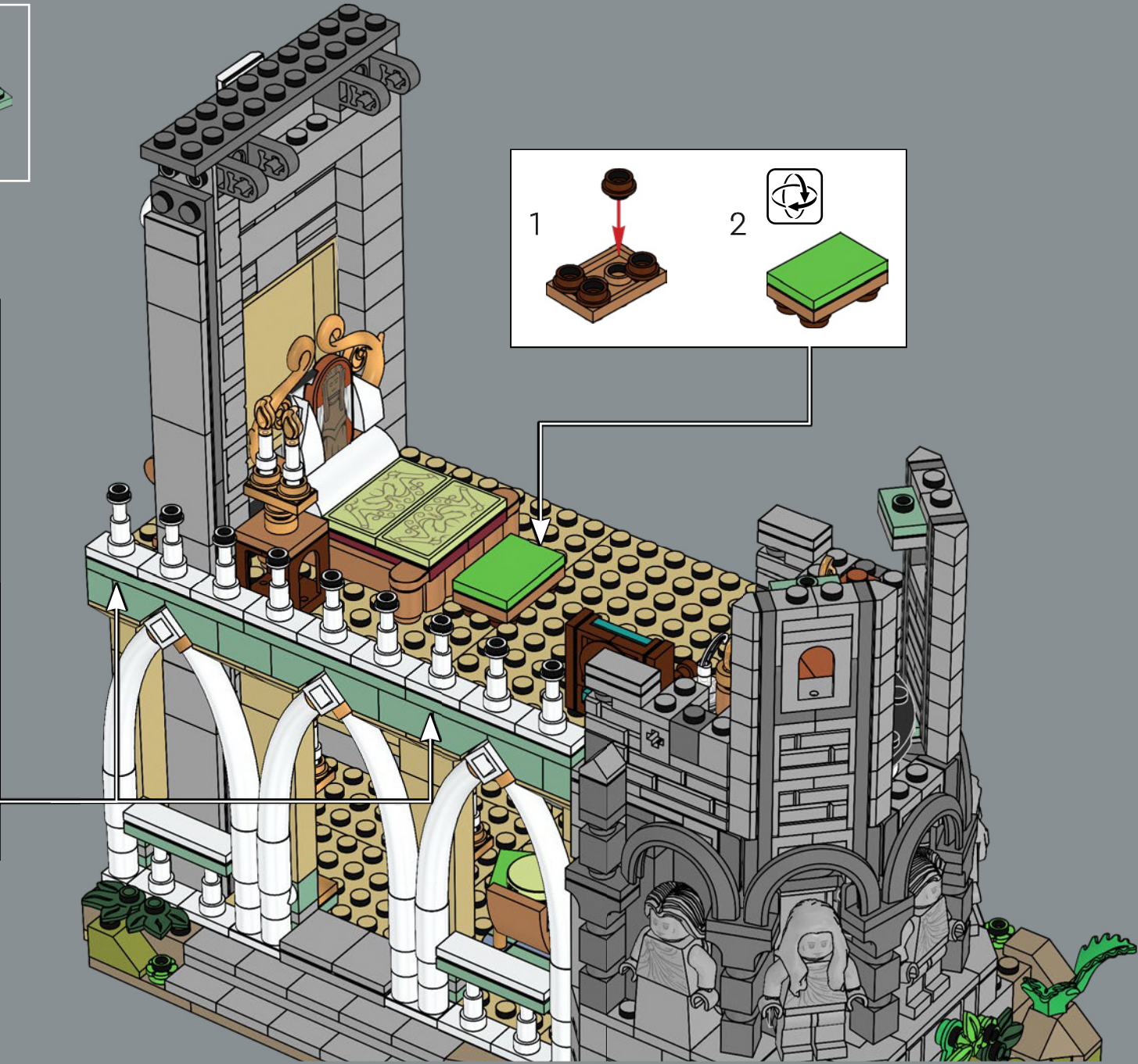
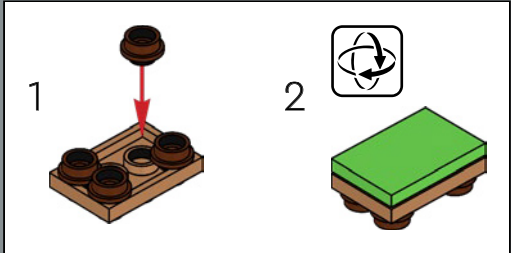
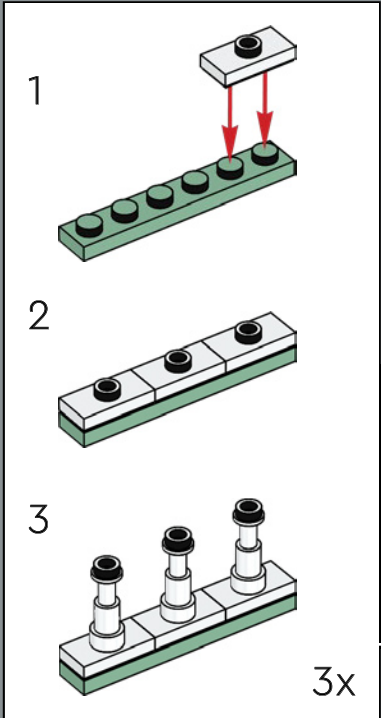

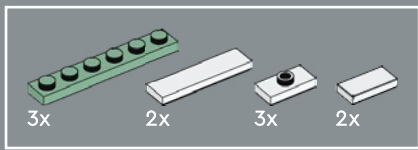

141

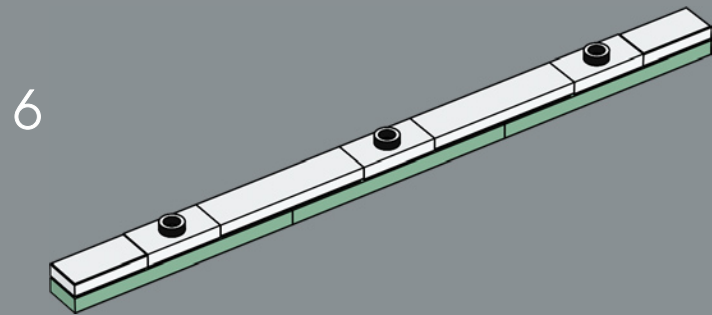
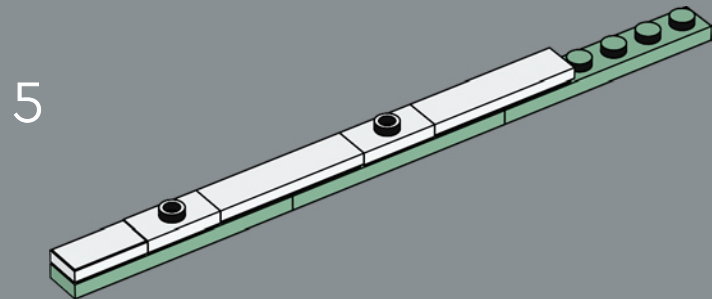
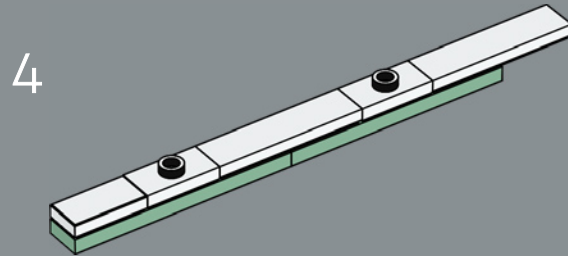
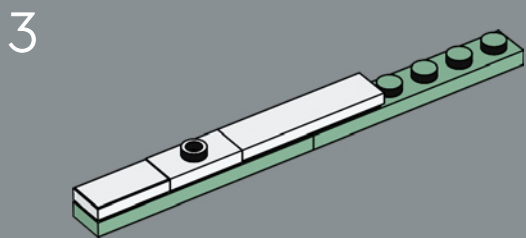
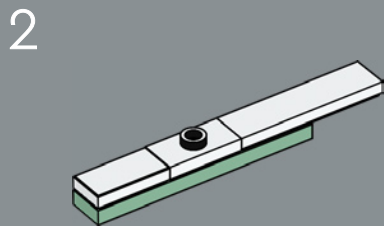
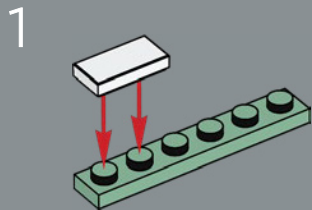



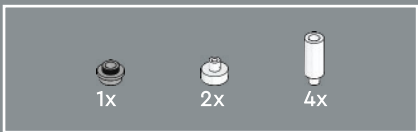

142

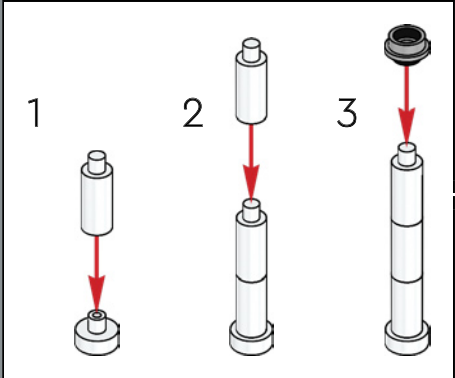

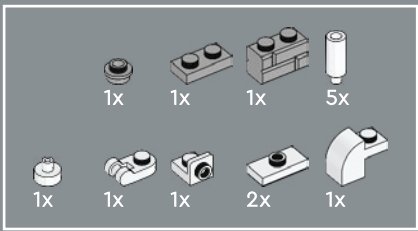

# 143

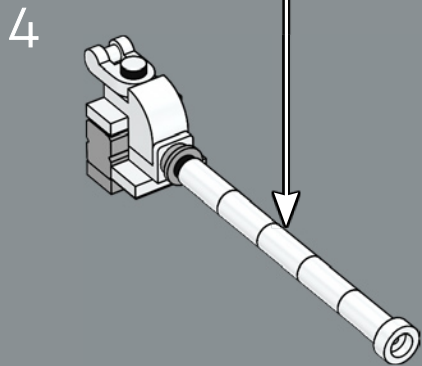
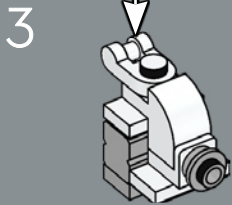
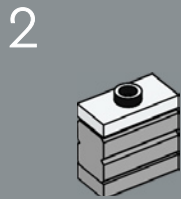
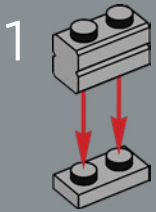
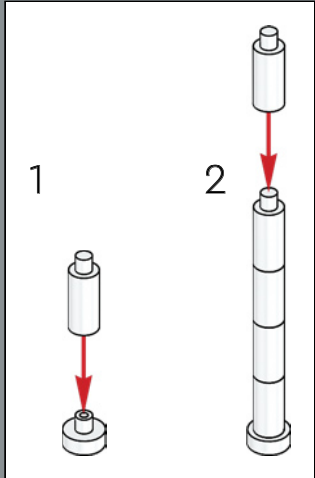
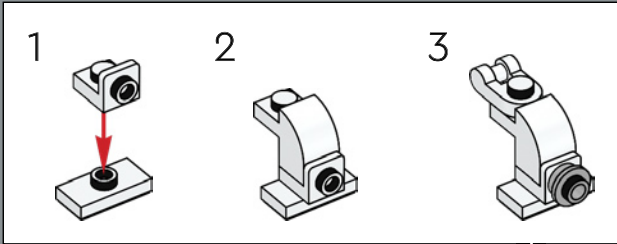





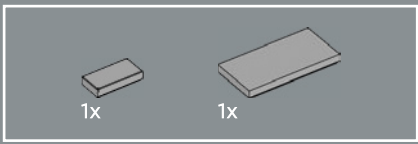

144



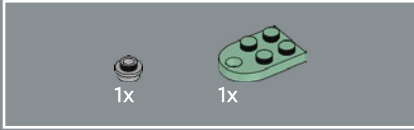
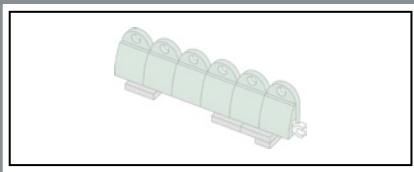

145

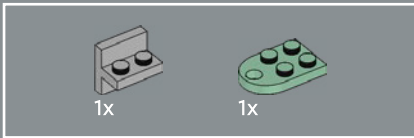
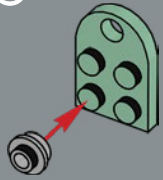

146

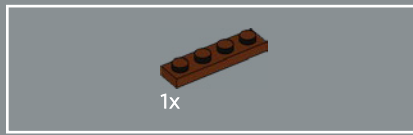
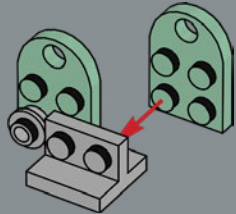

147

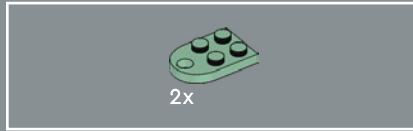
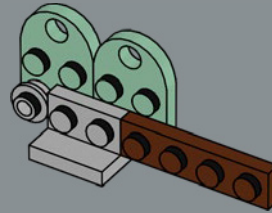

148

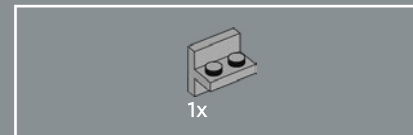
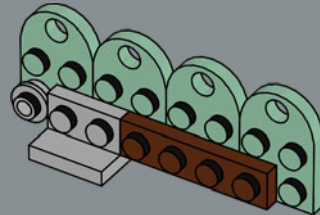

149

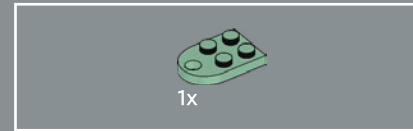
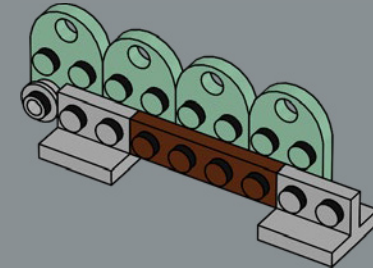

150

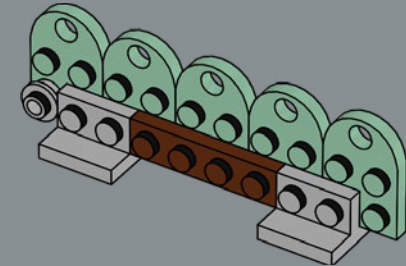

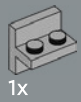

1x

151

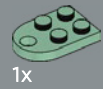
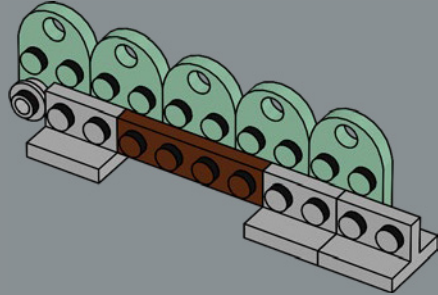

1x



1x

152

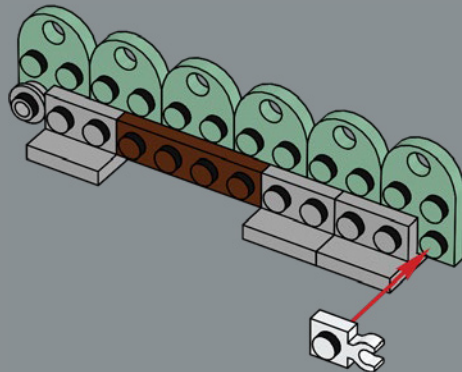

6x

153

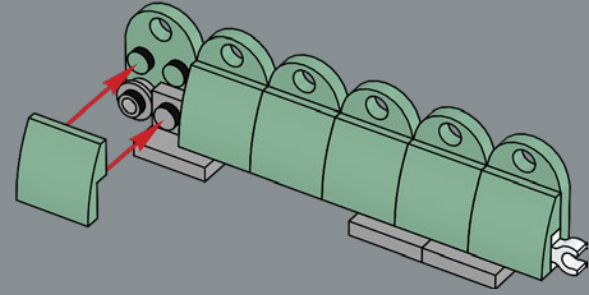

1x

154

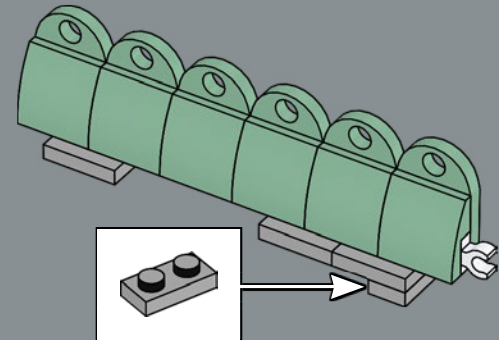

155

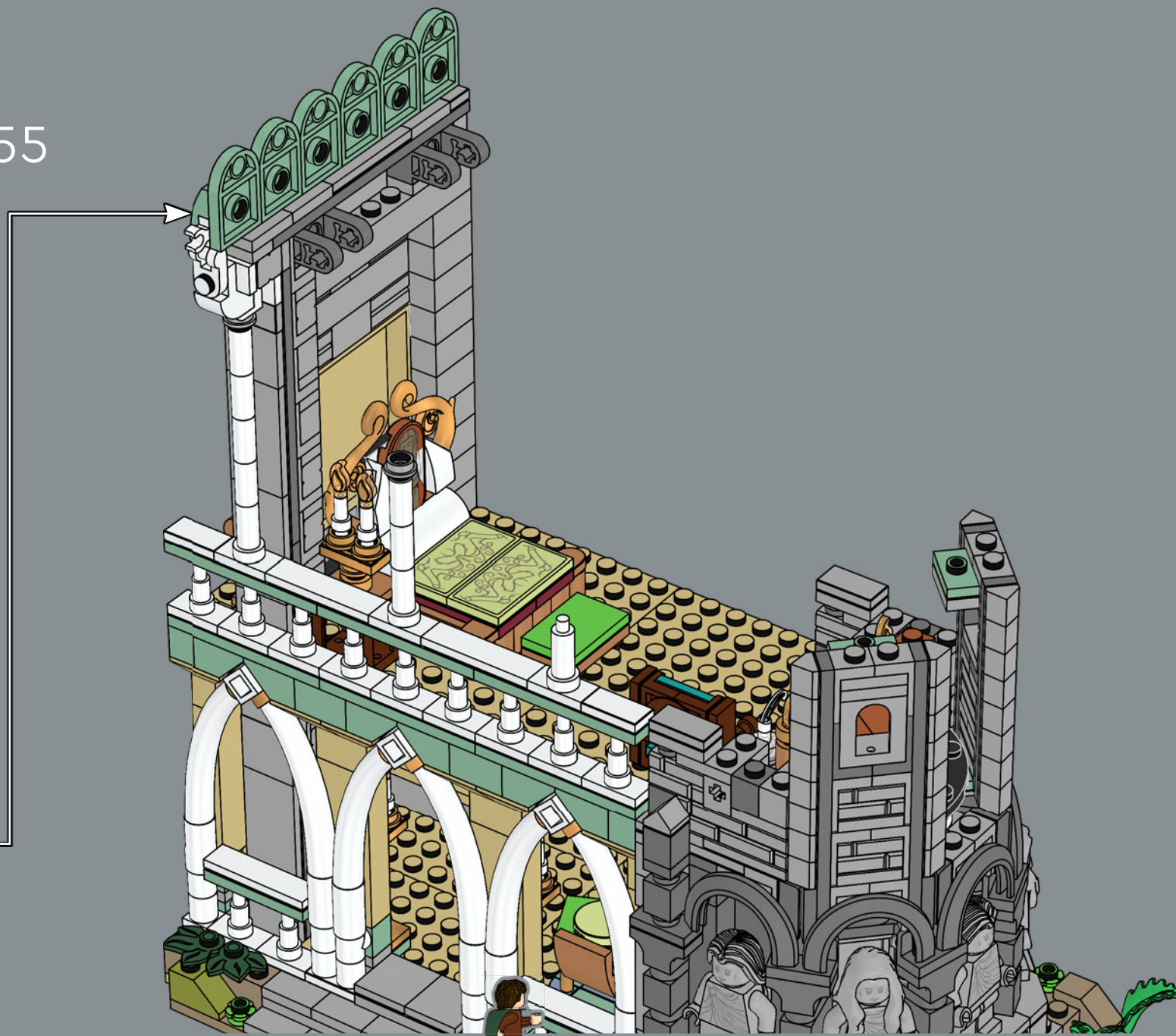

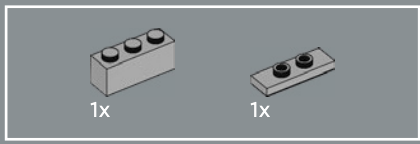

156

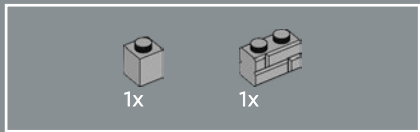
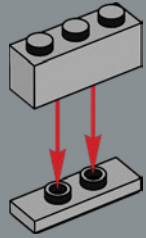

157

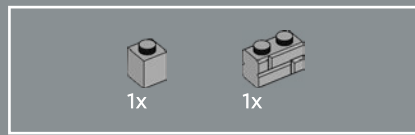
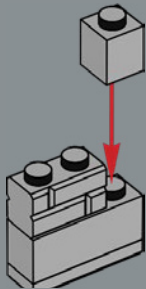

158

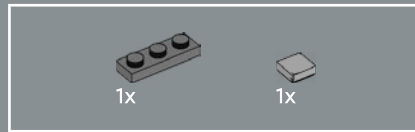
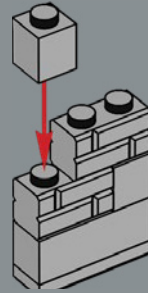

159

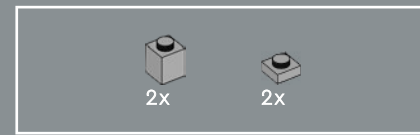
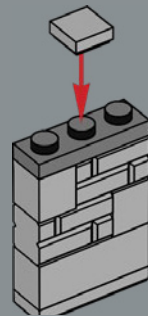

160

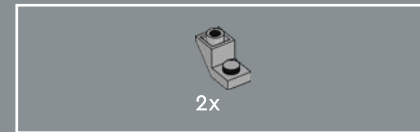
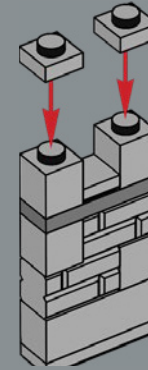

161

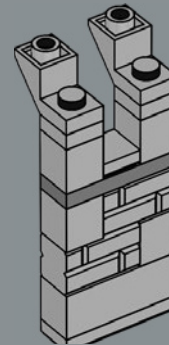

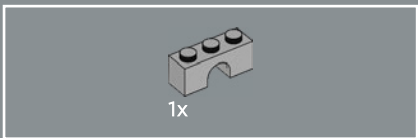

162

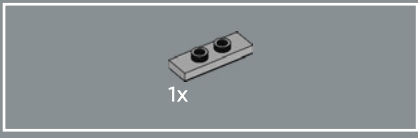
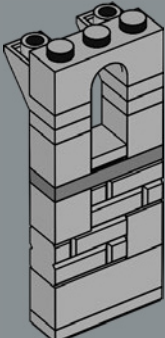

163

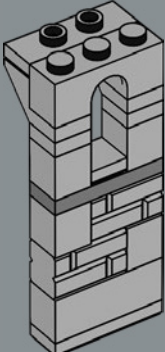

164



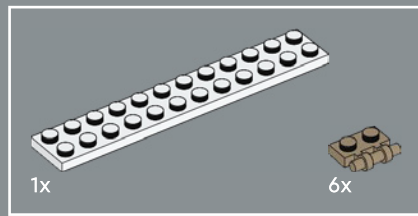

165

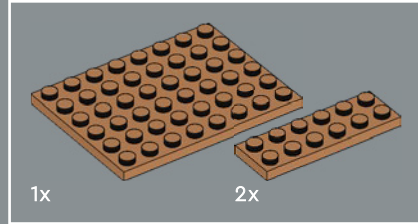
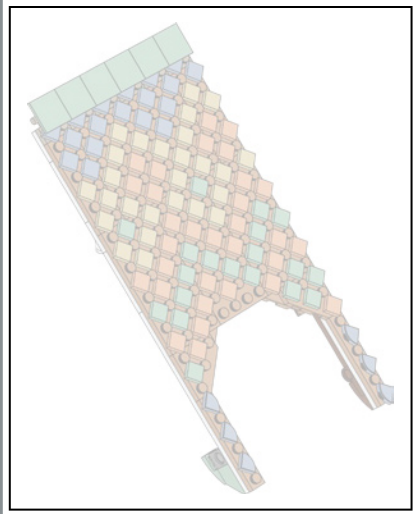
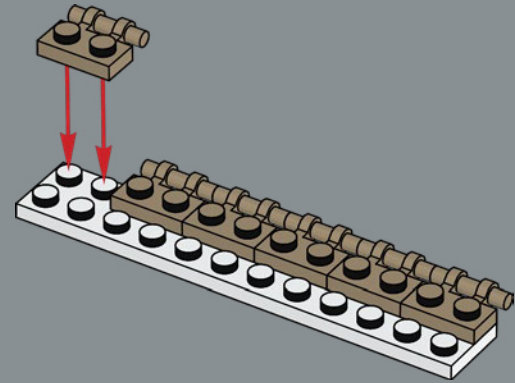

166

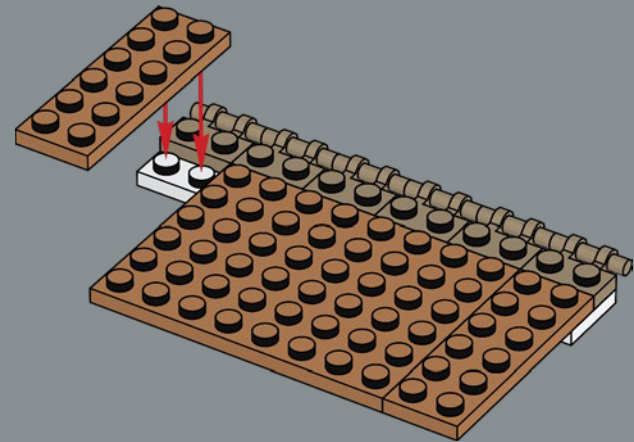



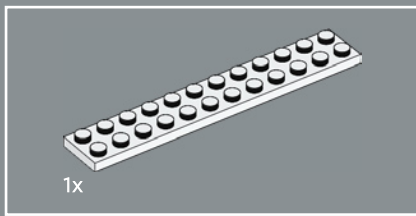

167

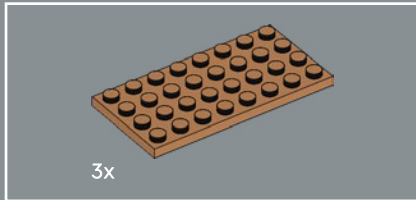
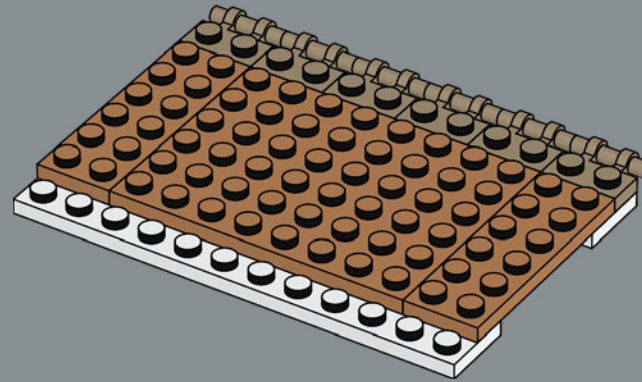

168



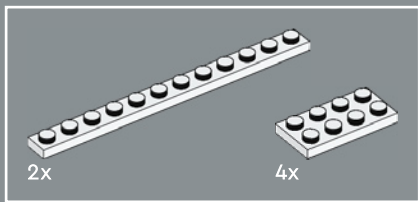

169

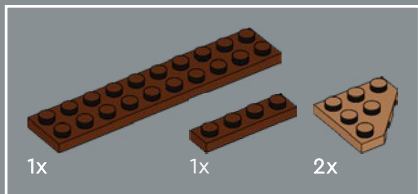
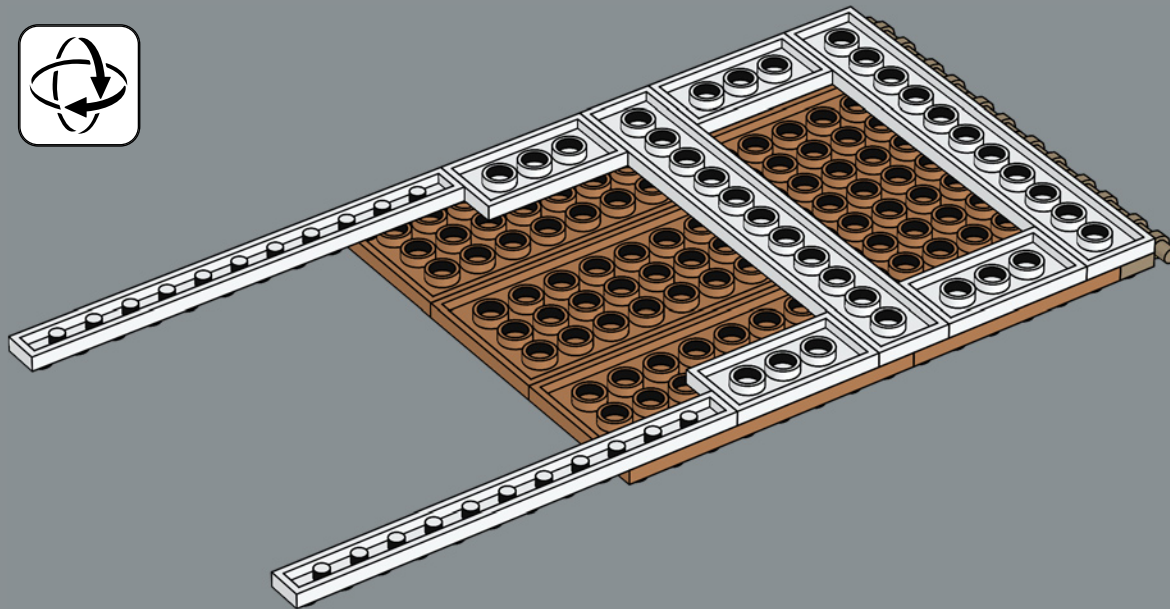

170

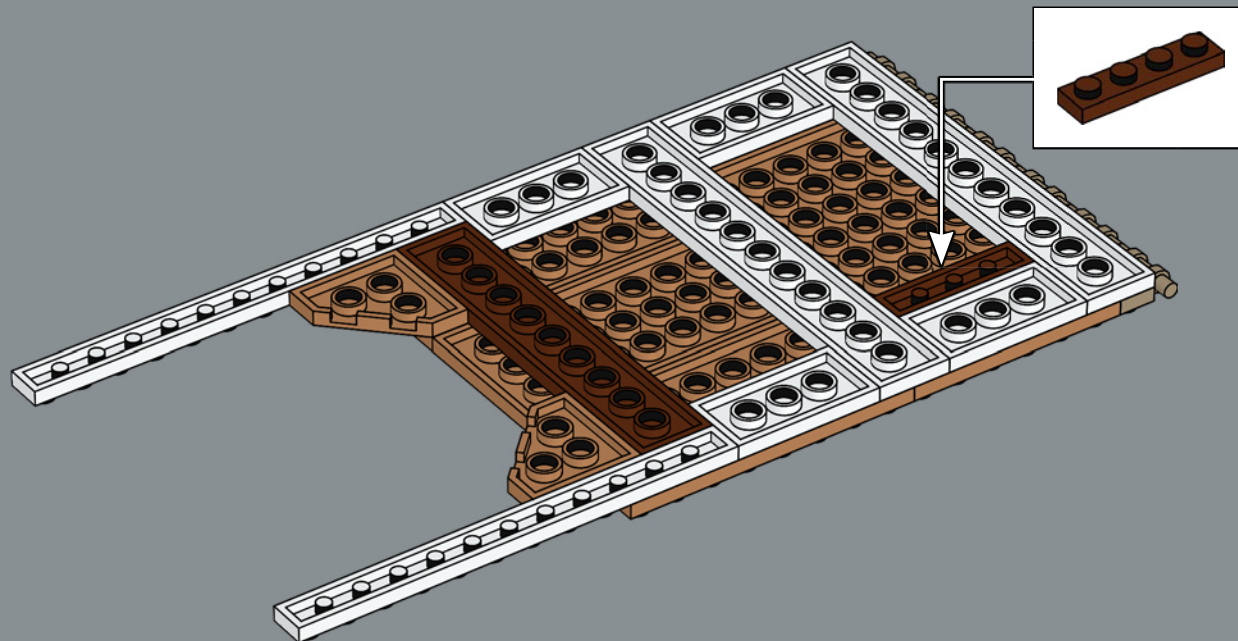

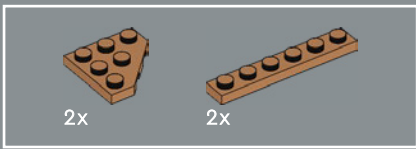

171

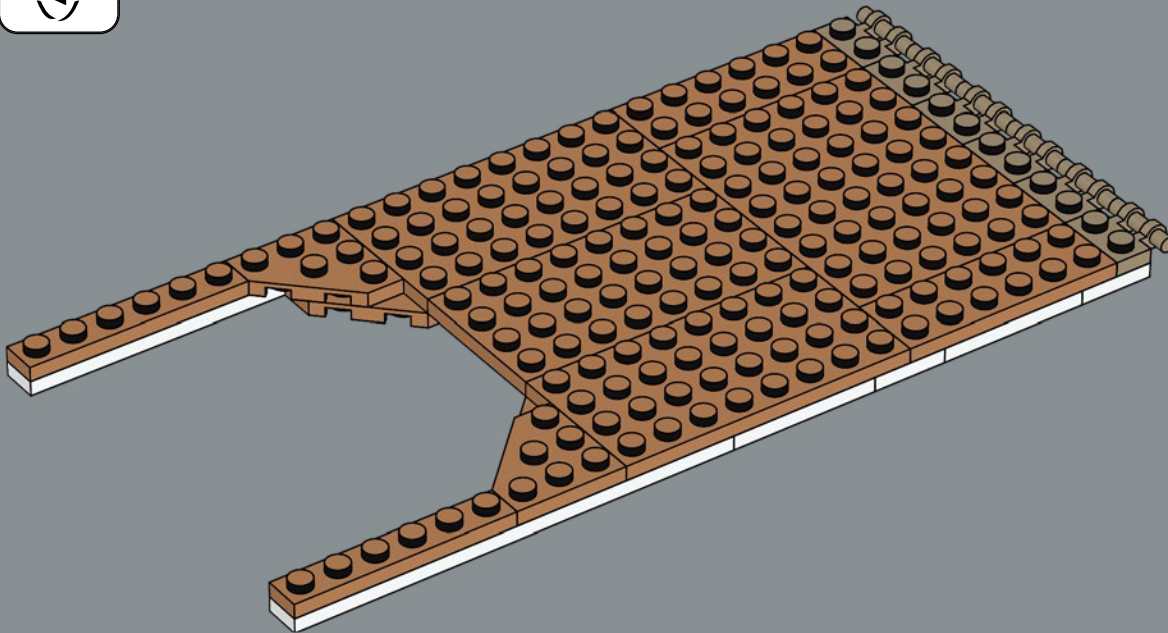



18x



172

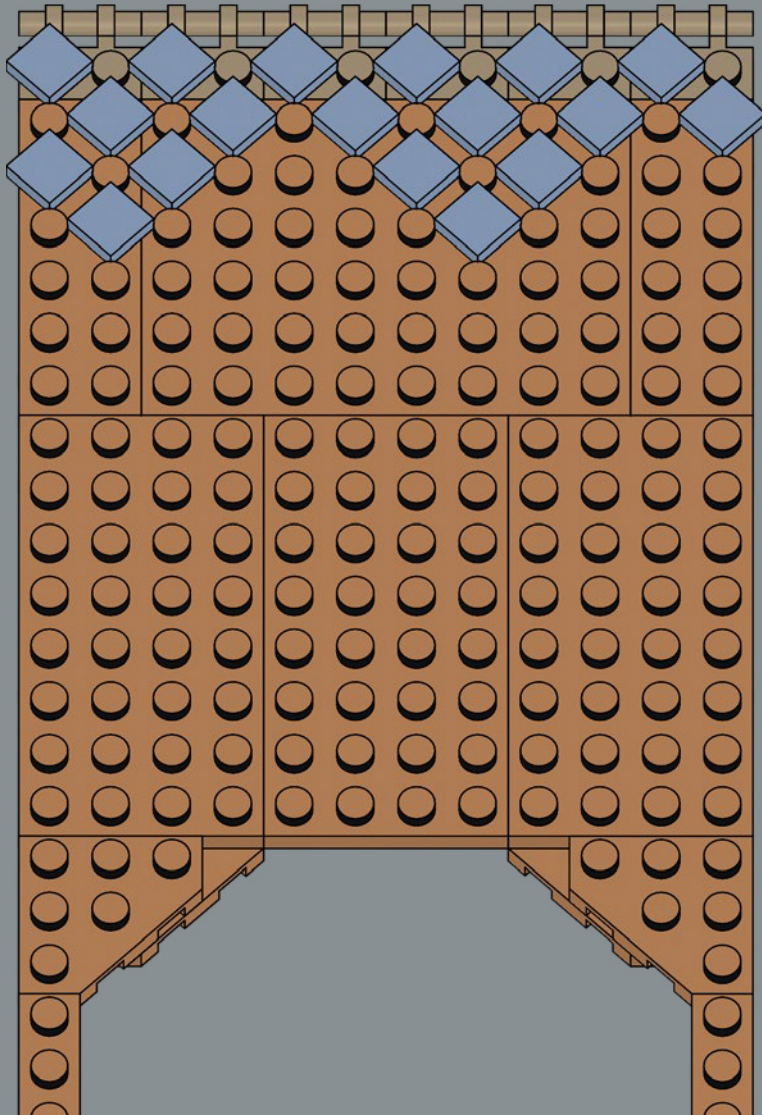

12x



8x

173

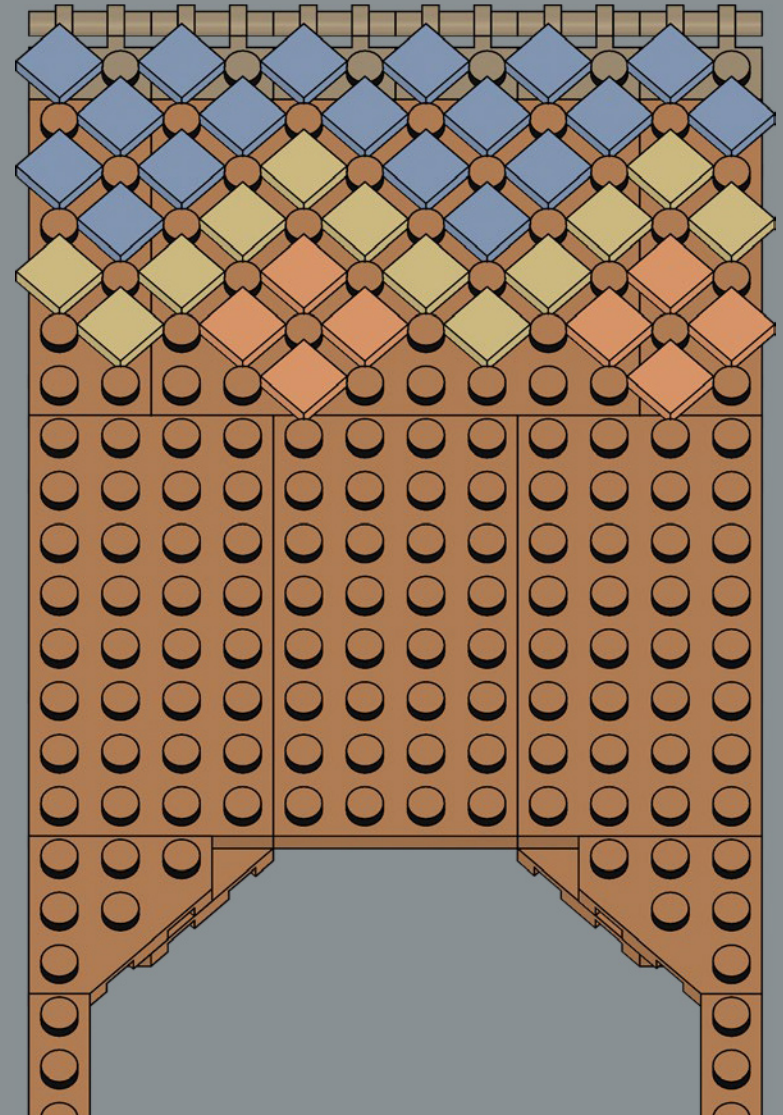

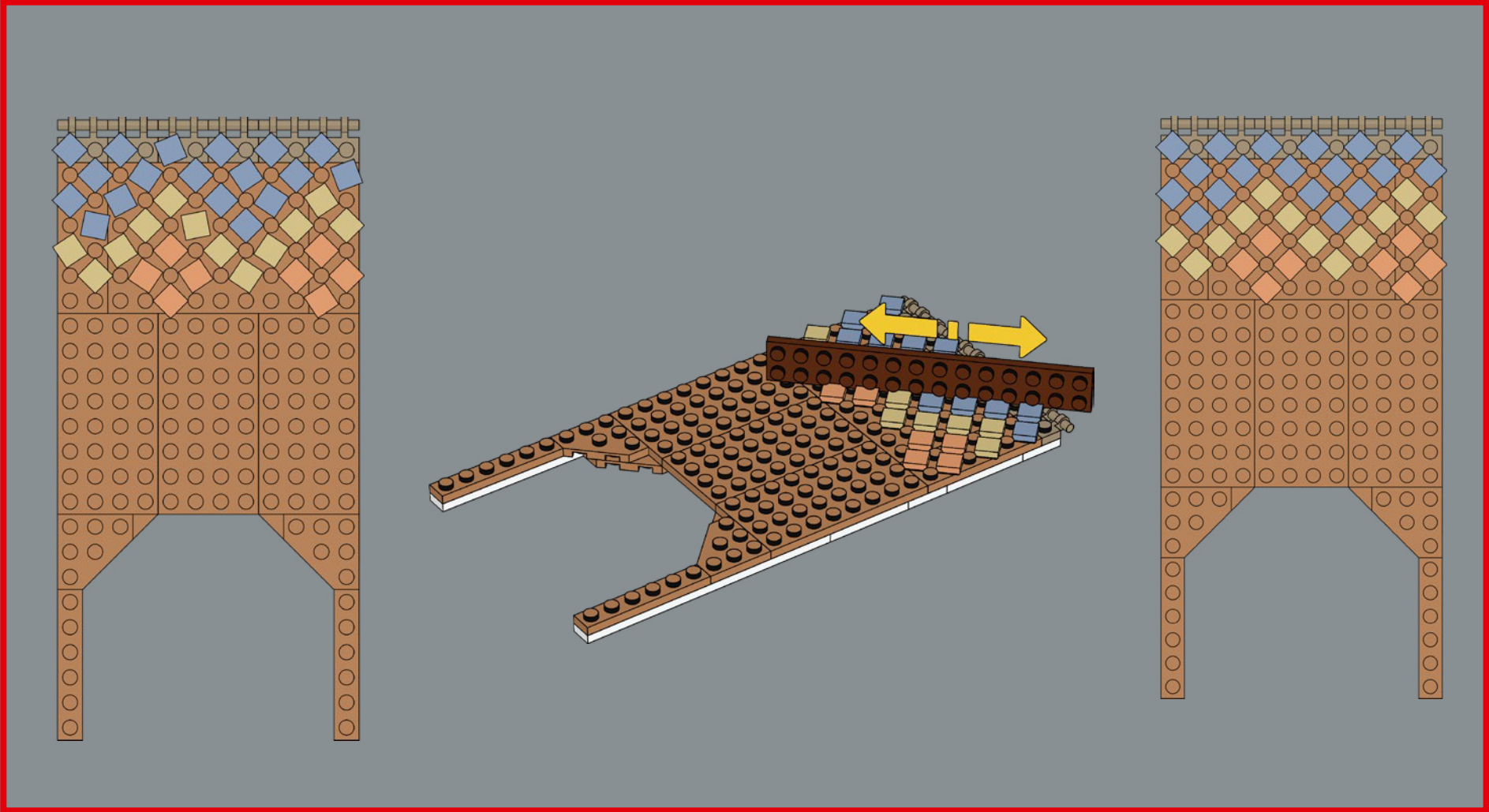



174

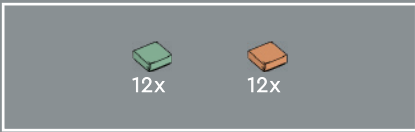
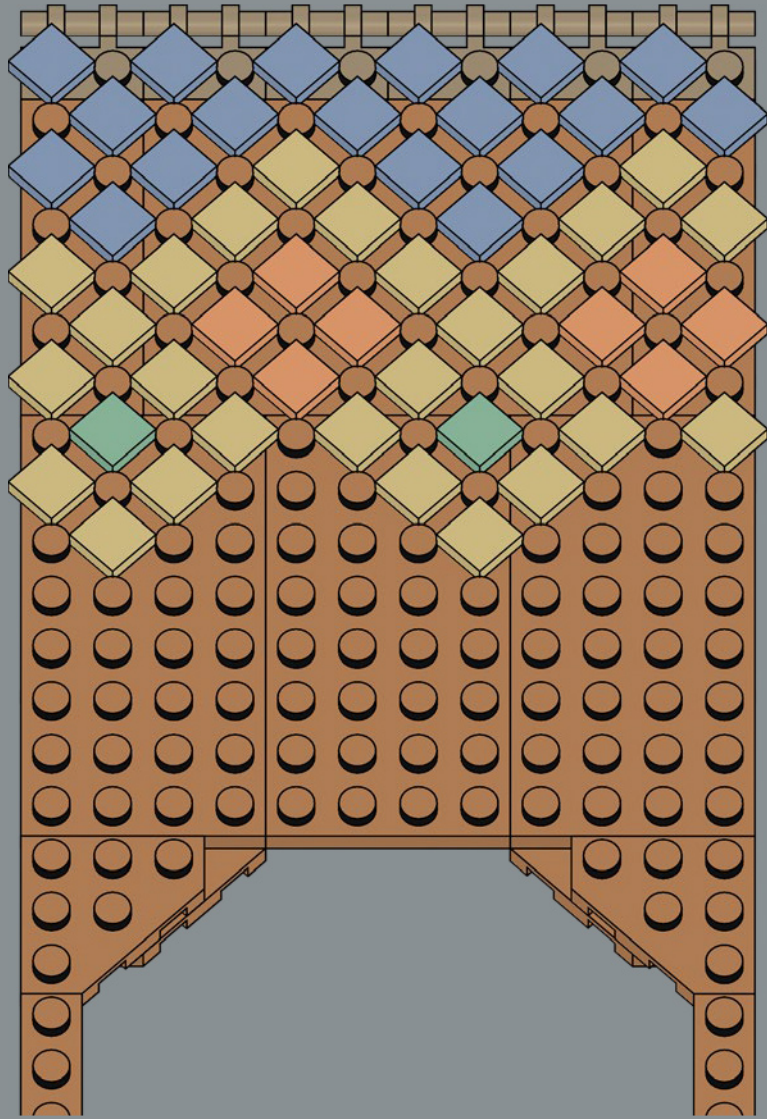

175

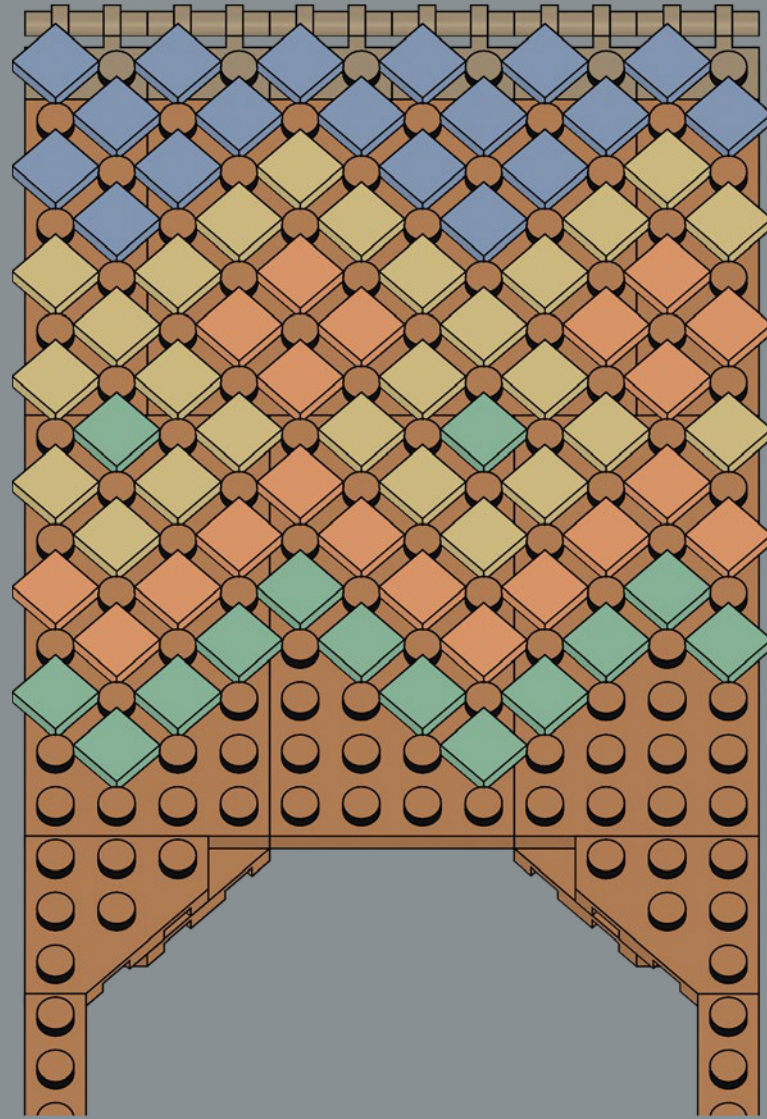



 5x	 6x	 11x
--	--	---

176

Each of the 94 1x1 tiles of the roof should be mounted at a 45-degree angle. Running a long plate or tile through the grooves once the parts are in place is a great way to align them all.

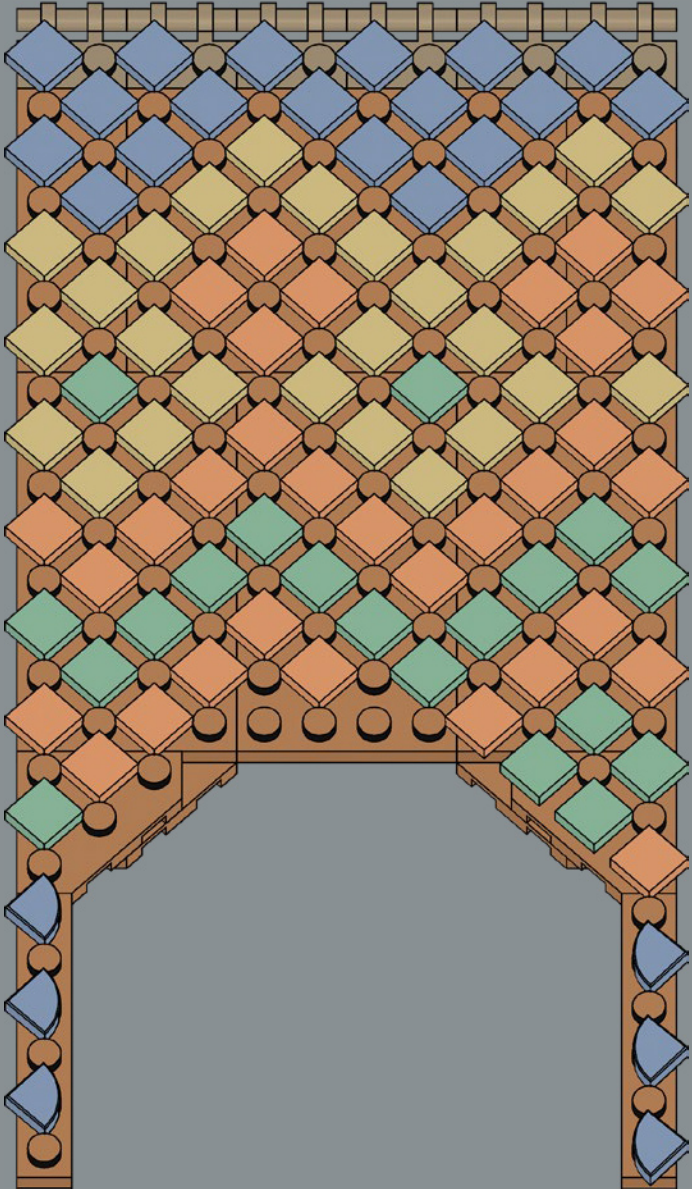



6x

177

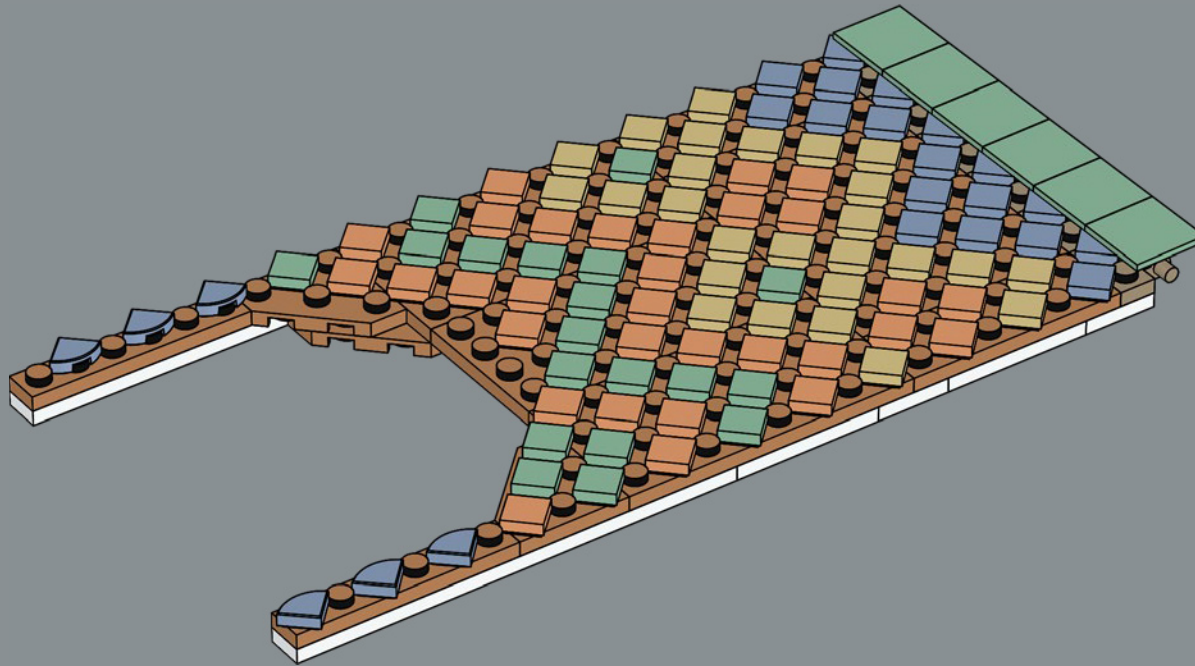



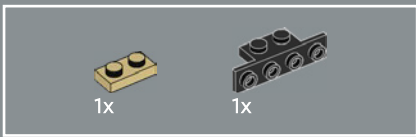

178

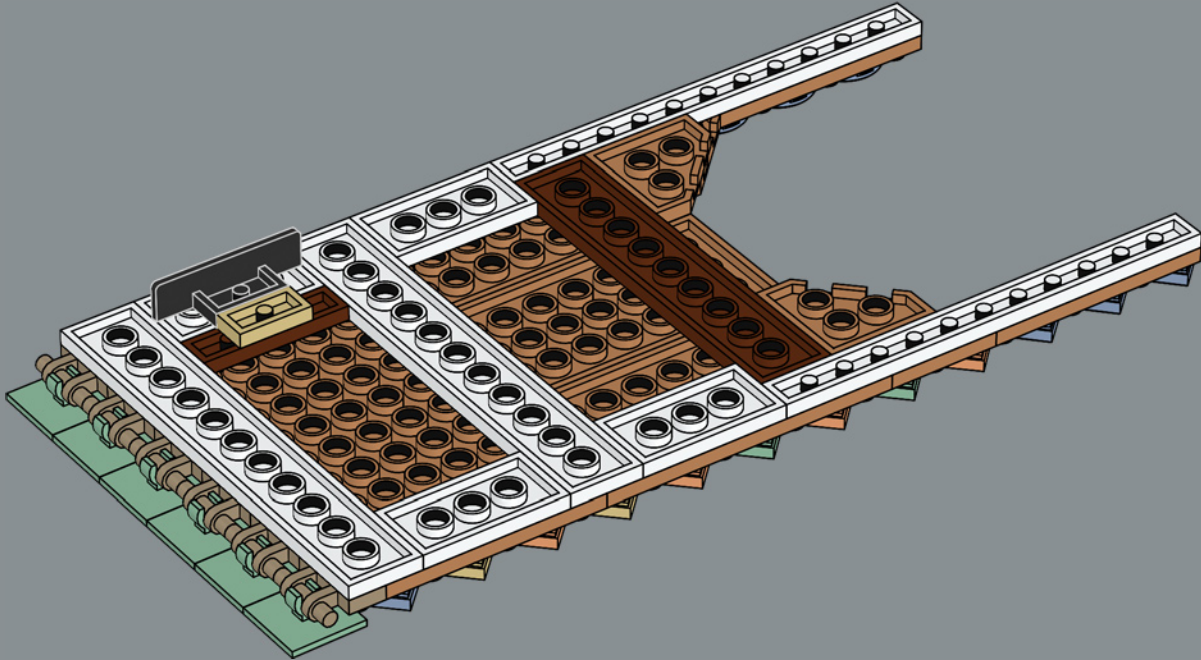



179

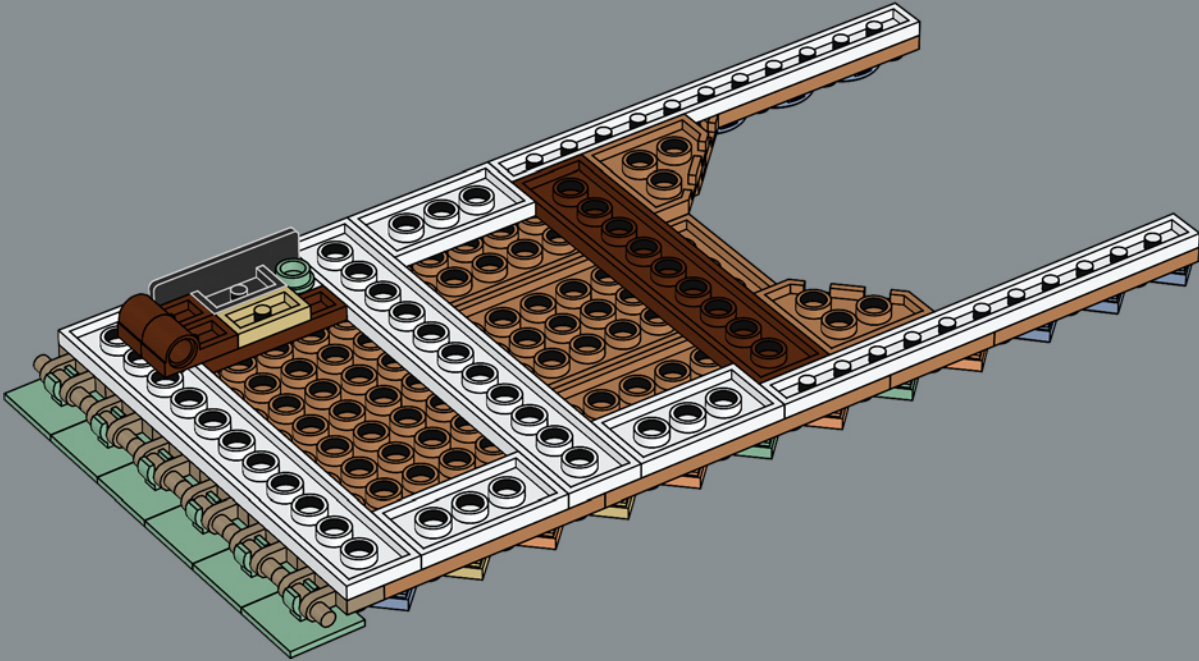

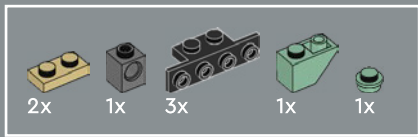

180

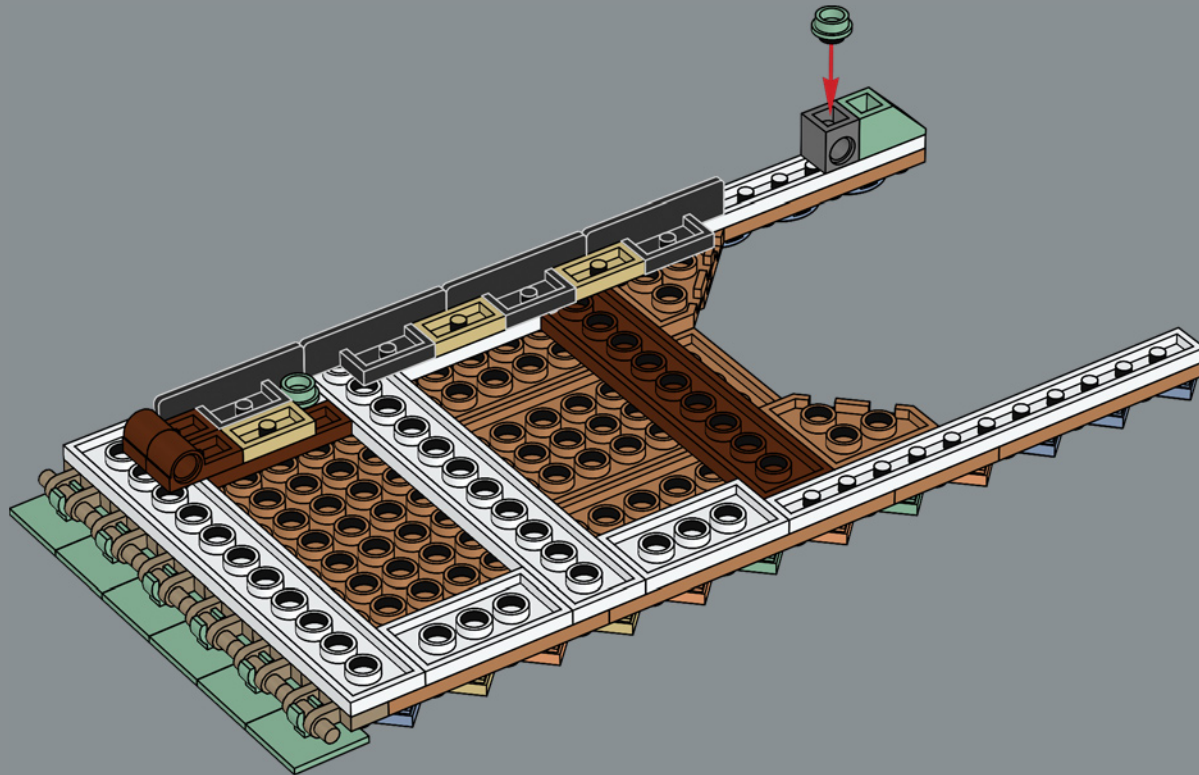

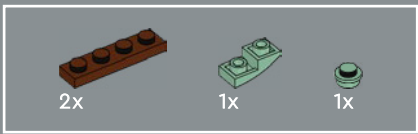

181

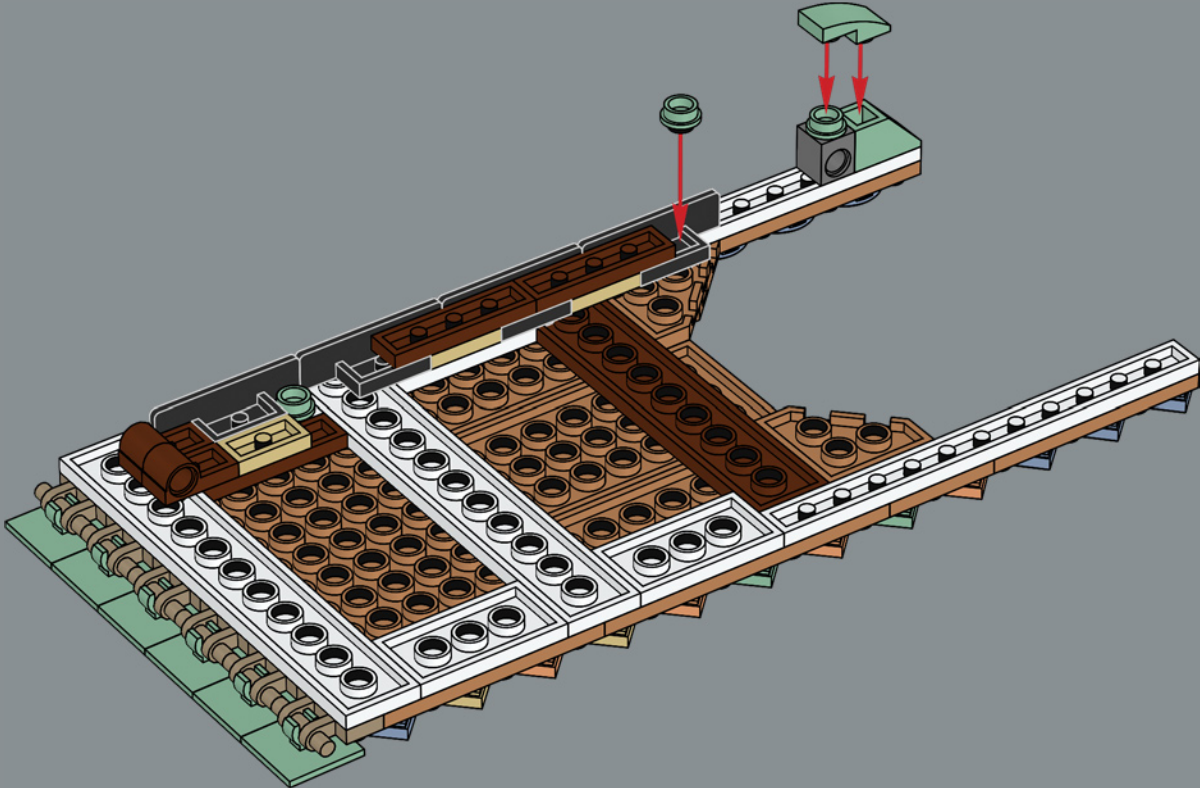

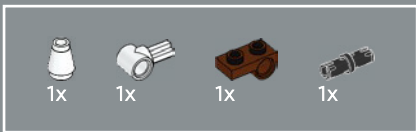

182

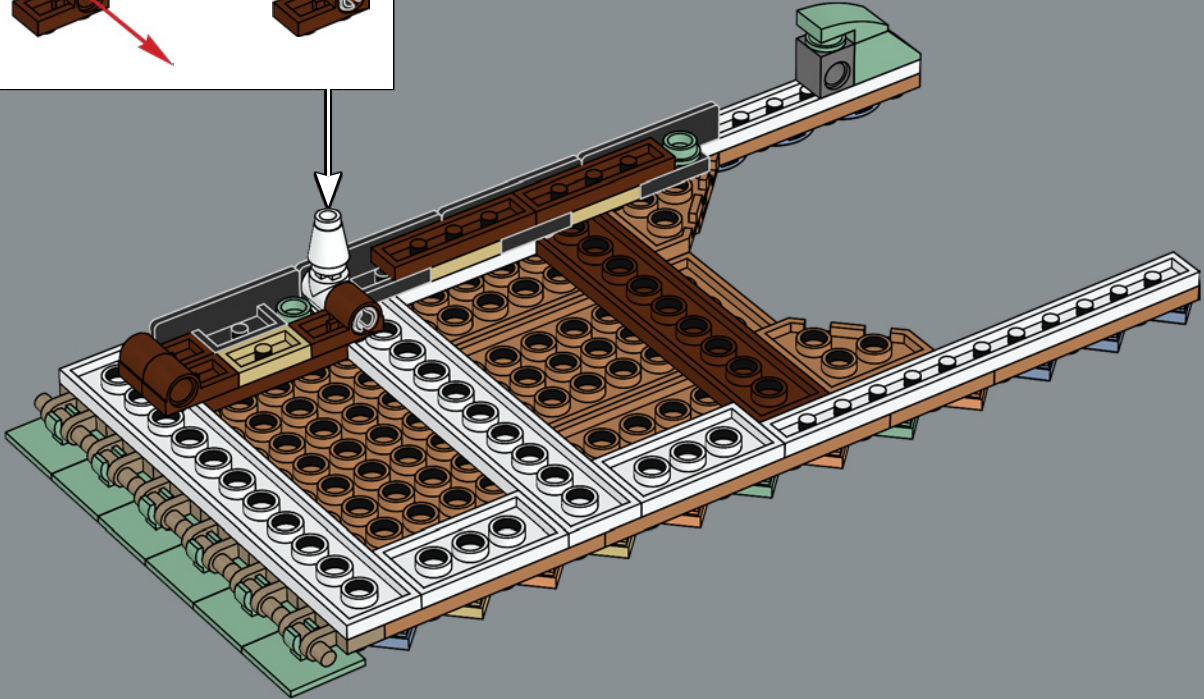
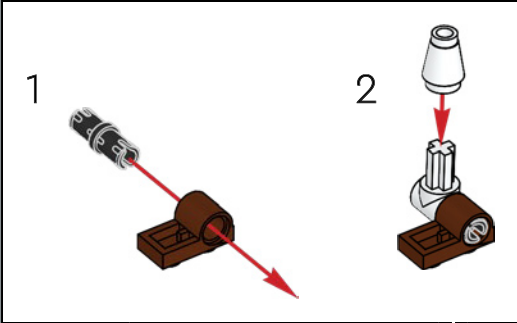

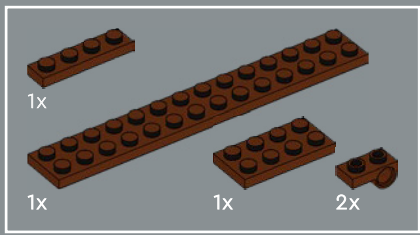

183

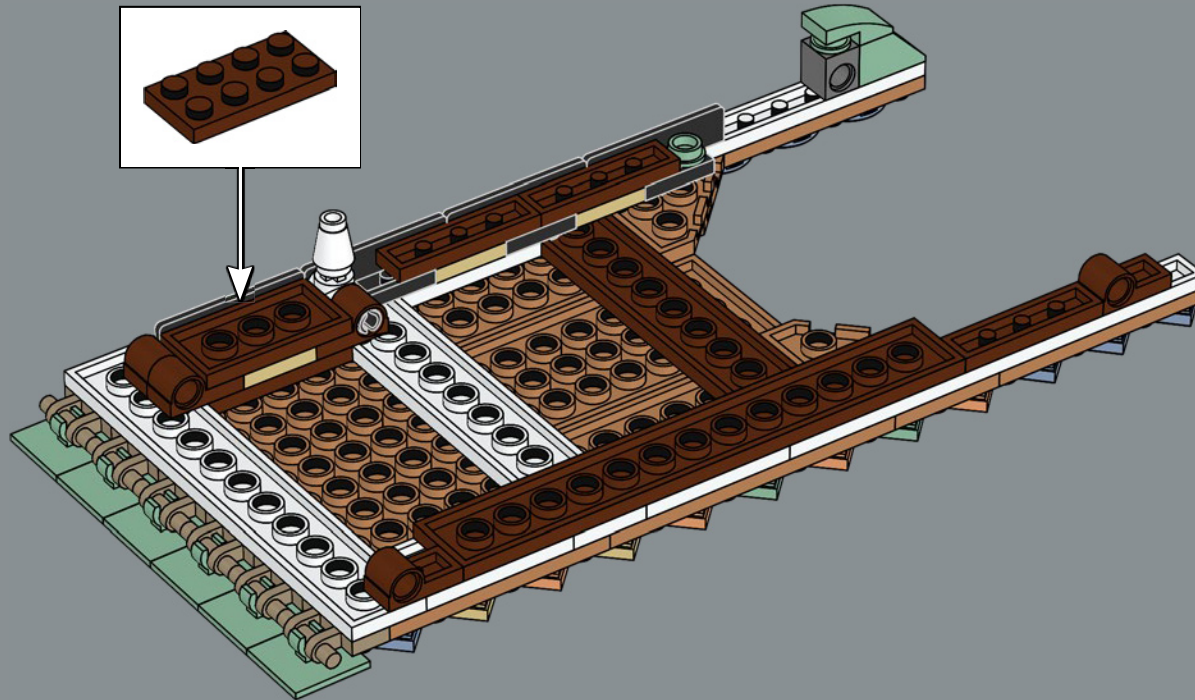

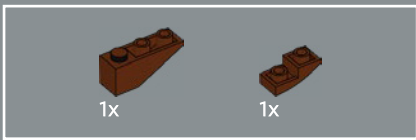

184

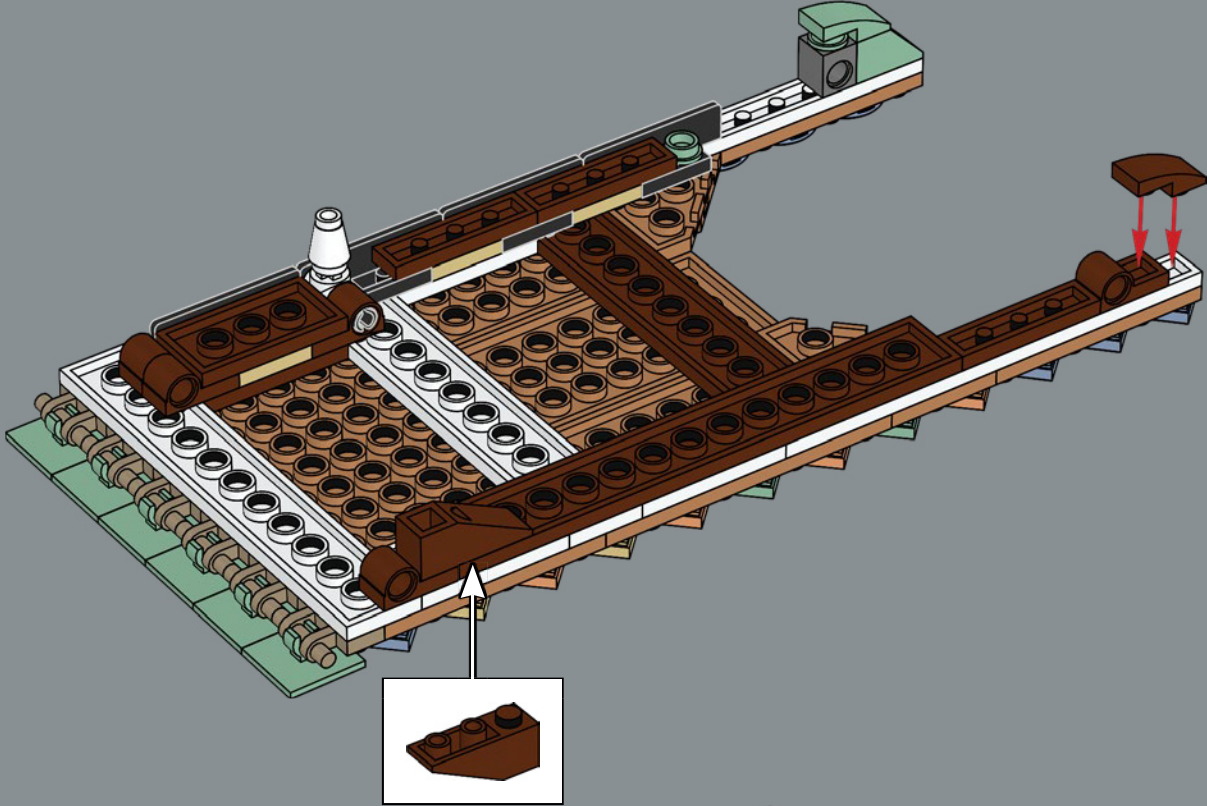

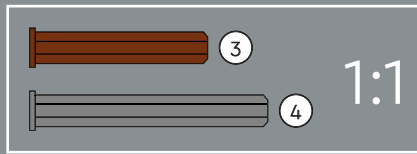
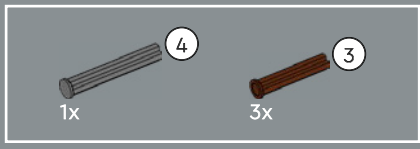

185

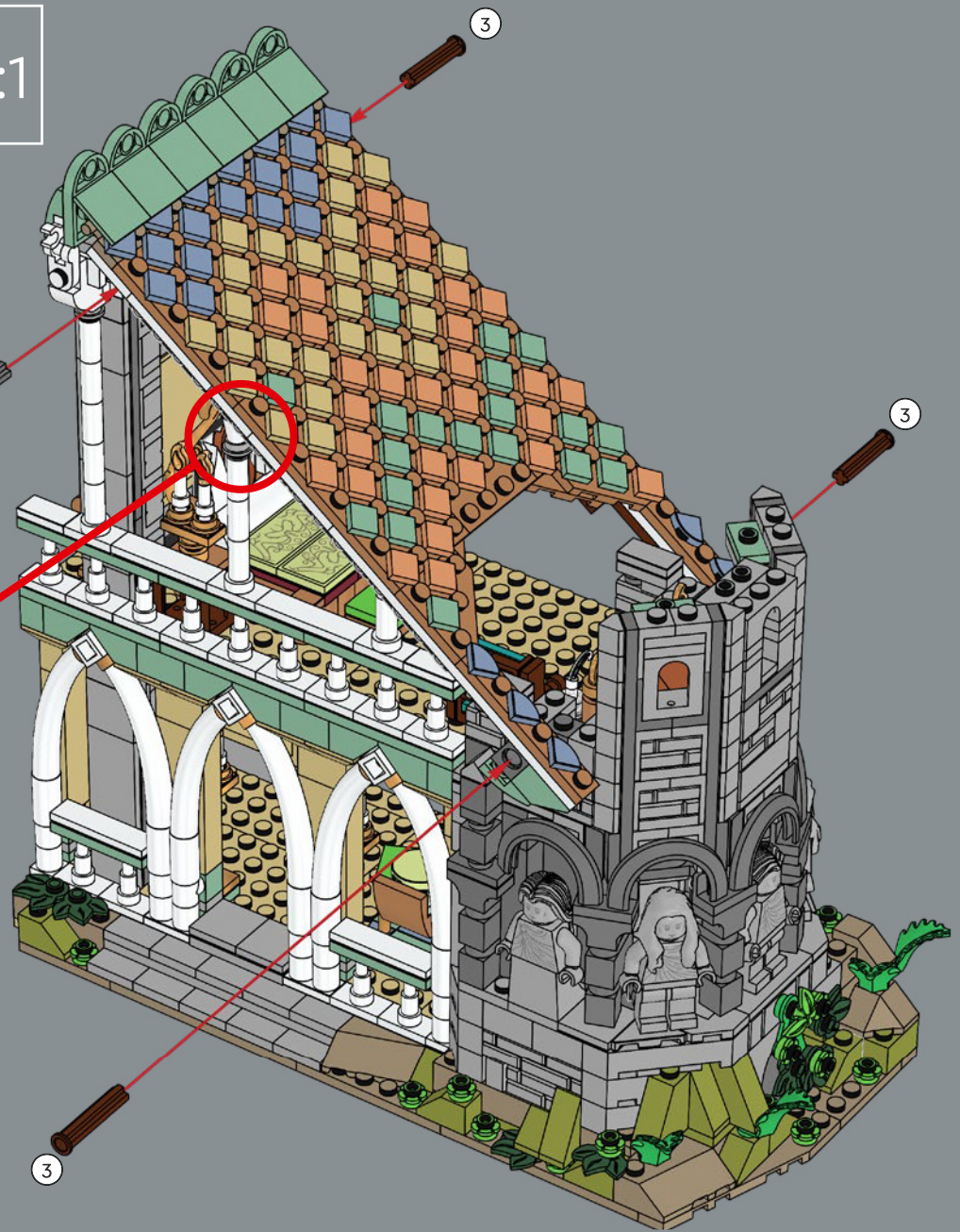
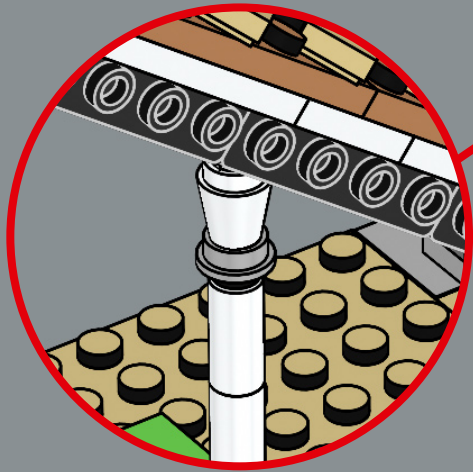
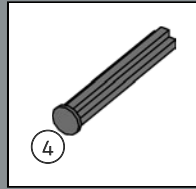



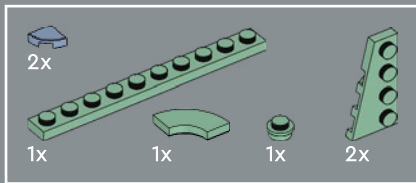

186

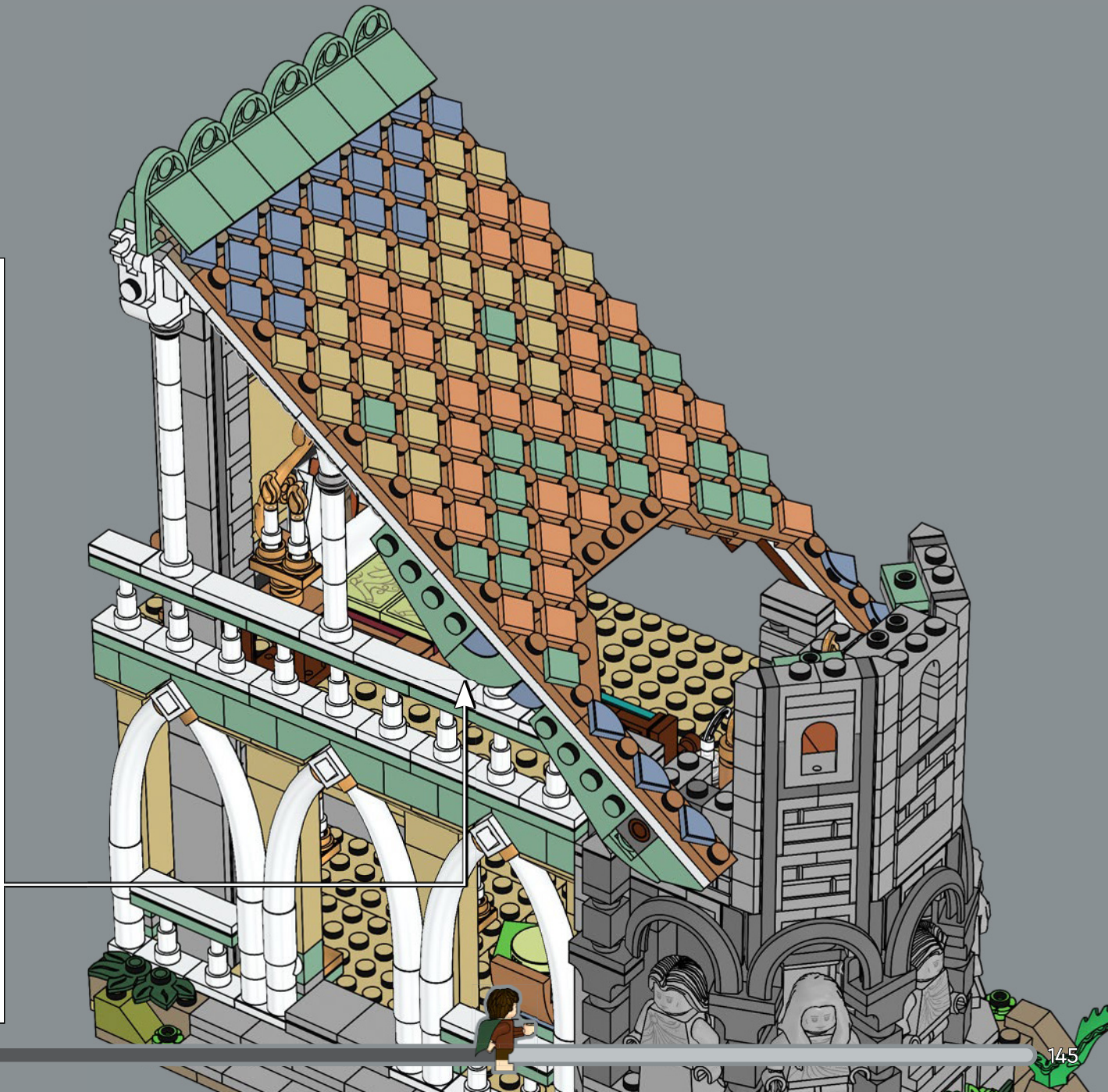
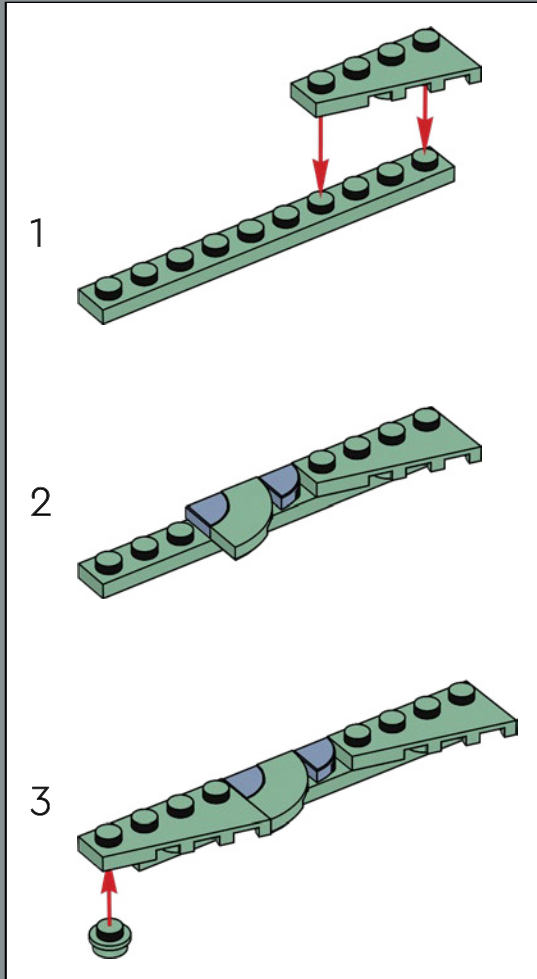

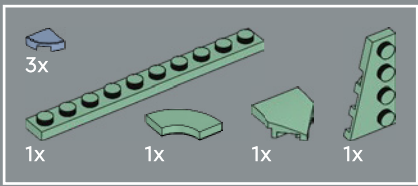

187

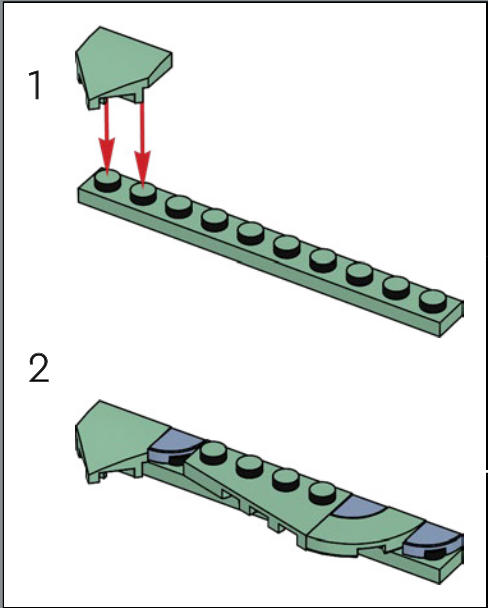

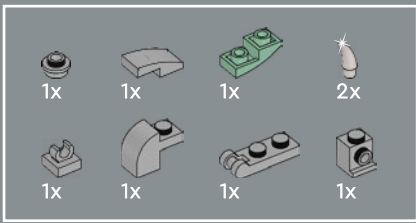

188

1

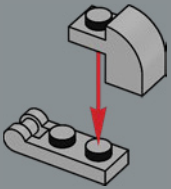

2

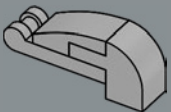

3

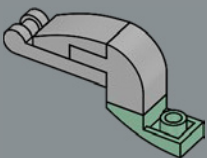

4

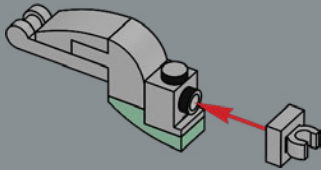

5

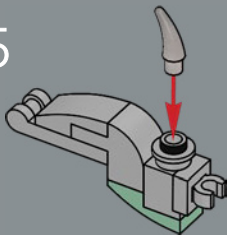

6

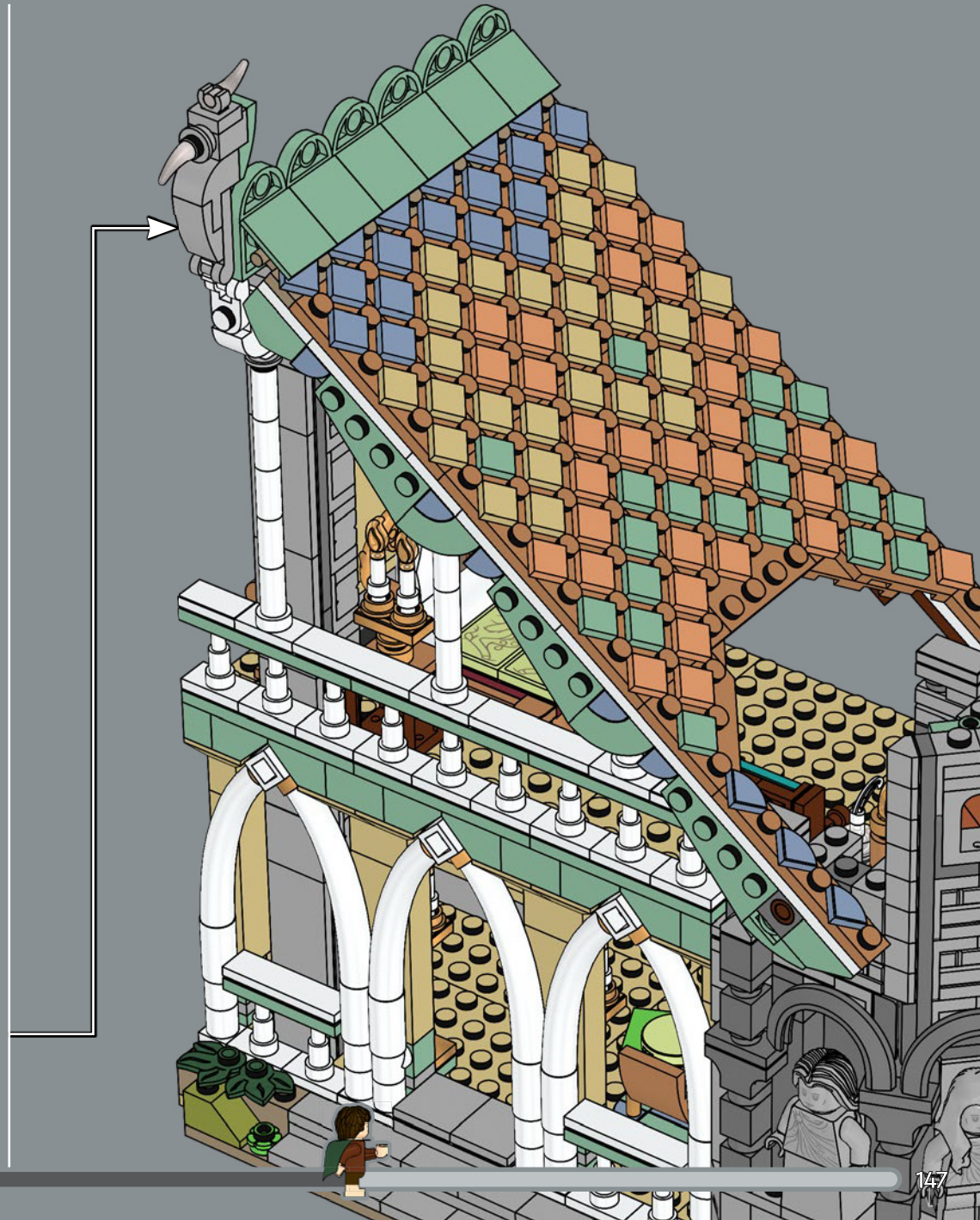
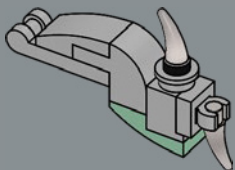

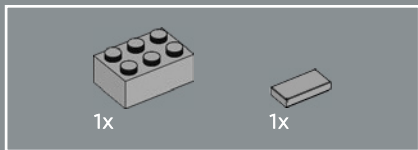

189

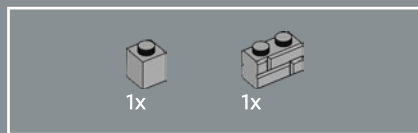
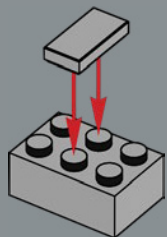

190

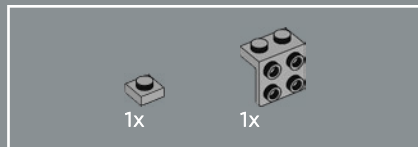
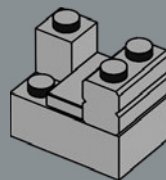

191

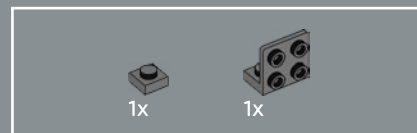
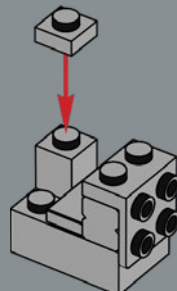

192

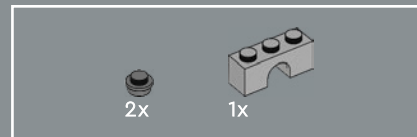
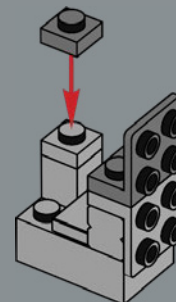

193

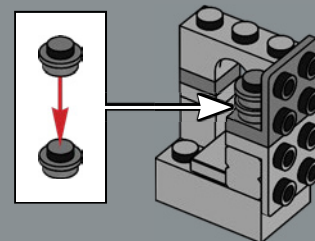

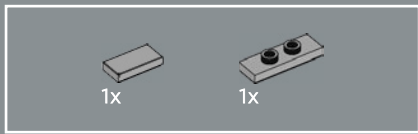

194

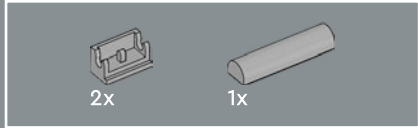
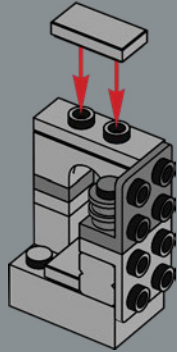

195

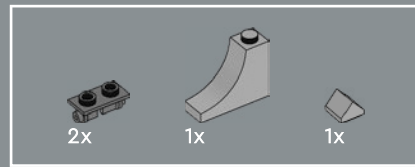
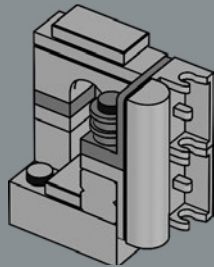

196

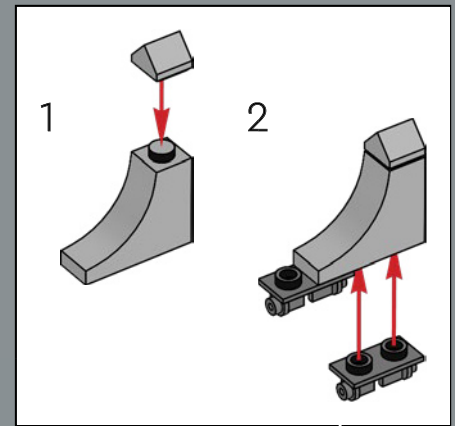
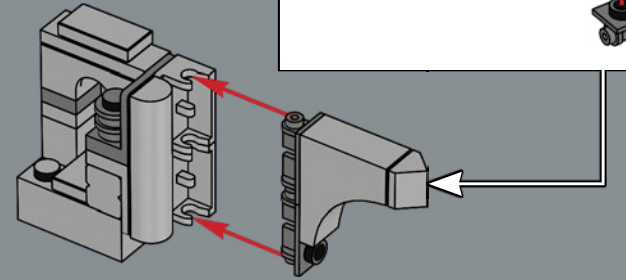

197

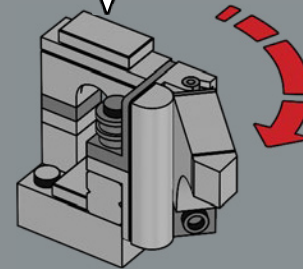

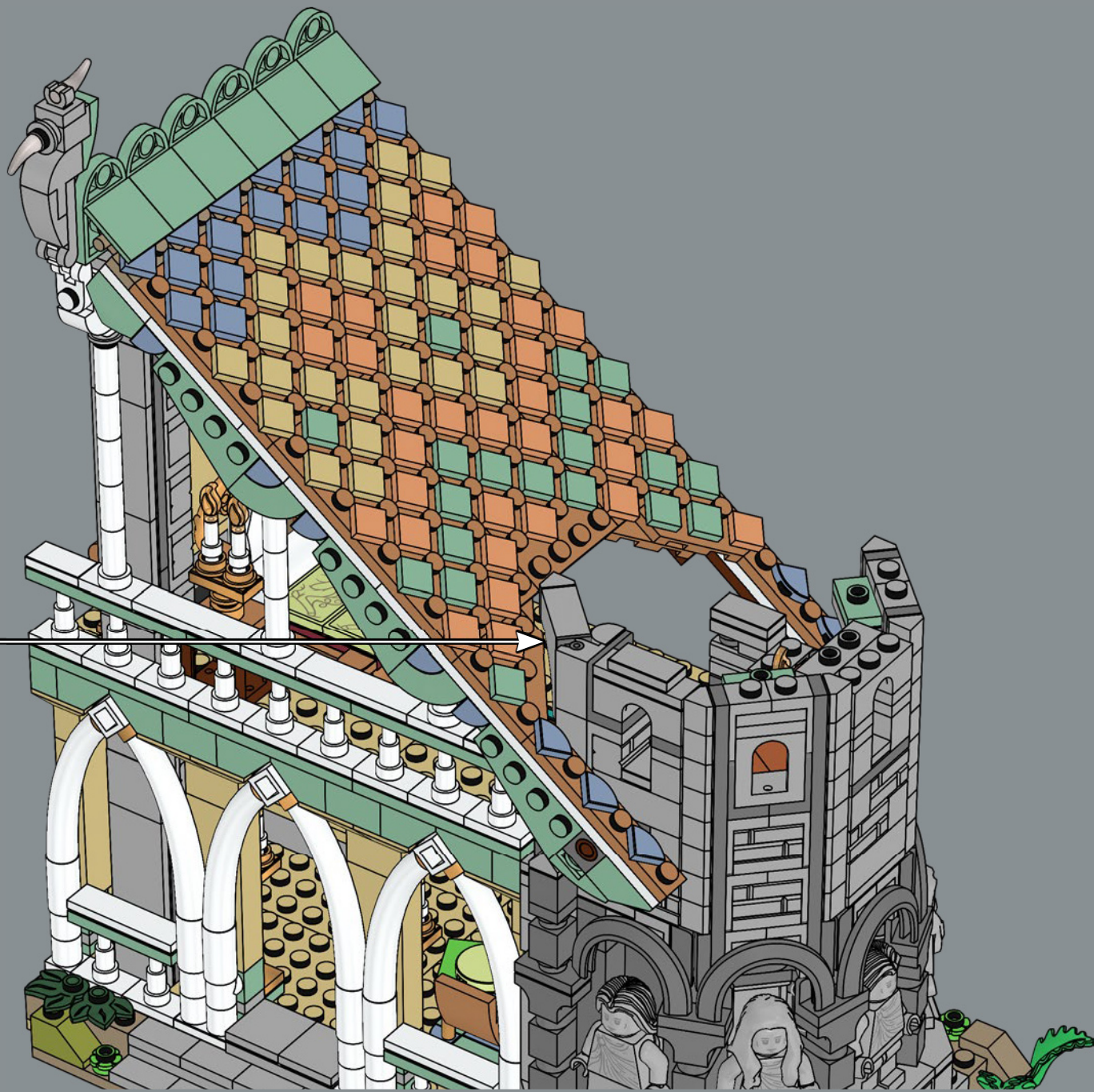

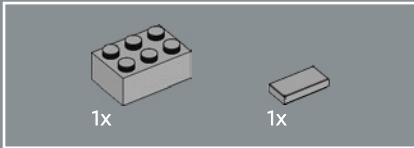
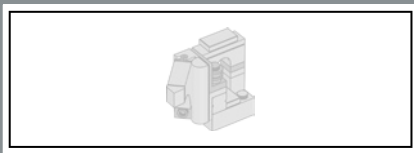

199

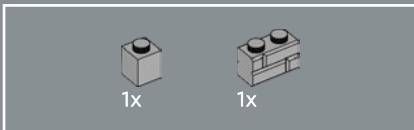
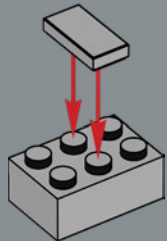

200

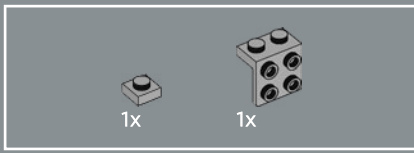
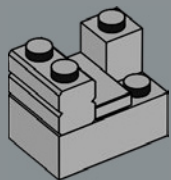

201

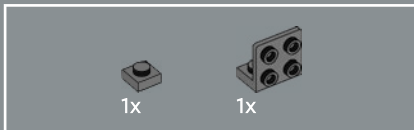
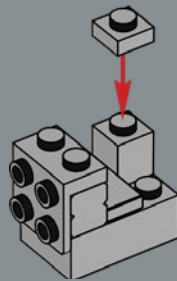

202

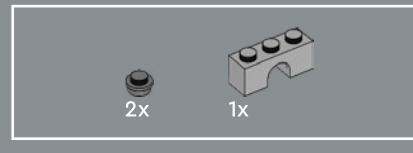
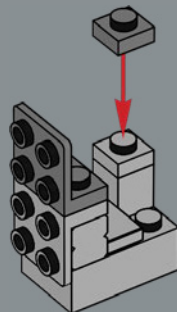

203

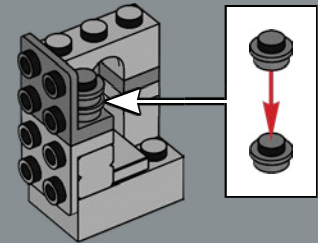

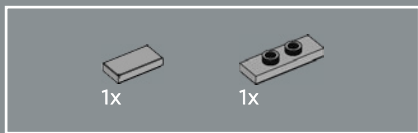

204

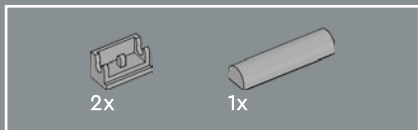
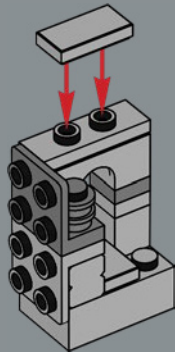

205

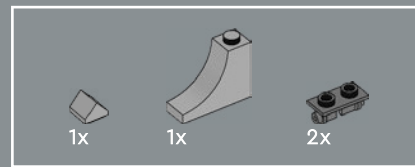
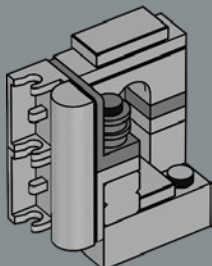

206

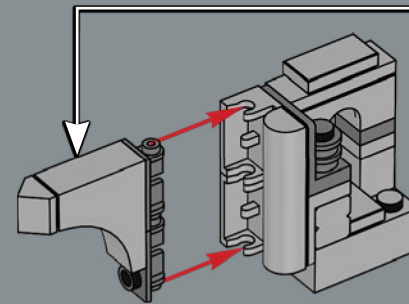
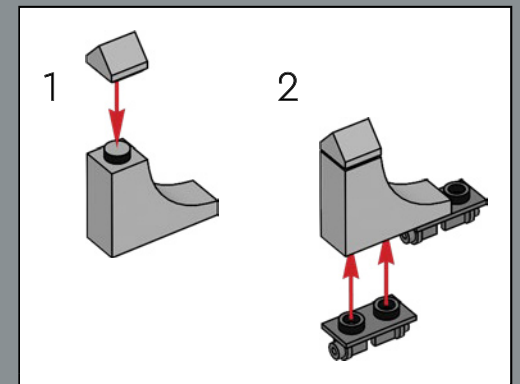

207

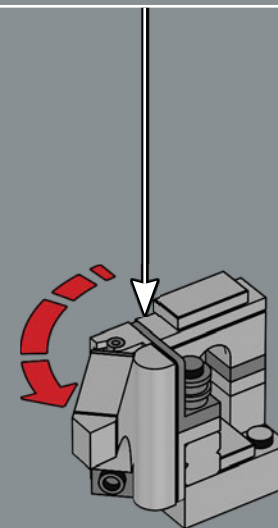



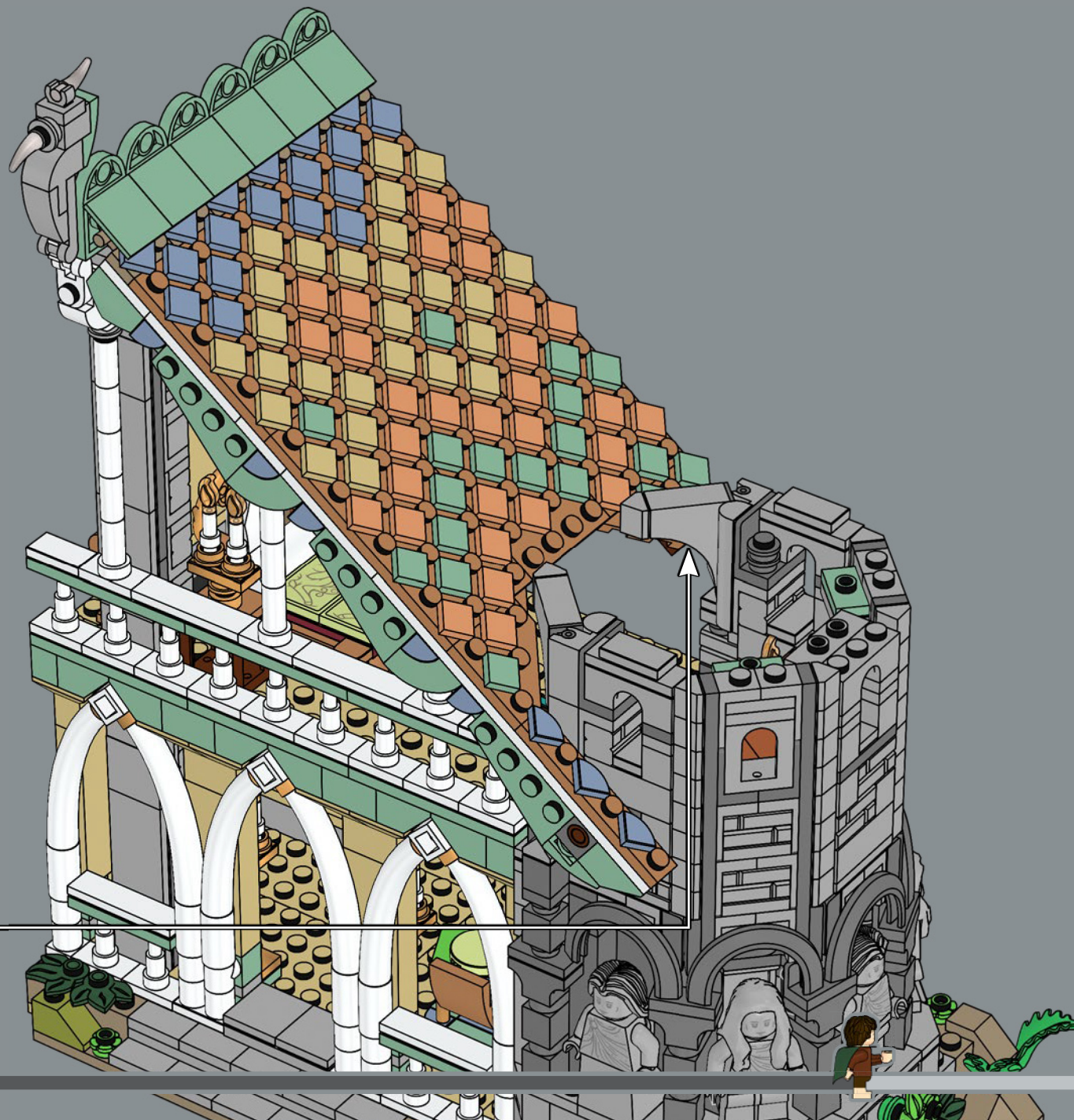

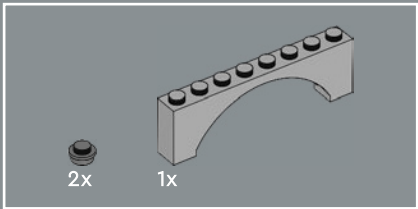

209

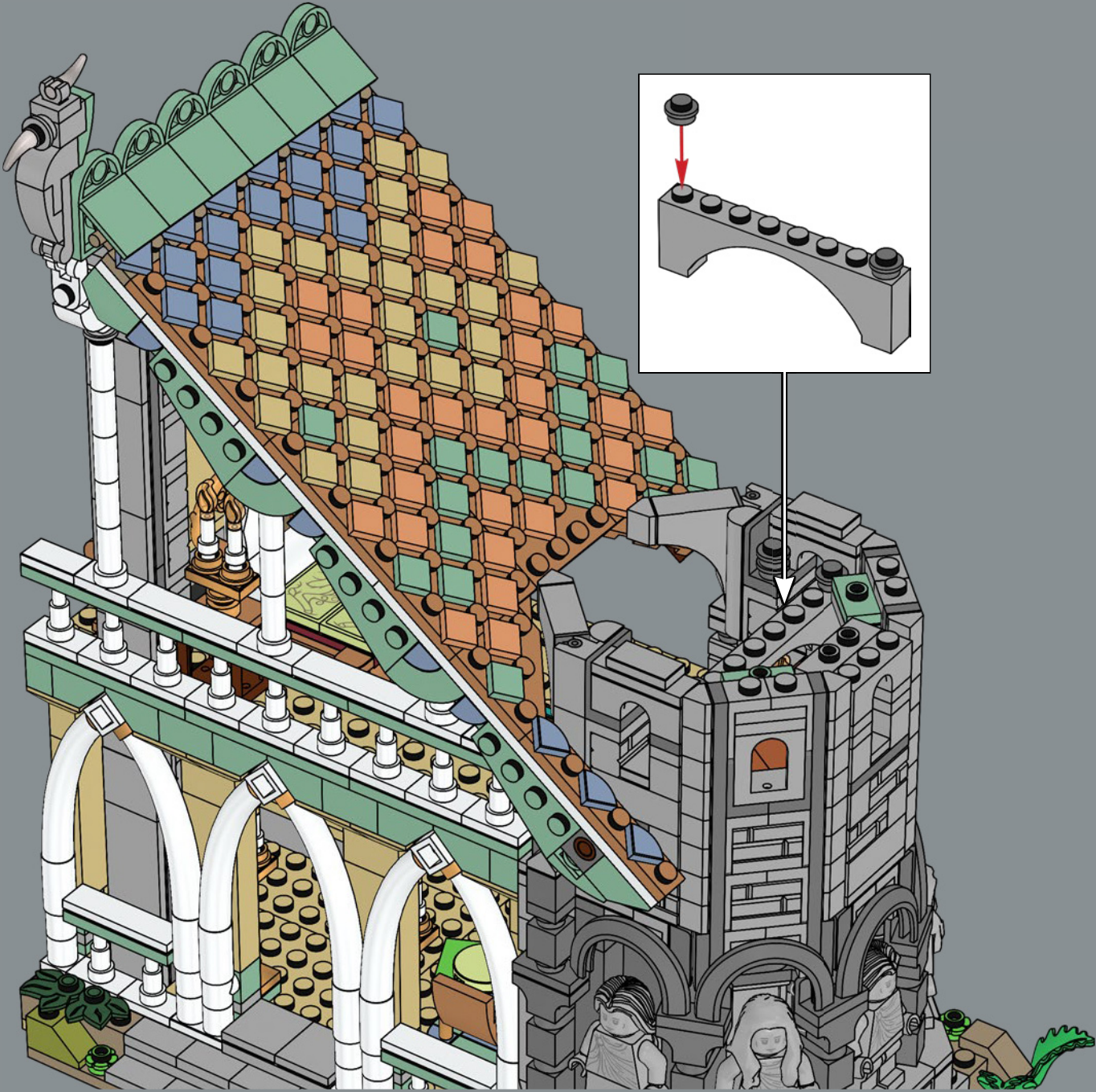

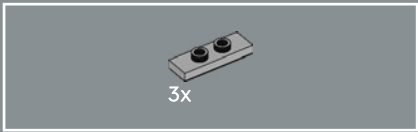

210

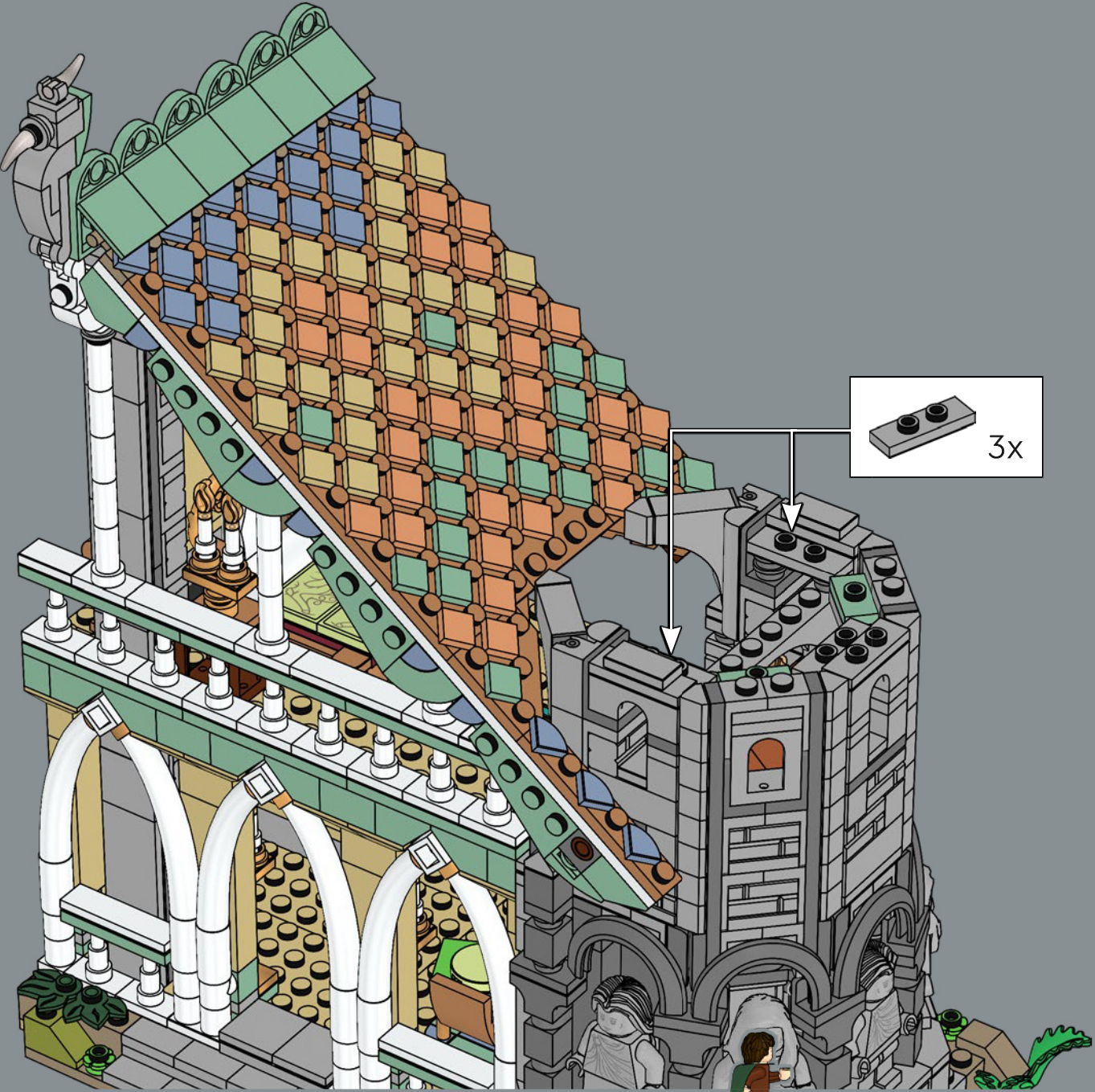



211

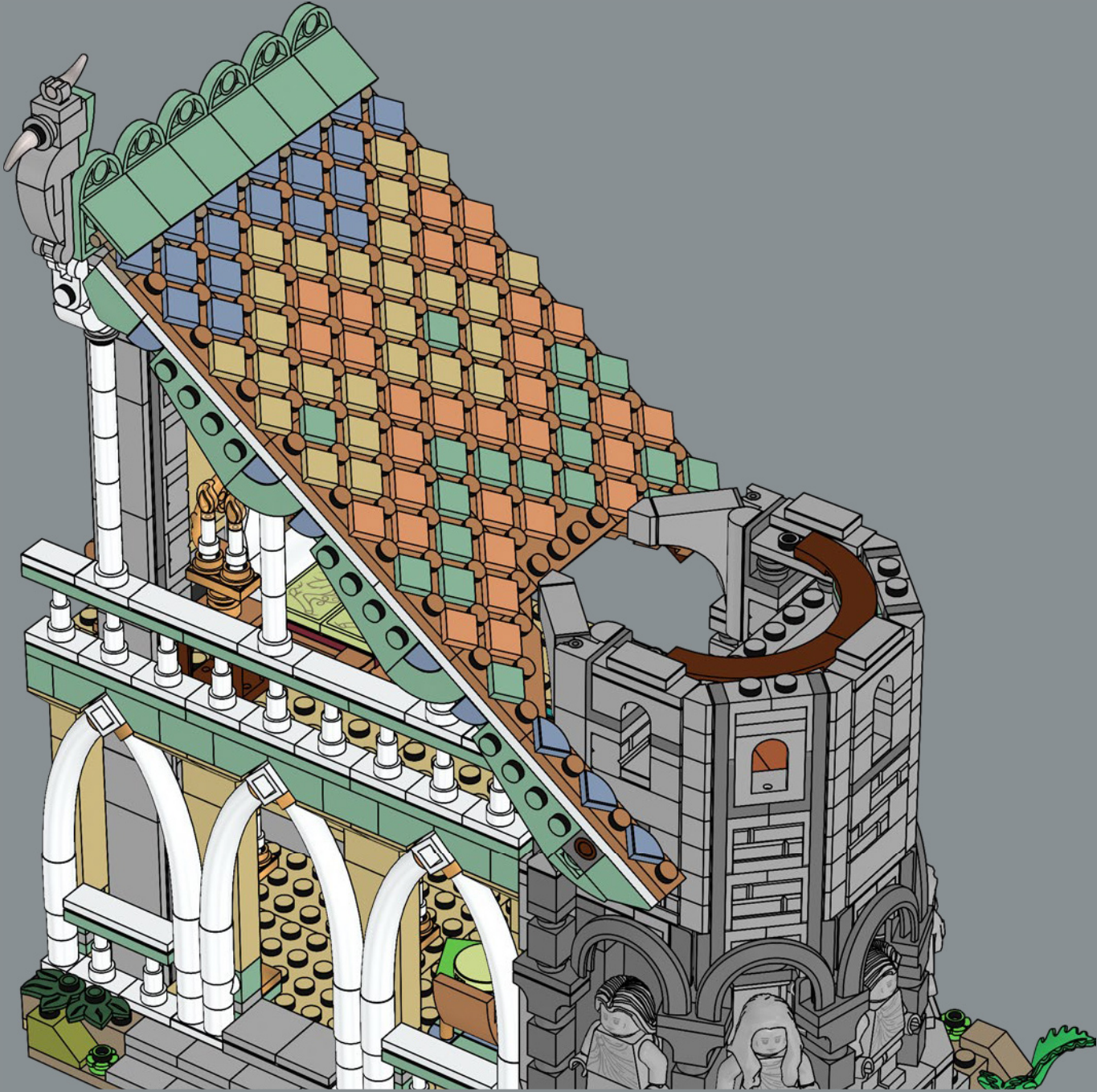

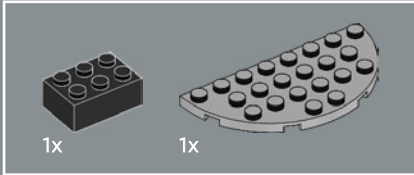
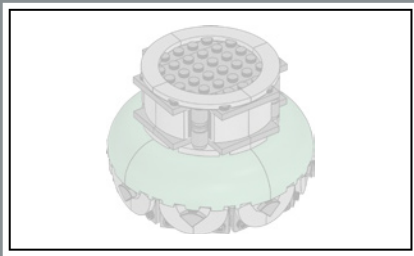

212

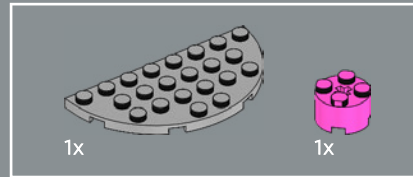
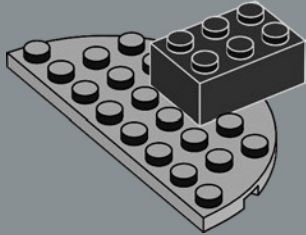

213

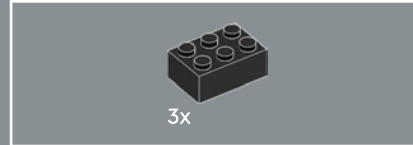
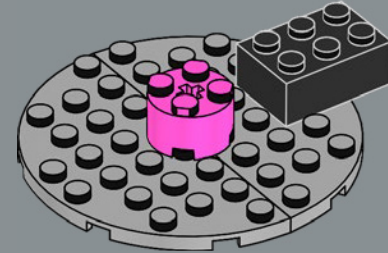

214

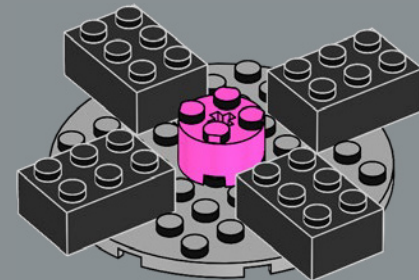

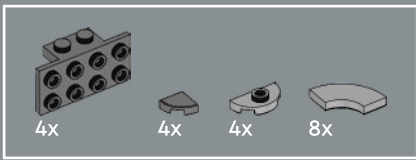

215

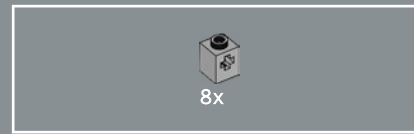
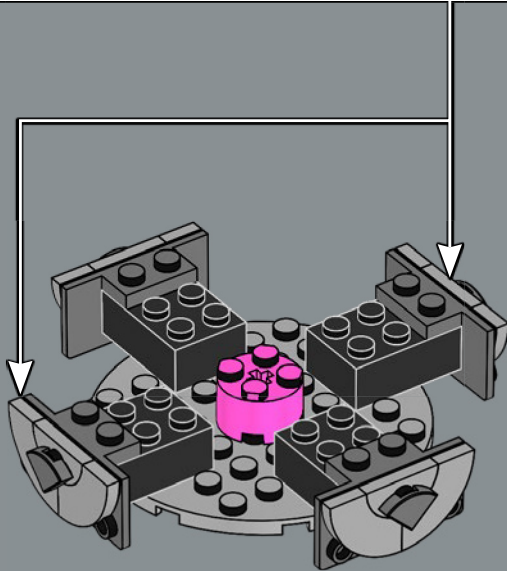
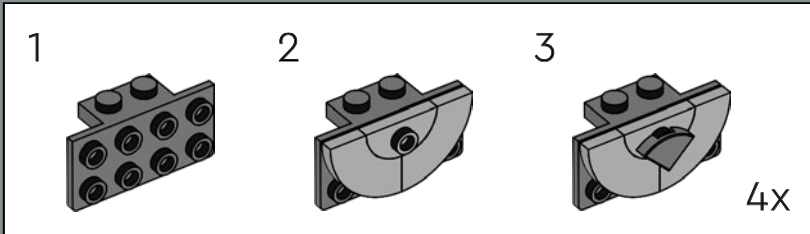

216

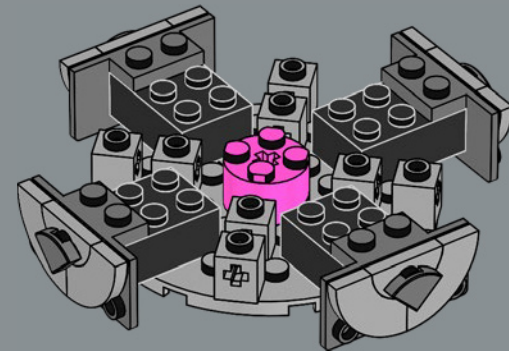

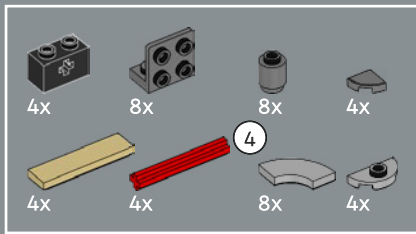

217

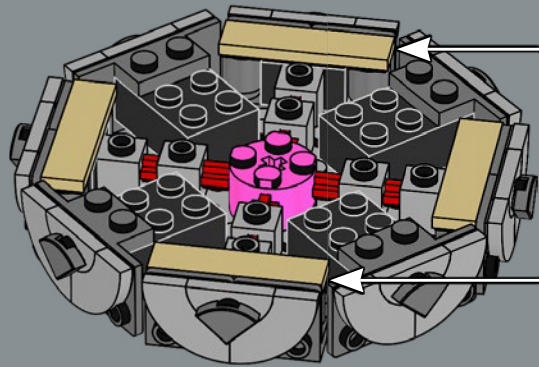
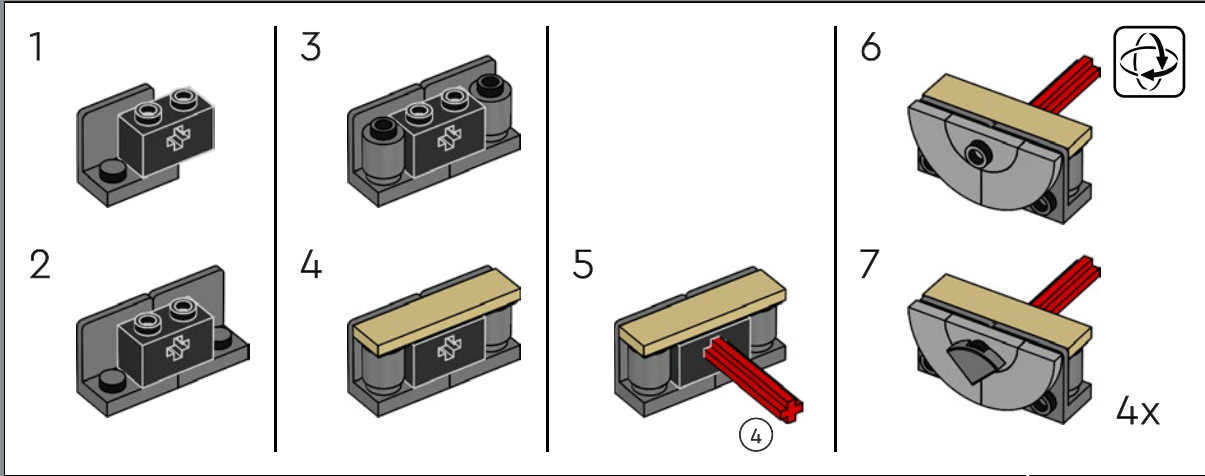

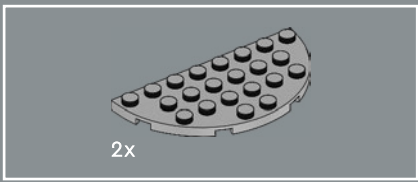

218

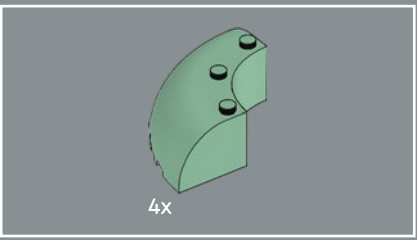
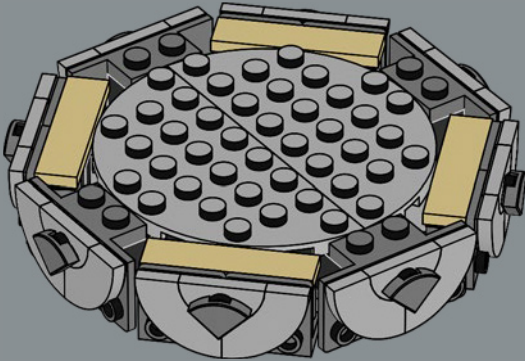

219

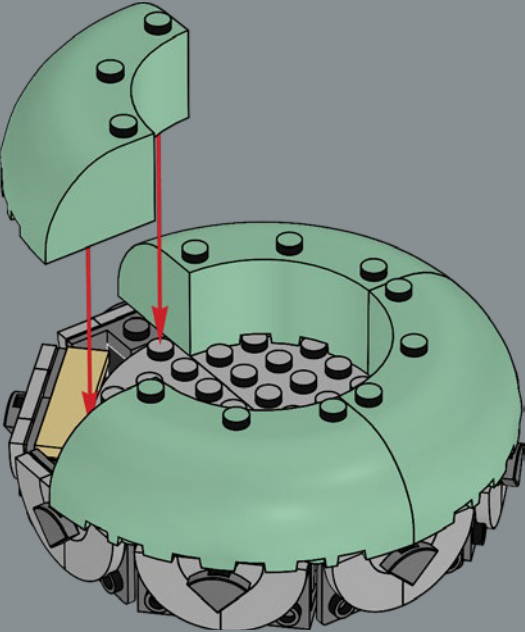



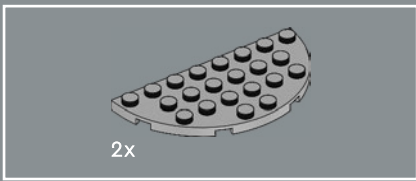

220

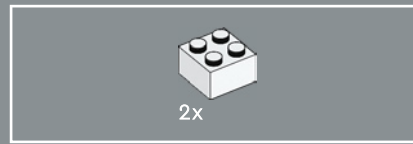
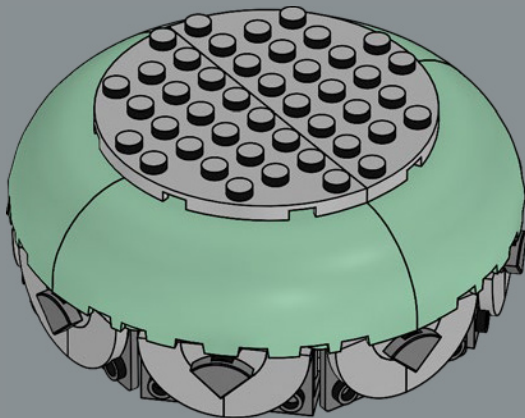

221

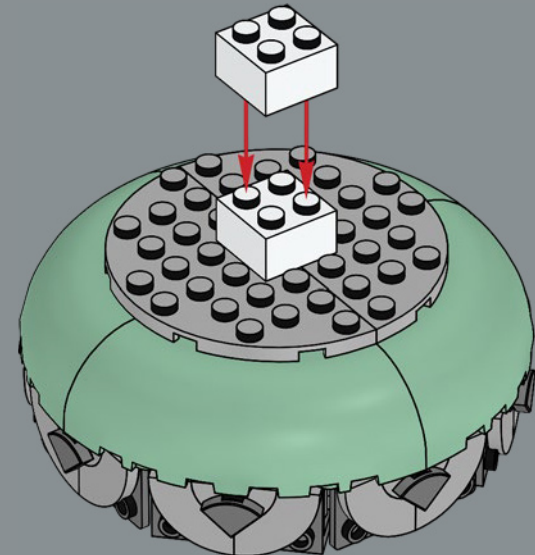

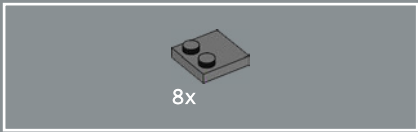

222

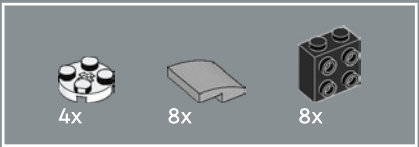
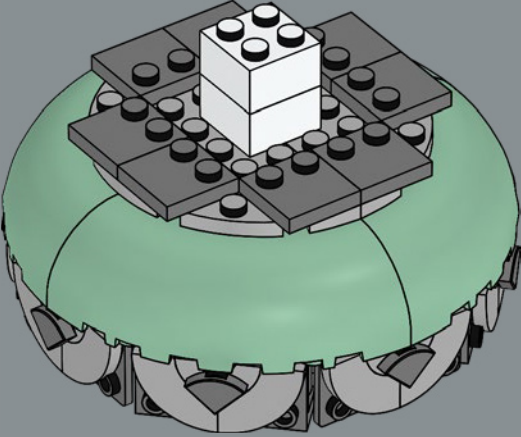

223

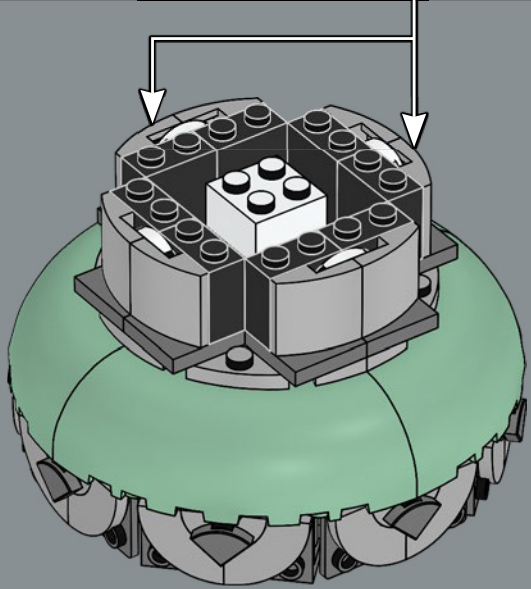
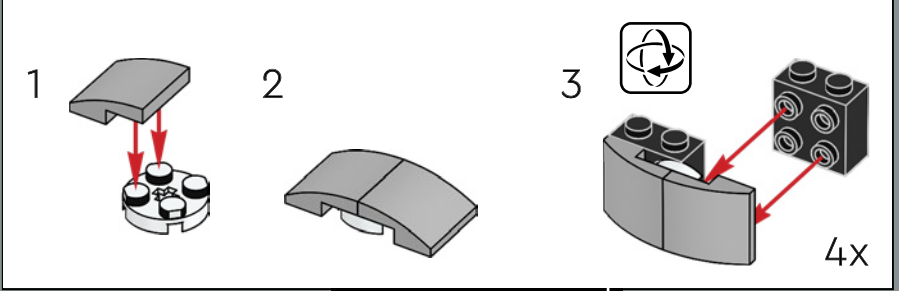

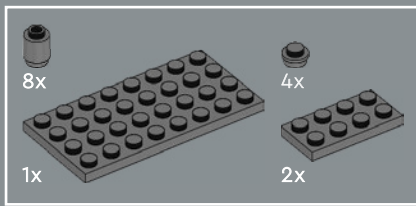

224

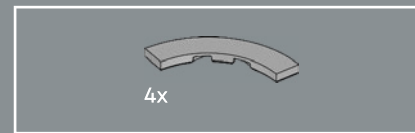
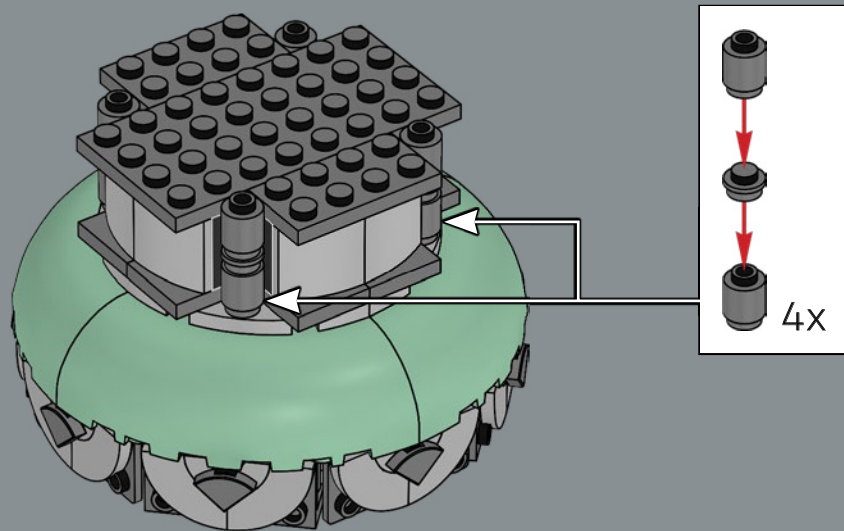

225

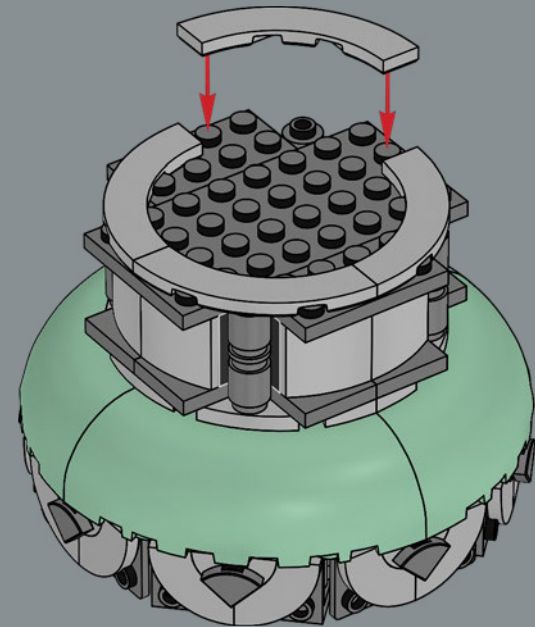



The tower roof is designed to be removable so you can peek in on Bilbo's writing progress.

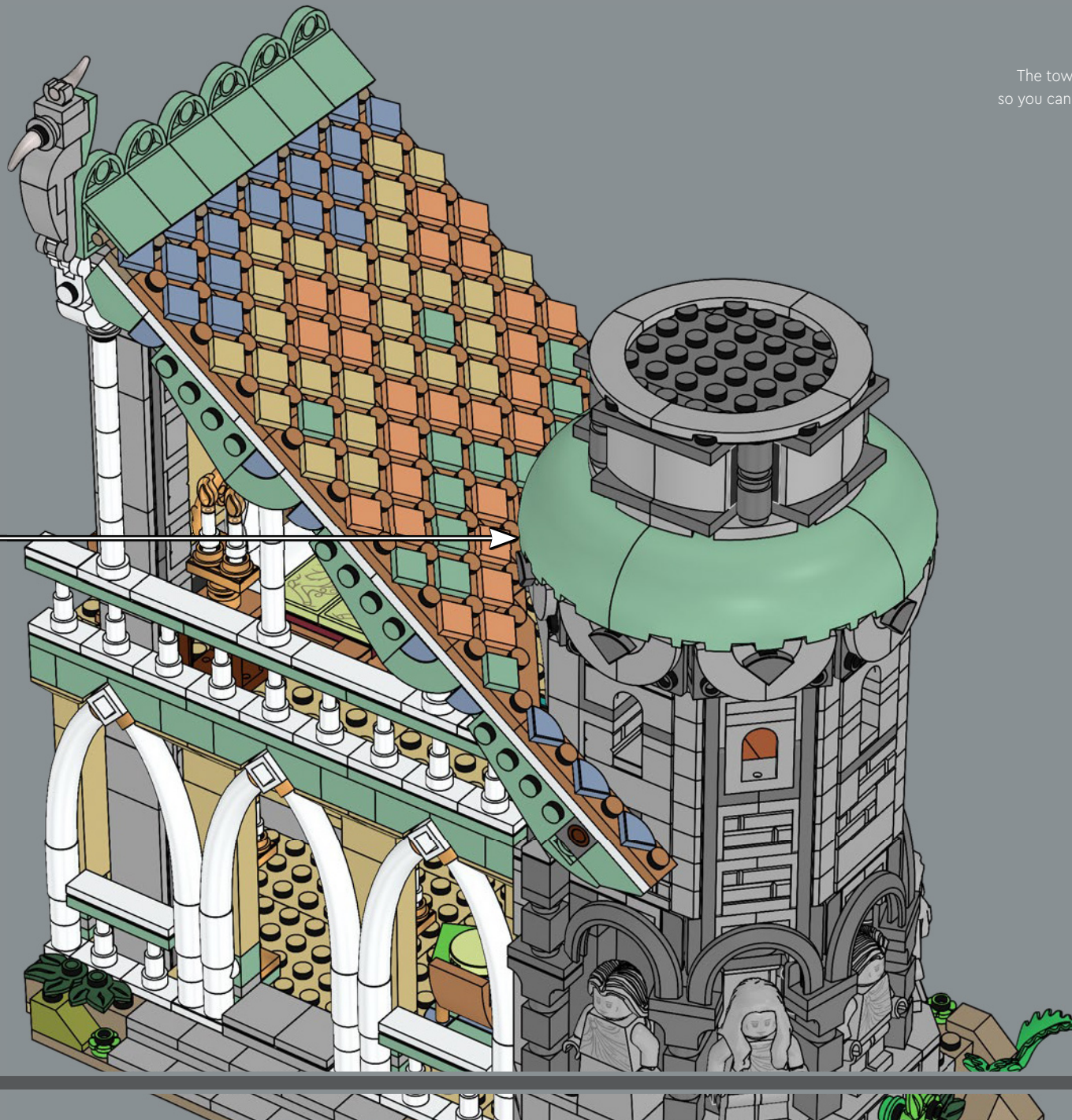

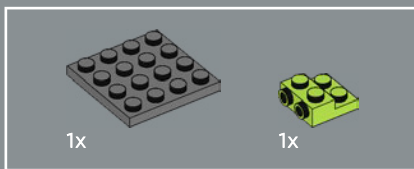

227

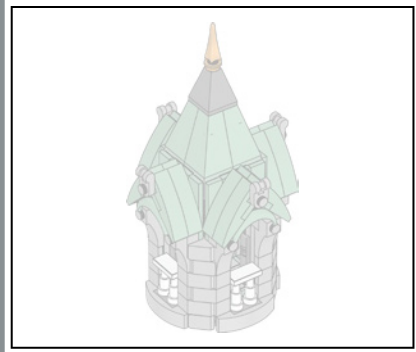
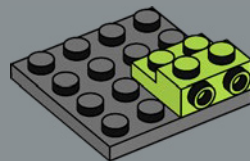

228

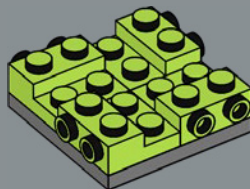

229

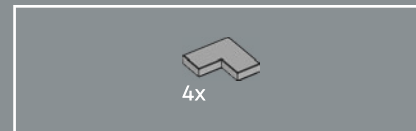
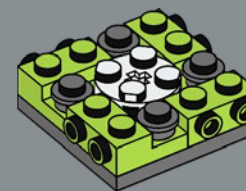

230

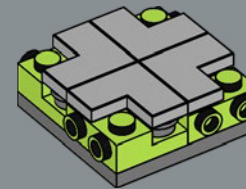



4x

231

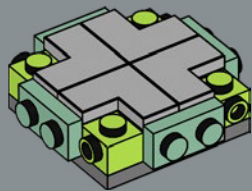

4x

8x

8x

4x

232

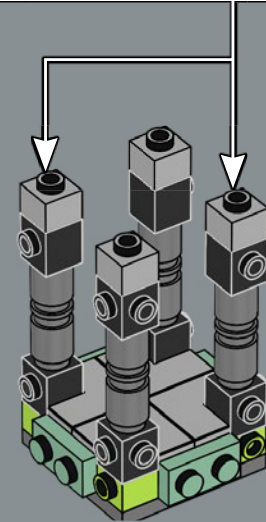
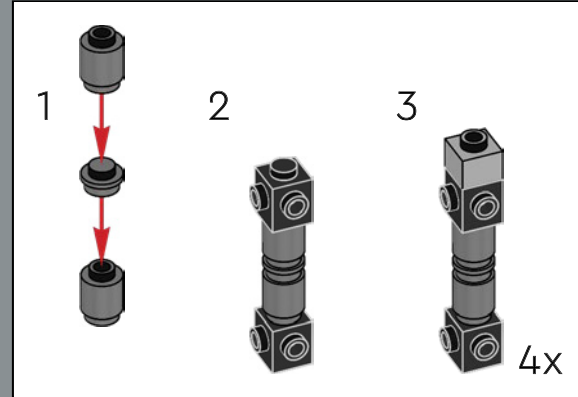

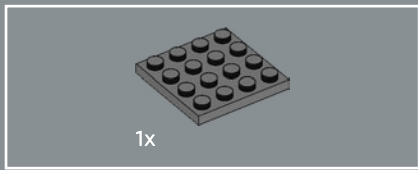

233

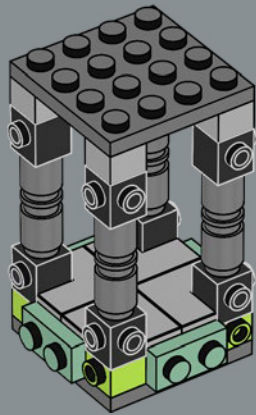

234

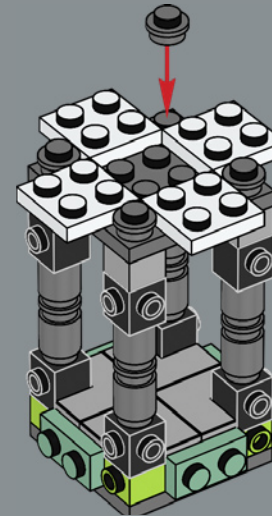

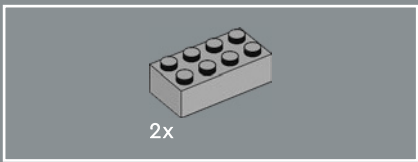

235

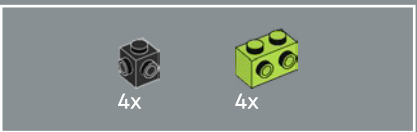
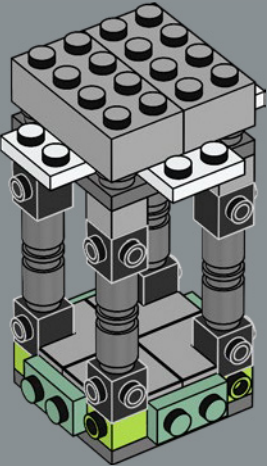

236

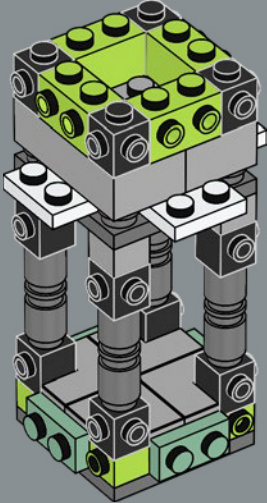



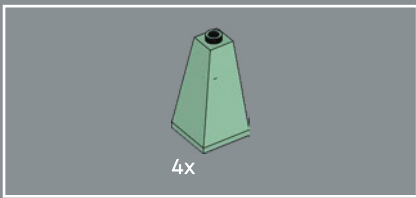

237

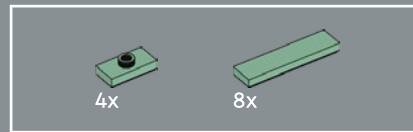
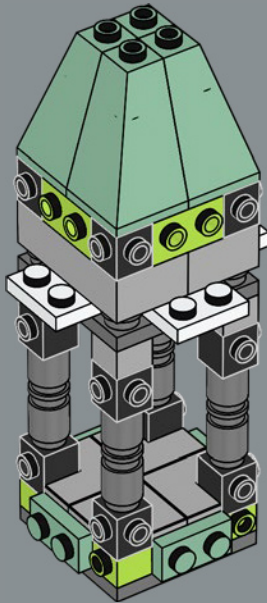

238

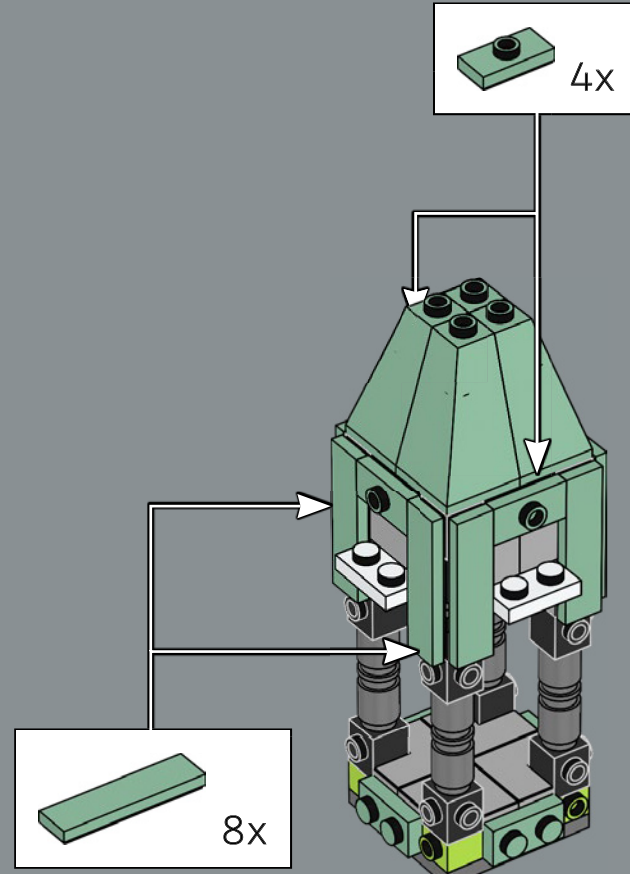

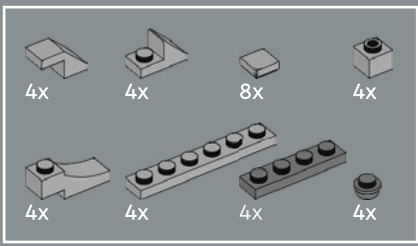

239

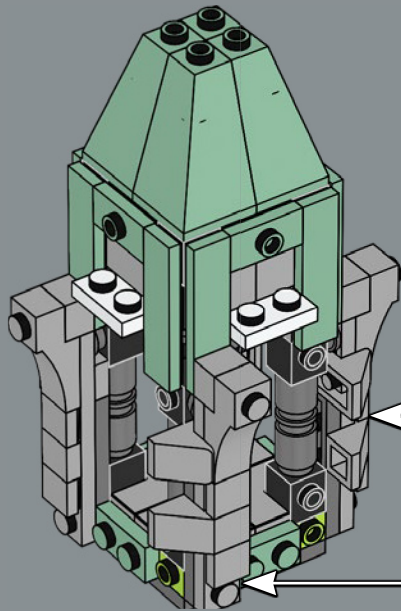
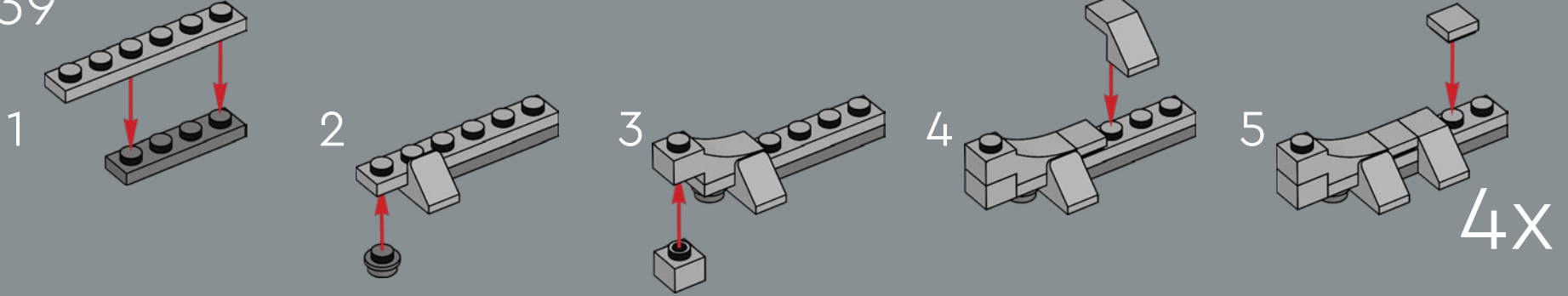

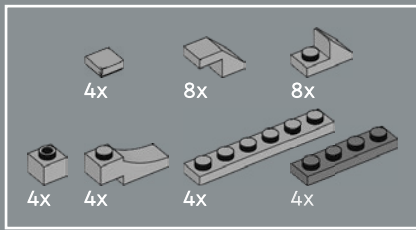

240

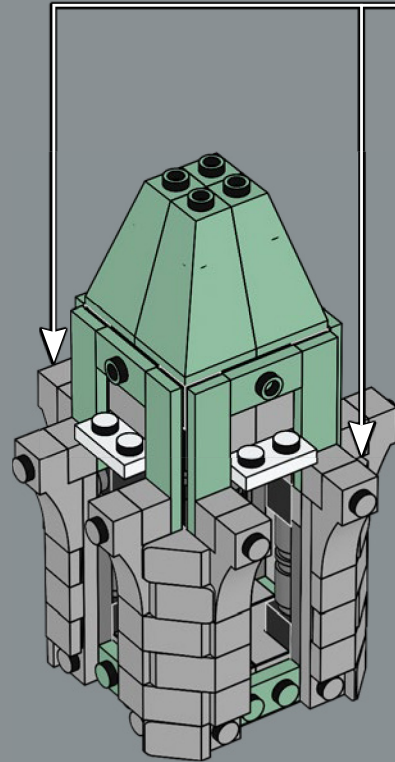
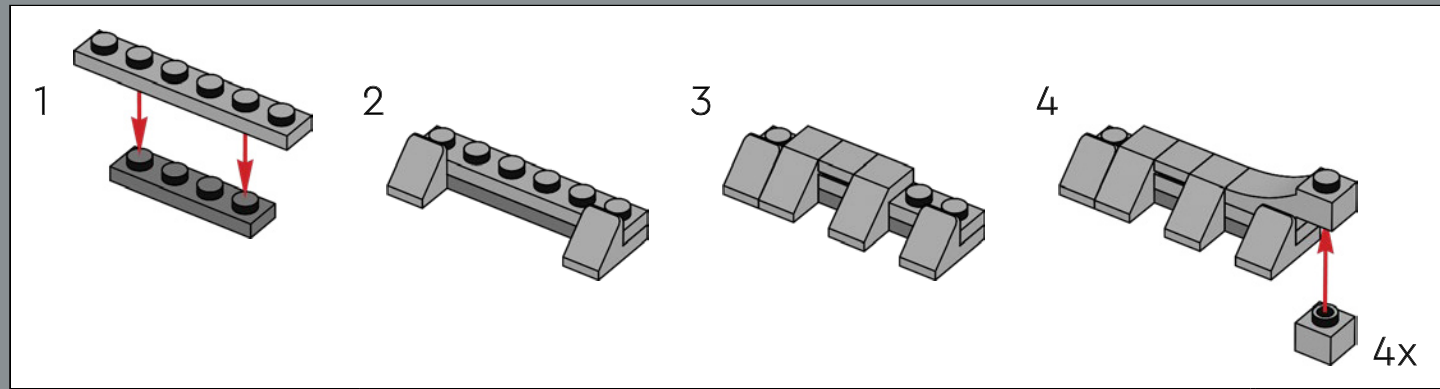



241

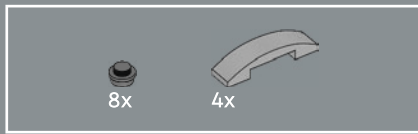
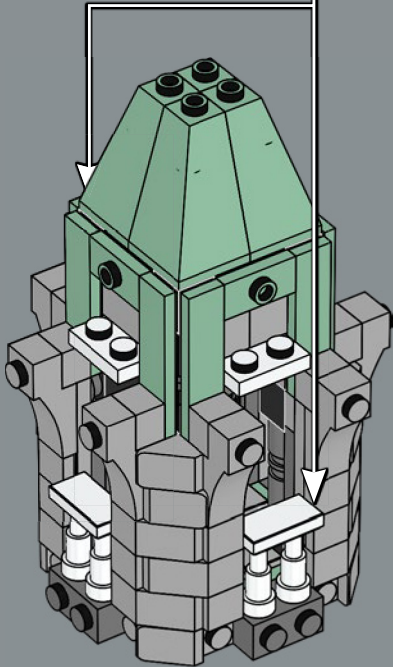
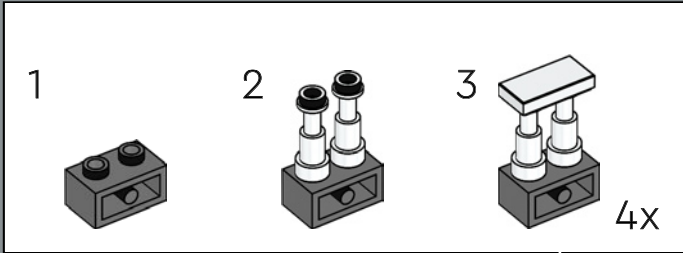

242

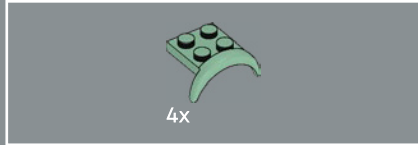
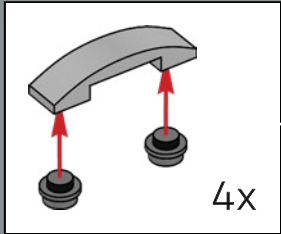

243

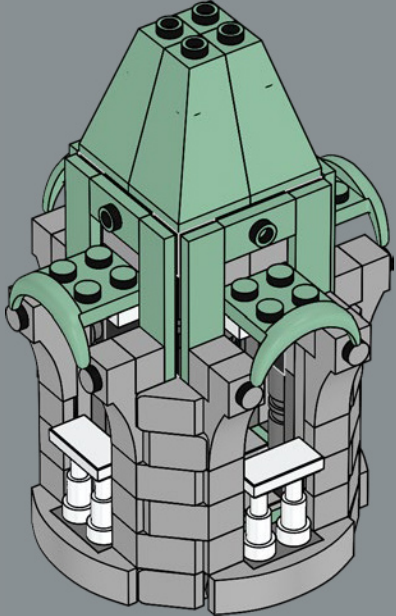
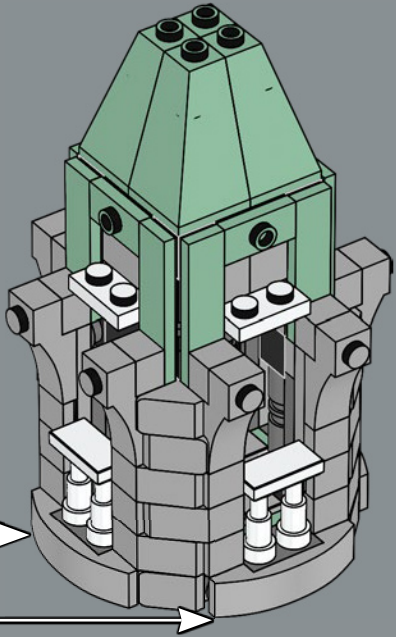

The green element used as the top of this window arch was originally developed as a wheel arch for a car.

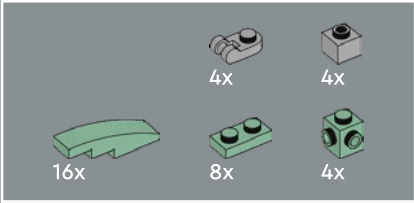

244

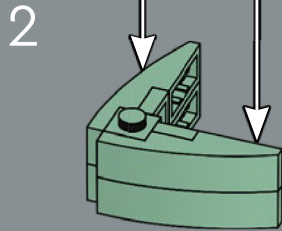
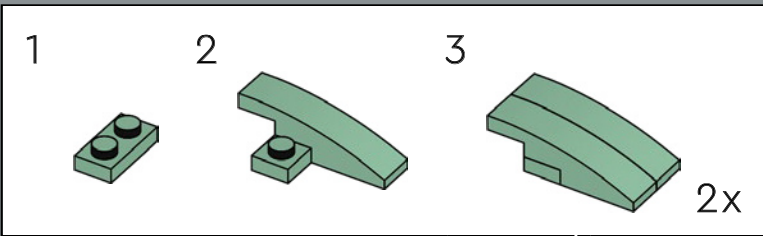
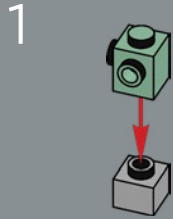

3

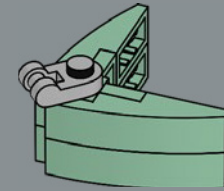

4x

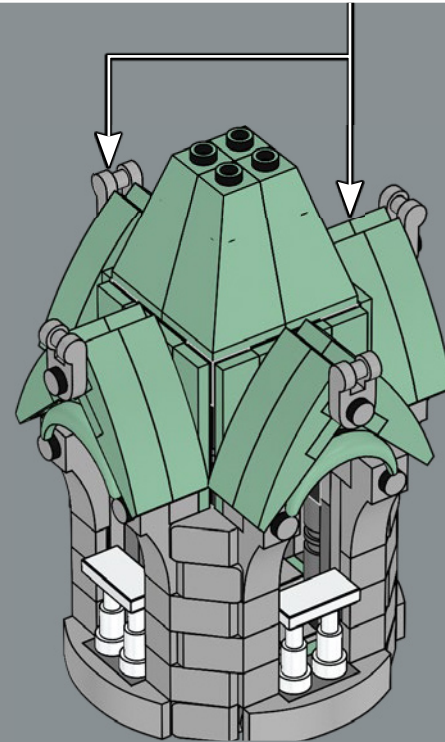



245

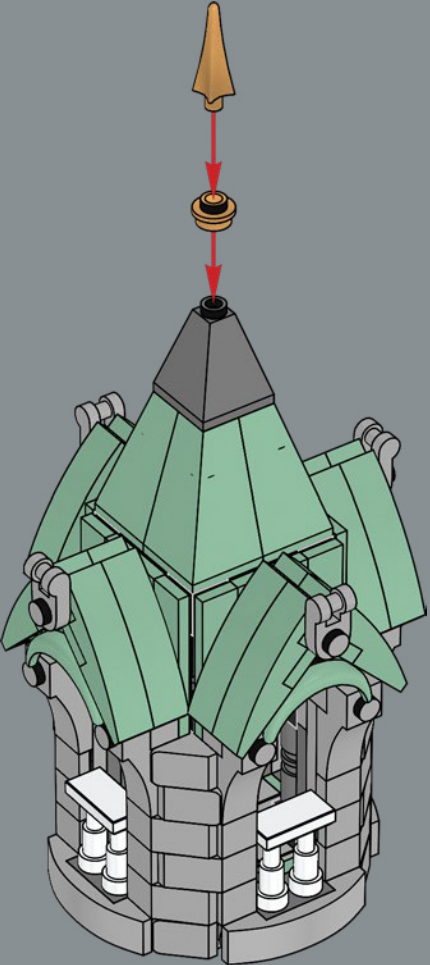

246

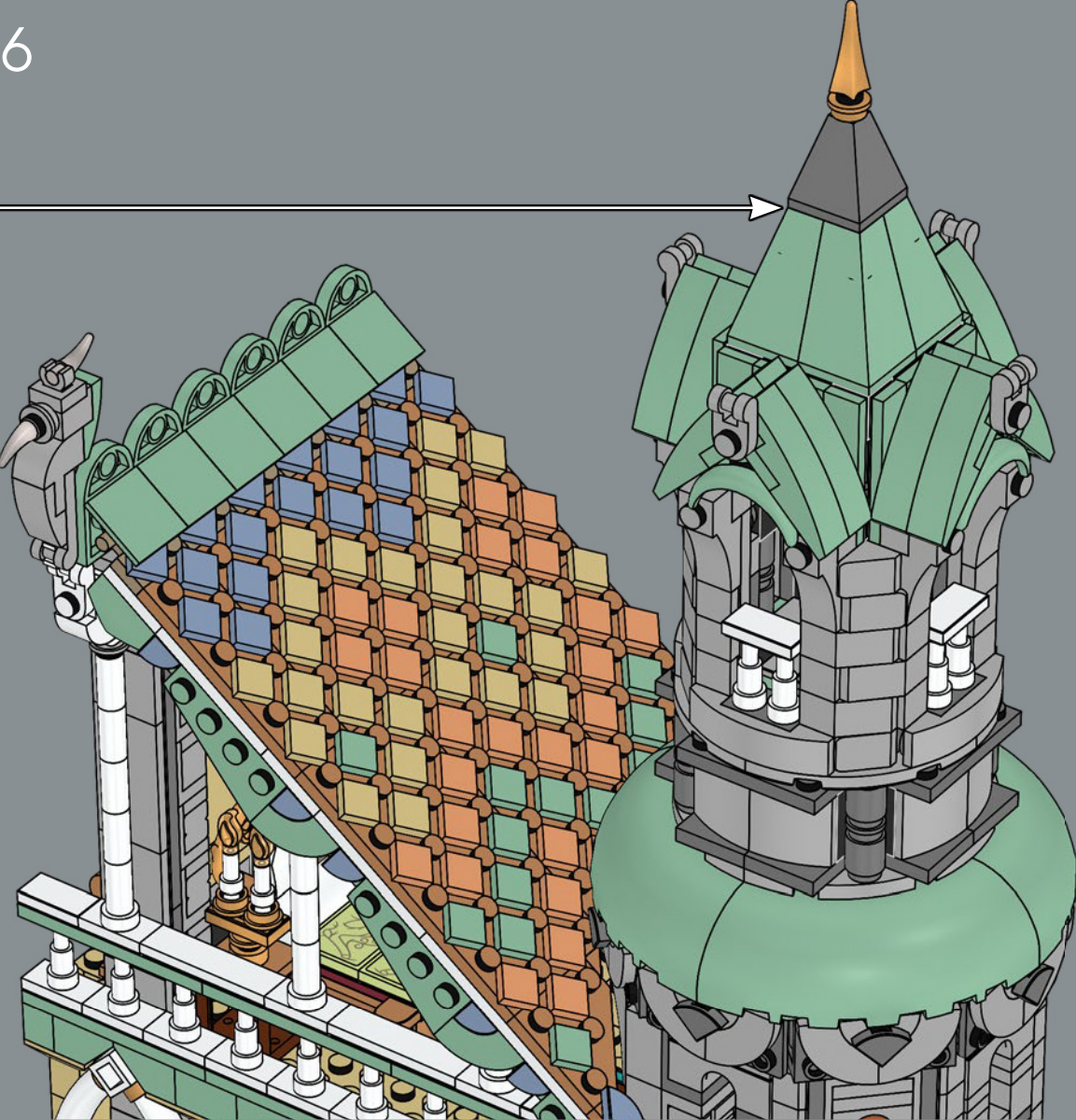

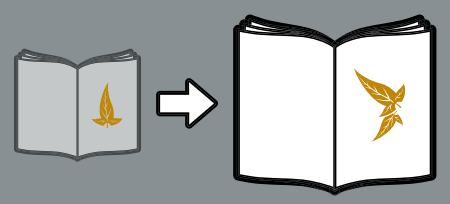

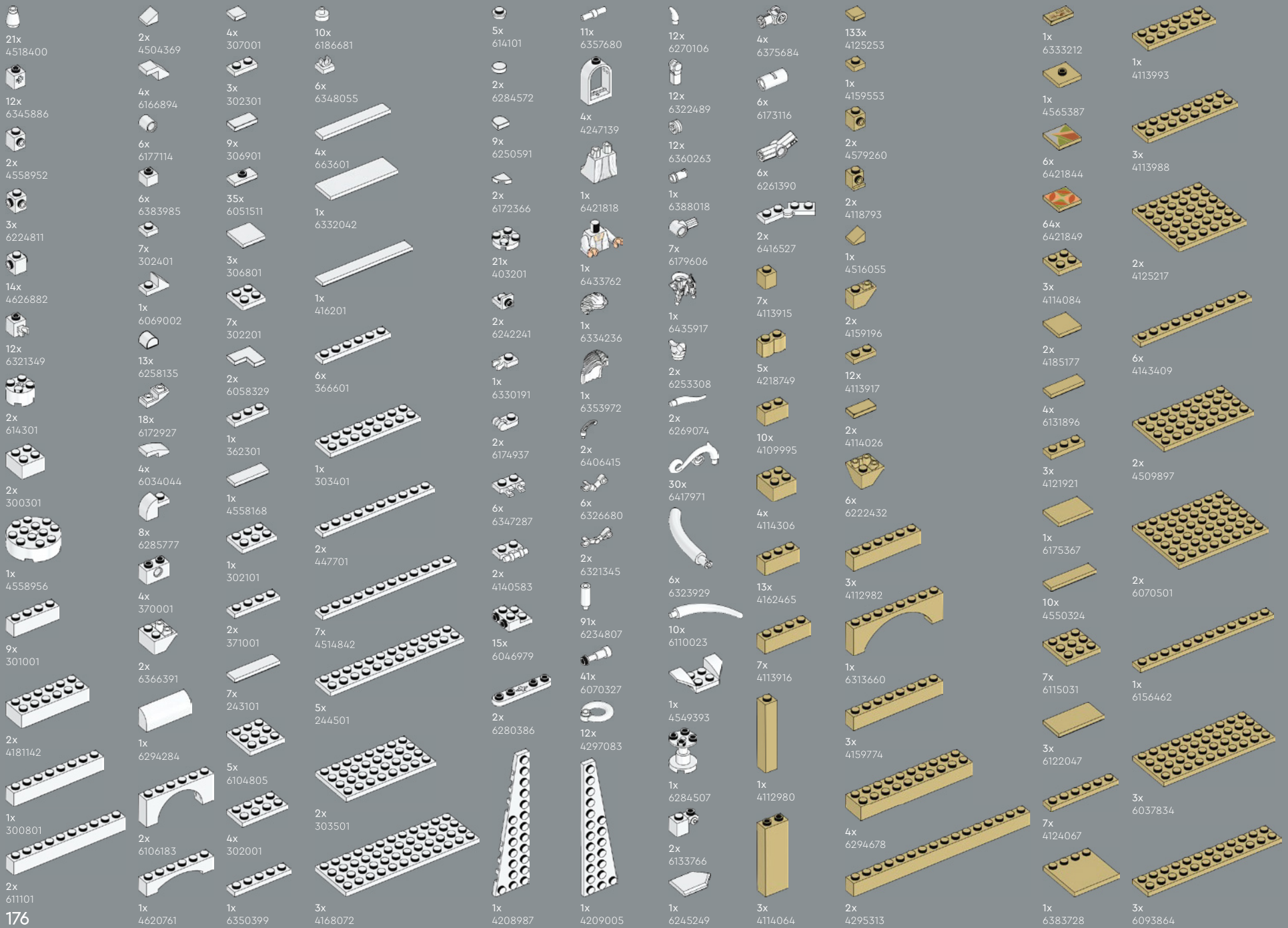



- 5x 4666579
- 2x 6145570
- 1x 6236914
- 1x 4512688
- 4x 6273864
- 3x 4624185
- 4x 6030980
- 2x 4611414
- 1x 6310249
- 1x 6433765
- 3x 6429962
- 7x 6421843
- 1x 306921
- 2x 6347308
- 1x 6187620
- 1x 6001806
- 1x 6066342
- 2x 6378120
- 18x 4142865
- 1x 6209519
- 5x 243121
- 5x 6129995
- 3x 6330584
- 130x 6419170
- 2x 6330418
- 2x 614323
- 2x 370023
- 2x 302323
- 2x 302123
- 1x 4206482
- 1x 6299413
- 4x 300823
- 1x 235724
- 2x 362324
- 1x 302024
- 2x 300224
- 1x 300824
- 6x 614124
- 72x 6286830
- 1x 346024
- 2x 6130008
- 2x 4558954
- 2x 6228987
- 4x 407026
- 19x 300226
- 1x 300926
- 1x 4181144
- 9x 6037390
- 2x 611226
- 6x 614124
- 2x 6286830
- 1x 346024
- 2x 6130008
- 2x 4558954
- 2x 6228987
- 4x 407026
- 19x 300226
- 1x 300926
- 1x 4181144
- 9x 6037390
- 2x 611226
- 1x 4504382
- 2x 6265091
- 4x 6170566
- 12x 6187572
- 1x 4214559
- 8x 473326
- 20x 6275806
- 5x 6138173
- 4x 6178922
- 1x 6039347
- 3x 302026
- 2x 366626
- 3x 379526
- 1x 4504382
- 2x 6265091
- 4x 6170566
- 12x 6187572
- 1x 4214559
- 8x 473326
- 20x 6275806
- 5x 6138173
- 4x 6178922
- 1x 6039347
- 3x 302026
- 2x 366626
- 3x 379526
- 3x 6186675
- 1x 6335388
- 1x 6330189
- 2x 6347310
- 1x 6338799
- 3x 6020193
- 1x 6016172
- 2x 6250020
- 2x 6313191
- 7x 346026
- 1x 395826
- 1x 303626
- 5x 6001494
- 1x 6186664
- 40x 614126
- 1x 474026
- 2x 6195325
- 10x 6052126
- 1x 452826
- 6x 6371584
- 6x 6116604
- 1x 6267045
- 6x 6168620
- 2x 6280168
- 1x 4558209
- 1x 6115117
- 4x 6401209
- 1x 6133200
- 1x 452226
- 1x 4189009
- 1x 6315887
- 3x 6278152
- 5x 6279875
- 8x 6280097
- 6x 4512363
- 5x 6390386
- 2x 6227901
- 1x 6315573
- 1x 6283610
- 1x 4517986
- 1x 6399780
- 6x 302128
- 1x 6299492
- 1x 6321770
- 1x 6171101
- 15x 6229130
- 2x 6331100
- 46x 6206150
- 4x 4119479
- 15x 6182261
- 1x 6235080
- 34x 6411022
- 16x 6268814
- 2x 6389695
- 1x 6406357
- 5x 6395814
- 1x 6293826
- 2x 6266964

5

4





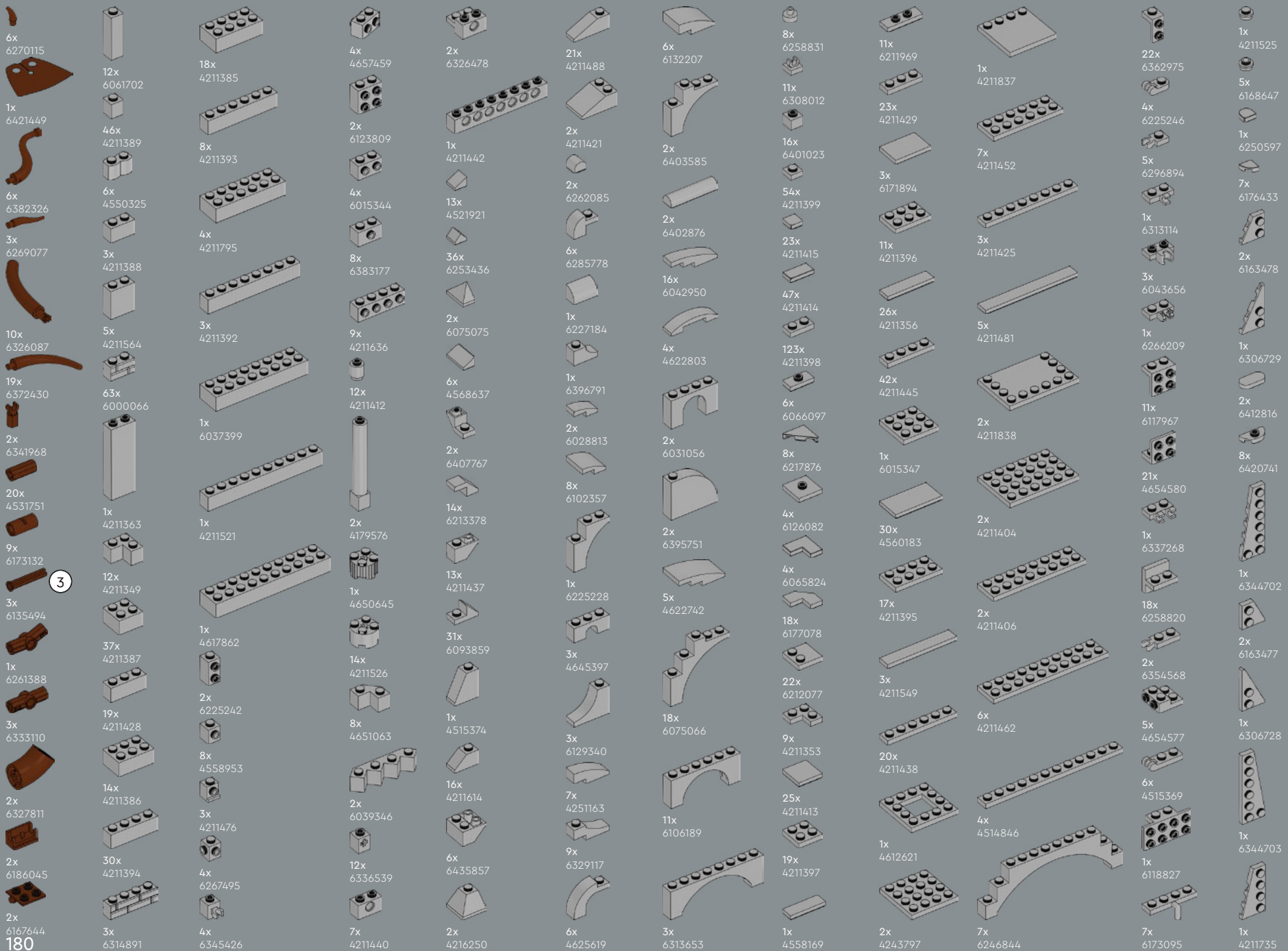

3



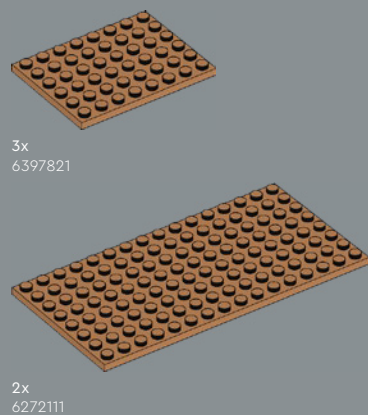
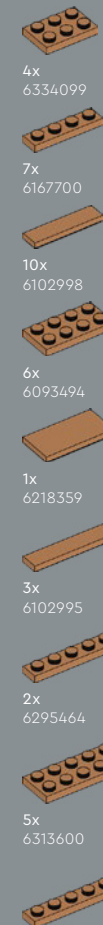
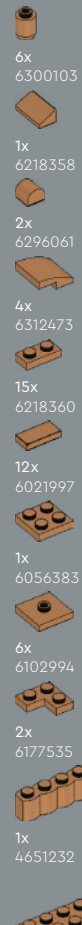

2x 6272111



6x 6346548

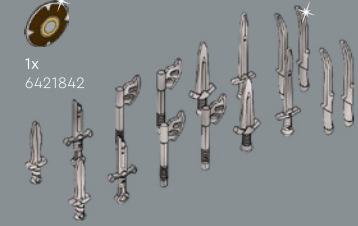
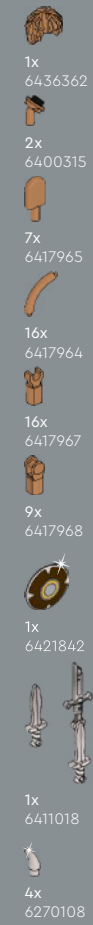

8x 6335549



47x 6064670



1x 6287309



LEGO.com/service



# YOU COULD WIN



## YOU COULD WIN

Your feedback will help shape the future development of this product series.

Visit:

## DU KÖNNTEST GEWINNEN

Dein Feedback trägt zur Weiterentwicklung dieser Produktreihe bei.

Geh auf:

## VOUS POURRIEZ GAGNER

Vos commentaires nous aideront à concevoir les futurs produits de cette gamme.

Visitez :

## POTRESTI VINCERE TU

La tua opinione ci aiuterà a migliorare la creazione futura di questa linea di prodotti.

Visita:

## PUEDES GANAR

Tu opinión contribuirá al futuro de esta serie de productos.

Visita:

## 轻松获奖

您的反馈将有助于我们在今后改进本产品系列。

请访问:

---

# LEGO.com/productfeedback

---

You also have the chance to win a LEGO® set.

Terms and conditions apply.\*

Außerdem hast du die Chance, ein LEGO® Set zu gewinnen.

Es gelten die Teilnahmebedingungen.\*

Vous pourriez également gagner un ensemble LEGO®.

Des conditions s'appliquent.\*

Hai anche la possibilità di vincere un set LEGO®.

Termini e condizioni sono applicabili.\*

También tienes la oportunidad de ganar un set LEGO®.

Aplican términos y condiciones.\*

您还有机会赢取乐高®套装。

条款和条件适用。\*

\*[LEGO.com/productfeedback-terms](https://www.lego.com/productfeedback-terms)

LEGO and the LEGO logo are trademarks of the LEGO Group. ©2023 The LEGO Group.

© 2023 New Line Productions, Inc. All rights reserved. The Lord of the Rings: The Fellowship of the Ring, The Lord of the Rings: The Two Towers, The Lord of the Rings: The Return of the King and the names of the characters, items, events and places therein are trademarks of The Saul Zaentz Company d/b/a Middle-earth Enterprises under license to New Line Productions, Inc. (s23)

